

## CHAPTER I

### PROCEDURE OF ESTIMATING

#### INTRODUCTION

For all engineering works it is required to know beforehand the probable cost of construction known as the estimated cost. If the estimated cost is greater than the money available, then attempts are made to reduce the cost by reducing the work or by changing the specifications. From this the importance of estimate for engineers may be understood. In preparing an estimate, the quantities of different items of work are calculated by simple mensuration method and from these quantities the cost is calculated. The subject of estimating is simple, nothing much to understand, but knowledge of drawing is essential. One who understands and can read drawing may find out the dimensions—lengths, breadths, heights, etc. from the drawing without difficulty and may calculate the quantities. The calculations mainly consist of, length  $\times$  breadth  $\times$  height or length  $\times$  breadth or length  $\times$  height. Student who is weak in drawing, if gives attention to estimating and prepares a few estimates from the drawings, will gain in power of understanding of drawing and his knowledge of drawing will be much improved. In preparing an estimate one has to go into details of each item, big or small, nothing can be left or missed. Estimating makes one thorough, superficial work does not do, one has to go deep into details. The subject of estimating cannot be prepared just before the examination, but preparation of a few estimates is essential.

There is no hard and fast rule for finding out the dimensions from the drawing (plans, elevations, sections, etc.) but for quick work certain principles, as explained in this book, may be followed. Beginners find it difficult to take out dimensions (length, breadth and height) from the plan, elevation and section, but they can easily find out the dimensions by measurements from the existing building. Foundation is more difficult for the beginners as it is not exposed and not visible. An estimator should picture the object (building, structure, etc.) in his mind from the study of drawing and specifications. Beginners, generally, find building easier to estimate than bridges, culverts, irrigation work, etc., as they are more familiar with different parts of building than those of other works. In fact the estimating of works other than building is simpler.

Accuracy in estimate is very important, if estimate is exceeded it becomes a very difficult problem for engineers to explain, to account for and arrange for the additional money. Inaccuracy in preparing estimate, omission of items, changes in designs, improper rates, etc. are the reasons for exceeding the estimate, though increase in the rates is one of the main reason. In framing a correct estimate, care should be taken to find out the dimensions of all the items correctly, and to avoid omissions of any kind of work or part thereof. The rate of each item should also be reasonable and workable. The rates in the estimate provide for the complete work, which consist of the cost of materials, cost of transport, cost of labour, cost of scaffolding, cost of tools and plants, cost of water, taxes, establishment and supervision cost, reasonable profit of contractor, etc.

Both standard brick 20 cm  $\times$  10 cm  $\times$  10 cm (nominal size) and traditional bricks 9"  $\times$  4"  $\times$  3" or 22.9 cm  $\times$  11.4 cm  $\times$  7.6 cm (nominal size) have been used in this book. The conventions and units of different items of works vary to some extent from state to state, though the units of the most of the items are same. An uniformity in units for all items of work should be maintained throughout the country based on the Indian Standard Institution. In preparing estimate the principle to be followed is to make each item or dimension clear and intelligible so that they can be understood, checked or verified by anybody. A remark column may be introduced and notes may be given where necessary.

## METRIC SYSTEM AND UNITS

Metric system is very simple as the units are multiples of ten or one-tenth of the other. The most important advantage of the metric system is the tremendous simplification of calculations. The adoption of the metric system has much simplified the arithmetical operations of addition, subtraction, multiplication and division, and also has saved much useful time being quicker. The foot pound system of calculations by fraction in almost all topics which is complicated, has been done away.

For Civil Engineering Works the units which are commonly used are—(i) Metre for length, (ii) Square metre for area, (iii) Cubic metre for volume, (iv) Kilogram for mass, and (v) Litre for capacity.

The sub-units are named by adding the suitable prefixes as milli (one thousandth), centi (one-hundredth) and deci (one-tenth). The multiple units are named by adding the prefixes as deca (ten times), hecto (hundred times) and kilo (thousand times).

The prefixes for formation of multiples and sub-multiples of units are as given below—

Prefix	Multiplying factor	Prefix	Multiplying factor
tera (T)	1000 000 000 000 = $10^{12}$	deci (d) 0.1	= $10^{-1}$
giga (G)	1000 000 000 = $10^9$	centi (c) 0.01	= $10^{-2}$
mega (M)	1000 000 = $10^6$	milli (m) 0.001	= $10^{-3}$
kilo (k)	1000 = $10^3$	micro ( $\mu$ ) 0.000 001	= $10^{-6}$
hecto (h)	100 = $10^2$	nano (n) 0.000 000 001	= $10^{-9}$
deca (da)	10 = $10^1$	pico (p) 0.000 000 000 001	= $10^{-12}$
		femto (f) 0.000 000 000 000 001	= $10^{-15}$
		atto (a) 0.000 000 000 000 001	= $10^{-18}$

## Illustrations

1 kilometre = 1 km =  $1 \times 10^3$  m = 1000 metre  
 1 kilogram = 1 kg =  $1 \times 10^3$  g = 1000 gram  
 1 kilo litre = 1 kl =  $1 \times 10^3$  l = 1000 litre

1 millimetre = 1 mm =  $1 \times 10^{-3}$  m = .001 m  
 1 milligram = 1 mg =  $1 \times 10^{-3}$  g = .001 gram  
 1 mili litre = 1 ml =  $1 \times 10^{-3}$  l = .001 litre

**Unit of mass and capacity** — In metric system there is simple relationship among these units—length, capacity and weight. The capacity of a cube whose side measures as one decimetre (one-tenth of a metre) is designed as 'litre' the standard unit of capacity. For practical purposes the weight of pure water contained in the same cube (cubic decimetre) is known as kilogram, the unit of mass. The weight of 1 cubic centimetre of pure water is one gram, 1000 gram is equal to one kilogram. Litre is the volume occupied by one kilogram of pure water at the temperature of its maximum density ( $4^\circ\text{C}$ ) and under normal pressure. The prototype of 'kilogram' is a platinum cylinder whose diameter and height are the same, viz. 39 mm.

**Square measure and cubic measure** — In engineering works square and cubic measures are very often required. Square metre and cubic metre are the standard unit for area and volume respectively. Square metre is the area equivalent to that of square of sides each equal to one metre. Cubic metre is the volume equivalent to that of a cube of sides each equal to one metre.

For conversion from FPS system to MKS system Indian Standard Institute has adopted — 1 yard = 0.9144 metre, or  
 1 metre = 1.09361 yard = 1.20044 ft

## INTERNATIONAL SYSTEM OF UNIT—SI UNIT

The Traditional Metric System (MKSA system — Metre, Kilogram, Second, Ampere System) does not include the unit of Thermodynamic temperature and the unit of Luminous intensity. The International Conference has adopted the International system of Units (System of International Unit — SI Unit) which includes six basic units covering all the units. The six basic units with their symbols are — Metre (m) for length, Kilogram (kg) for mass, Second (s) for time, Ampere (A) for electric current, Degree Kelvin (K) for thermodynamic temperature and Candela (Cd) for luminous intensity. The SI unit covers the co-herent units of the system (the basic units, supplementary units and the co-herent derived units and decimal multiples and sub-multiples of the units formed by the uses of the prefixes (See page 2). The co-herent units only are designated SI units.

A system of unit is co-herent if the product or quotients of any two units quantities in the system is the unit of the resultant quantity — for example, in any co-herent system, unit of area results when the unit length is multiplied by unit length; unit velocity when the unit length is divided by unit time; and unit force when the unit mass is multiplied by unit acceleration, etc. Whatever be the system of units and whether it be co-herent or non-co-herent, the magnitudes of some physical quantities must be arbitrarily selected and declared to have unit value. These magnitudes form a set of standard and are called 'basic unit.' All other units are derived units related to the basic units by definition.

Most of the advanced countries have adopted SI unit. Adoption of SI unit has little effect on the MKSA system as the four units of Metre, Kilogram, Second and Ampere, remain the same and only two more independent basic units have been added.

## BASIC SI UNITS

1. **Units of Length — Metre (m).** — The metre is the length equal to 1650 673.73 wavelengths in vacuum of the radiation corresponding to the transition between the levels  $2p_{10}$  and  $5d_5$  of the Krypton 86 atom.

2. **Unit of Mass—Kilogram (kg).** — The kilogram is the unit of mass and is equal to the mass of the international prototype of the Kilogram.

3. **Unit of Time — Second (s).** — The second is the duration of 9192 631 770 periods of the radiation corresponding to the transition between the two hyperfine levels of the ground state of the Caesium 133 atom.

4. **Unit of Electric Current — Ampere (A).** — The ampere is that constant current which, if maintained in two straight parallel conductors of indefinite length, of negligible circular cross-section, and placed one metre apart in vacuum, would produce between these conductors a force equal to  $2 \times 10^{-7}$  newton per unit length.

5. **Unit of Thermodynamic Temperature — Kelvin (K).** — The kelvin unit of thermodynamic temperature of the triple point of water.

*Note* — The kelvin may also be used for expressing a temperature interval. The degree Celsius ( $^\circ\text{C}$ ) is a unit of the International practical Temperature scale in which the thermodynamic temperature of zero point is 273.15 K. The degree Celsius is equal to kelvin ( $1^\circ\text{C} = 1\text{K}$ ). The degree Celsius may also be used for expressing a temperature interval.

6. **Unit of Luminous Intensity — Candela (cd).** — The candela is the luminous intensity, in the perpendicular direction, of a surface of  $1/600,000$  square metre of a black body at the temperature of freezing platinum, under a pressure of 101.325 newtons per square metre.

**Supplementary Units.** — In the International System of units, the quantities, plane angle and solid angle, are treated as independent quantities with SI units *radian* (rad.) and *steradian* (sr) respectively.

One radian is the angle between two radii of a circle which cuts off on the circumference an equal in length to the radius.

One steradian is the solid angle which having its vertex in the centre of a sphere, cuts off an area of the surface of the sphere equal to that of square with sides of length equal to the radius of the sphere.

**Derived Units** — The expressions for the derived SI units are stated in terms of the basic units, as the SI unit for velocity is metre per second (m/s). For some of the derived units, special name have been adopted together with special letters symbols, as the SI unit for force is *newton* (N), for energy is (J), for power is *watt* (W), etc. Some derived SI units are also expressed in terms of the units from which they are derived as the SI unit for area is *square metre* (m<sup>2</sup>) for volume is *cubic metre* (m<sup>3</sup>) for density is *kilogram per cubic metre* (kg/m<sup>3</sup>), etc.

Refer ISI publication — 'Guide to the use of International System (SI) Units, S.P. : 5-1968.'

### METHOD OF ESTIMATING

**Estimate.** — Before undertaking the construction of a project it is necessary to know its probable cost which is worked out by estimating. An estimate is a computation or calculation of the quantities required and expenditure likely to be incurred in the construction of a work. The primary object of the estimate is to enable one to know beforehand, the cost of the work (buildings, structures, etc). The estimate is the probable cost of a work and is determined theoretically by mathematical calculations based on the plans and drawing and current rates. Approximate estimate may be prepared by various methods but accurate estimate is prepared by *Detailed Estimate Method*.

**Actual Cost.** — The actual cost of a work is known at the completion of the work. Account of all expenditure is maintained day-to-day during the execution of work in the account section and at the end of the completion of the work when the account is completed, the actual cost is known. The actual cost should not differ much from the estimated cost worked out at the beginning.

**Detailed Estimate.** — Preparation of detailed estimate consists of working out the quantities of different items of work and then working out the cost i.e. the estimate is prepared in two stages:-

- (i) **Details of Measurements and Calculation of Quantities** — The whole work is divided into different items of work as earthwork, concrete, brick work, etc. and the items are classified and grouped under different sub-heads, and details of measurement of each item of work are taken out and quantities under each item are computed in prescribed form — *Details of Measurement Form*.

#### Details of Measurement Form —

Item No.	Description or Particulars	No.	Length	Breadth	Height or Depth	Content or Quantity

It is better to add one more column for total quantity or content.

- (ii) **Abstract of Estimated Cost.** — The cost under item of work is calculated from the quantities already computed at workable rate, and the total cost is worked out in a prescribed form, *Abstract of Estimate Form*. A percentage of 3 to 5 per cent is added for contingencies, to allow for petty contingent expenditures, unforeseen expenditures, changes in design, changes in rates, etc. which may occur during the execution of the work. A percentage of 1½ to 2 per cent is also added to meet the expenditure of work-charged establishment. The grand total thus obtained is the estimated cost of the work.

#### Abstract of Estimate Form—

Item No.	Description or Particulars	Quantity	Unit	Rate	Amount

In the above forms the description of each item should be such as to express exactly what work, material, proportions of mortar, etc. have been provided for.

In preparing an estimate items are usually classified and grouped sub-head wise but for beginners it is convenient to make up the items in the same order, as far as possible, as they would be executed or constructed. If the principle of following the order of construction from foundation to upward direction is followed there is little chance of omission of items.

Note— For different types of estimates, etc., see Chapter 10, 'Types of Estimates'.

### MAIN ITEMS OF WORK

**1. Earthwork.** — Earthwork in excavation and Earthwork in filling are usually taken out separately under different items, and quantities are calculated in cu m. Foundation trenches are usually dug to the exact width of foundation with vertical sides. Earthwork in excavation in foundation is calculated by taking the dimensions of each trench length × breadth × depth. Filling in trenches after the construction of foundation masonry is ordinarily neglected. If the trench filling is accounted, this may be calculated by deducting the masonry from the excavation.

Earthwork in plinth filling is calculated by taking the internal dimensions in between plinth wall (Length × Breadth) which are usually less than the internal dimensions of the room by two off-sets of plinth wall i.e. 10 cm (4½") and height is taken after deducting the thickness of concrete in floor, usually 7.5 cm (3"). If sand filling is done in plinth, this should be taken separately. The length and breadth for each filling may be same as the internal dimensions of the room if there is no off-set in plinth wall.

Excavated earth is used in trench filling and plinth filling and usually not paid for separately, but may also be included under a separate item — "Return fill and ram or backfill" and paid at a lesser rate. Extra earth if required for filling is brought from outside. If there is surplus earth after trench and plinth filling, this may be utilised in levelling and dressing of site or carted away and removed.

**2. Concrete in foundation.** — The concrete is taken out in cu m by length × breadth × thickness. The length and breadth of foundation concrete are usually the same as for excavation, only the depth or thickness differs. The thickness of concrete varies from 20 cm to 45 cm, usually 30 cm (9" to 18", usually 12"). Foundation concrete consists of lime concrete or weak cement concrete. The proportion of cement concrete in foundation may be 1 : 4 : 8 or 1 : 5 : 10.

**3. Soling.** — When the soil is soft or bad, one layer of dry brick or stone soling is applied below the foundation concrete. The soling layer is computed in sq m (Length × Breadth) specifying the thickness.

**4. Damp proof course.** — D.P.C. usually of 2.5 cm (1") thick rich cement concrete 1 : 1½ : 3 or 2 cm (¾") thick rich cement mortar 1 : 2, mixed with standard waterproofing material, is provided at the plinth level to full width of plinth wall, and the quantities are computed in sq m. (Length × Breadth). Usually D.P.C. is not provided at the sills of doors and verandah openings, for which deductions are made. (One kg of Cem-Seal or Impermo or other standard waterproofing compound per bag of cement is generally used).

**5. Masonry.** — Masonry is computed in cu m (Length × Breadth × Height). Foundation and plinth masonry is taken under one item, and masonry in superstructure is taken under a separate item. In storeyed building the masonry in each storey as ground floor above plinth level, first floor, etc. is computed separately. In taking out quantities the walls are measured as solid and then deductions are made for openings as doors, windows, etc. and such other portions as necessary. Masonry of different types or classes, masonry with different mortar, etc. are taken out under separate items. Arch masonry work is taken out separately. Splayed or rounded sides of wall are considered as rectangular and extreme dimensions are taken to find out the quantities. Thin partition wall is measured in sq m. Honey comb brick wall is taken under a separate item in sq m, no deduction is made for holes. Stone masonry is calculated in the same manner as for brick masonry.

**DEDUCTION FOR OPENING, BEARINGS ETC. IN MASONRY**

No deduction is made for the following:—

- (i) Opening each up to 1000 sq cm or 0.1 sq m (1 sq ft).
- (ii) Ends of beams, posts, rafters, purlins, etc. upto 500 sq cm or 0.05 sq m (72 sq in) in section.
- (iii) Bed plate, wall plate, bearing of chajjas and the like upto 10 cm (4") depth.

Bearings of floor and roof slabs are not deducted from wall masonry.

For other openings deductions are made in the following manner:—

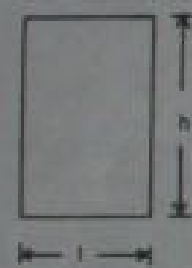

Fig. 1-1

**Rectangular Openings**—Full deduction is made.

Deduct —  $l \times h \times$  thickness of wall.

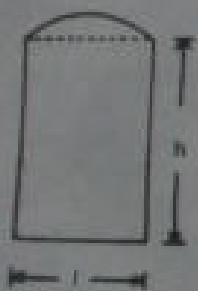

Fig. 1-2

**Doors and Windows with Small Segmental Arches**—

Deduction is made for rectangular portion only up to the springing line. The segmental portion is considered as solid to allow for the extra expenses in constructing the arch, and the filling up with thin wall.

Deduction —  $l \times h \times$  thickness of wall.

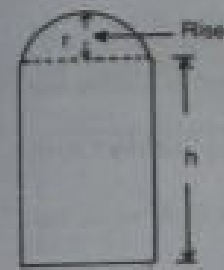

Fig. 1-3

**Segmental Arch Openings**—

Deduction is made for the whole opening, the rectangular portion as well as the segmental portion.

$$\text{The area of segmental portion} = \frac{2}{3}lr + \frac{r^2}{2l}$$

But for deduction, the area of the segmental portion is obtained approximately by taking 2/3 of span × rise, ( $\frac{2}{3} \times l \times r$ ) and the quantity for deduction is  $\frac{2}{3} \times l \times r \times$  thickness of wall, ( $r^2/2l$  being small is neglected for simplicity.)

The total deduction will be —  $[(l \times h) + (\frac{2}{3} \times l \times r)] \times$  thickness of wall.

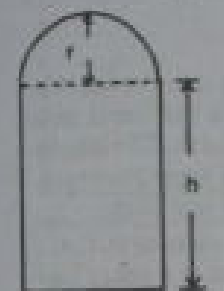

Fig. 1-4

**Semi-circular Arch Openings**—

The area of semi-circular portion =  $\frac{1}{2} \pi r^2$ .

But for the deduction, the area of the semi-circular portion is obtained approximately by  $\frac{1}{4}$  of span × rise, ( $\frac{1}{4} \times l \times r$ ).

The total deduction will be —  $[(l \times h) + (\frac{1}{4} \times l \times r)] \times$  thickness of wall.

**Elliptical arches** may be considered as semi-circular arches and may be dealt in the same manner.

For **Large Arches** the actual area of opening should be calculated correctly by mensuration formulae, and deduction should be made for actual area.

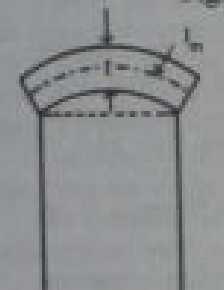

Fig. 1-5

**6. Arch masonry work**—Masonry work in arches is calculated in cu m separately by multiplying the mean length of the arch by the thickness of arch and by the breadth of the wall.

Quantity of arch masonry =  $l_a \times t \times$  thickness of wall.

Deduction =  $l \times t \times$  thickness of wall.

Calculation of arch work have been dealt in details in Chapter 2.

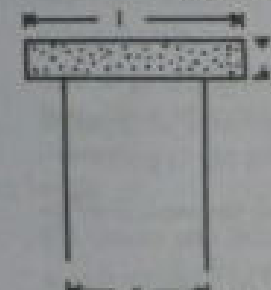

Fig. 1-6

**7. Lintels over openings.** — Lintels are either of R.C.C. or of R.B., quantities are calculated in cu m. Length of the lintel is equal to the clear span plus two bearings. If dimension of bearing is not given the bearing may be taken as same as the thickness of lintel with a minimum of 12 cm (4½"). Thus the length of the lintel,  $l = s + 2t$ , i.e. clear span plus two bearings.

Quantity of lintel =  $l \times t \times$  thickness of wall.

Deduction =  $l \times t \times$  thickness of wall.

**8. R.C.C. and R.B. work.**—R.C.C. and R.B. work may be in roof or floor slab, in beams, lintels, columns, foundations, etc. and the quantities are calculated in cu m. Length, breadth and thickness are found correctly from the plan, elevation, and section or from other detailed drawings. Bearings are added with the clear span to get the dimensions. The quantities are calculated in cu m exclusive of steel reinforcement and its bending but inclusive of centering and shuttering and fixing

and binding reinforcement in position. The reinforcement including its bending is taken up separately under steel works in quintal. For this purpose 0.6% to 1% (usually 1%) of R.C.C. or R.B. work by volume may be taken for steel, if other details are not given. The volume of steel is not required to be deducted from the R.C.C. or R.B. work.

R.C.C. and R.B. works may also be estimated inclusive of steel and centering and shuttering for the complete works, if specified.

Centering and shuttering (form work) are usually included in the R.C.C. or R.B. work, but may also be taken separately in sq m of surface in contact with concrete.

In R.C.C. work plastering is not taken separately, but the exposed surface are finished with thin rich cement sand mortar plastering to give smooth and even surface, which usually is not taken into consideration.

(For R.C.C. or R.B. work, See also Chapter 5).

### 9. Flooring and Roofing. —

(i) **Ground floor** — The base lime concrete and floor finishing of C.C. or stone or marble or mosaic, etc. are usually taken as one job or one item (combined in one item), and the quantity is calculated in sq m multiplying the length by the breadth. The length and breadth are measured as inside dimensions from wall to wall of superstructure. Both the works of base concrete and floor finishing are paid under one item.

(ii) **1st floor, 2nd floor etc** — Supporting structure is taken separately in cu m as R.C.C., R.B. etc. and the floor finishing is taken separately in sq m as 2.5 cm or 4 cm (1" or 1½") C.C. or marble or mosaic, etc. If a cushioning layer of lime concrete is given in between the slab and the floor, the cushioning concrete may be measured with the floor under one item or taken separately.

(iii) **Roof** — Supporting structure is taken separately in cu m and the lime concrete terracing is computed in sq m with thickness specified, under a separate item including surface rendering smooth. The compacted thickness of lime concrete terracing is 7.5 cm to 12 cm (3" to 4½") average. L.C. terracing may also be calculated in cu m with average thickness, (as in practice in U.P.).

The bearing of roof or floor slab is given same as the thickness of slab, usually 10 cm to 15 cm (4" to 6").

In case of tiled, galvanised iron sheet, or asbestos cement sheet roofing the roof coverings are taken out in sq m and measured flat including overlaps with all fittings, and supporting trusses and members are taken under separate item.

Floor of door sills and sills of opening, should also be taken into account. In the case of ground floor sills should be taken separately, as there is no lime concrete in sills.

**10. Plastering and Pointing.** — Plastering usually 12 mm (½") thick is calculated in sq m. For walls the measurements are taken for the whole face of the wall for both sides as solid, and deductions for openings are made in the following manner —

- No deduction is made for ends of beams, posts, rafters, etc.
- For small opening up to 0.5 sq m (5 sq ft) no deduction is made, and at the same time no additions are made for jambs, soffits and of sills of these openings.
- For openings exceeding 0.5 sq m (5 sq ft) but not exceeding 3 sq m (30 sq ft) deduction is made for one face only, and the other face is allowed for jambs, soffits and sills which are not taken into account separately.
- For openings above 3 sq m (30 sq ft) deduction is made for both faces of the opening, and the jambs, soffits and sills are taken into account and added.

As the outer jambs, etc. are much smaller than the inner ones, the deduction is usually made from the outer face.

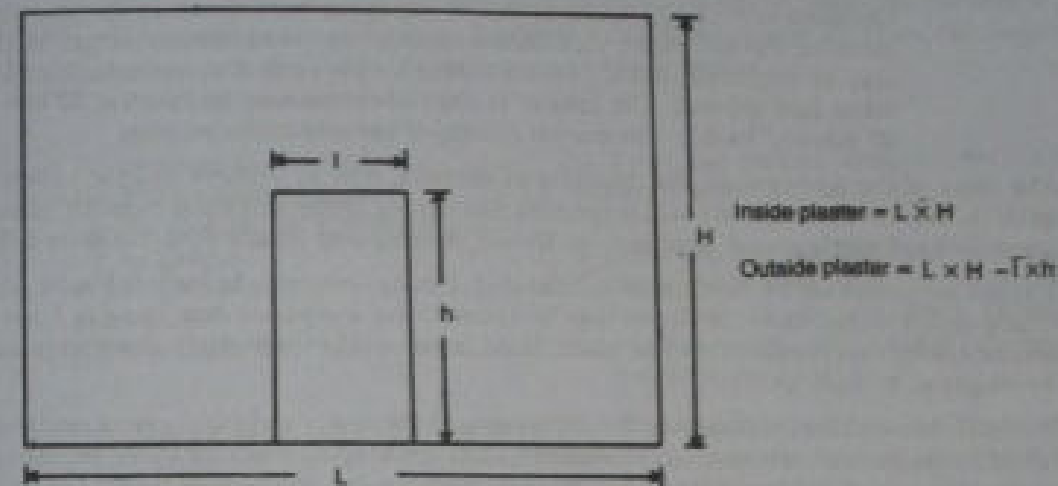

Fig. 1-7

For deduction for arch opening the same principle as for masonry work (pages 6-7) is followed. Plastering of ceiling usually of 12 mm (½") thick is computed in sq m under a separate head as this work is done with richer mortar. For R.C.C. work usually no plastering is allowed but for fair finish a thin plaster of rich cement mortar may be allowed which should not be taken in the measurement separately. Thin rich cement mortar plastering in R.C.C. work may also be taken under a separate item, specially in the ceiling inside room.

**Pointing.** — Pointing in walls is calculated in sq m for whole surface and deductions similar to plastering are made.

**11. Cornice.** — Ornamental or large Cornice is measured in running metre (running foot) for the complete work which includes masonry, plastering, mouldings, etc. and paid for in r m (r ft).

Similar, string course, drip course, cor-belling, coping, etc. are measured and paid for in running metre for the complete work.

**12. Pillars.** — Pillars are taken separately in cu m for their net volume and quantities are calculated by correct geometrical measurements by simple mensuration method.

$$\begin{aligned} \text{Quantity} &= \text{Sec. area} \times \text{ht.} = \frac{\pi d^2}{4} \times \text{ht. cu m for round pillars, } d \text{ is the dia,} \\ &= a^2 \times \text{ht. cu m for square pillars, } a \text{ is the side.} \end{aligned}$$

Hexagonal, octagonal, etc. pillars are dealt similarly.

Plastering in the pillars are calculated in sq m multiplying the circumference of perimeter by the height.

### 13. Doors and Windows. —

- Chowkhat or Frame.** — Door and window frames or chowkhats are computed in cu m. Length is obtained by adding the length of all the members of the chowkhat, top and two verticals if there is no sill member, and adding bottom also if there is sill, and this length is multiplied by the two dimensions of the cross-section of the member. If there is horn projection these projections also should be added to the length. If there is no sill member, vertical members should be inserted into the floor by about 2.5 cm to 4 cm (1" to 1½").

- (ii) *Door or Window Leaves or Shutters.* — They are computed in sq m by multiplying the breadth by the height of the shutters, the rebates in the chowkhat should be taken into consideration in finding the breadth and the height. A clearance of 6 mm ( $\frac{1}{4}$ " ) may be allowed at the bottom of door if there is no sill member. For estimating the clearance may not be taken into consideration, this may be neglected. But for measurement for payment the clearance should be taken into account. The rebates in the chowkhats may be taken as 12 mm to 20 mm ( $\frac{1}{2}$ " to  $\frac{3}{4}$ " ). The central overlap is not taken into account.

The name of the timber used, the thickness of shutters, type of shutters and the nature of fittings (iron, brass, etc.) should be noted in the item. Shutters of different types as panelled, glazed; partly panelled and partly glazed, venetian, etc. should be computed separately as the rates differ.

Fittings are computed by number *i.e.* enumerated. Fittings may also be included in the sq m rate of shutters. For estimate, the fitting may be taken under a separate item in sq m basis of shutters, or a lump sum provision may be made. Hold fasts are taken separately under a separate item by weight or by number.

It is better to purchase the fittings by the department to the choice and requirement, and to get them fitted by the contractor whose rate for shutters shall include the labour for fixing the fittings. In such case the rate of shutters will exclude the cost of fittings but will include the cost of fixing them. In estimating the cost of fittings will be provided under a separate item 'fittings of doors and windows' on area basis or on lump sum basis for the purchase of fitting.

**14. Wood Work.** — Wooden beams, burgahs, posts, wooden roof trusses, chowkhats, etc. come under this item, and the quantities are computed in cu m. The dimensions of finished work shall be taken.

**15. Iron Work.** — This is computed in weight in kg or quintal and the quantities are calculated correctly by multiplying the weights per running metre by the length. The weight per r m can be obtained from the steel section book (steel tables are given at the end of the book). For steel joint the length is equal to the clear span plus two bearings, the bearing may be taken  $\frac{3}{8}$  thickness of wall or 20 cm to 30 cm (8" to 12")

Density of mild steel is equal to 7850 kg/cu m or 78.5 q/cu m or 0.785 gram/cu cm (490 lbs/cu ft).

Weight of iron hold fasts may be taken as 1½ kg. (2 lbs to 2½ lbs) each. For doors 6 hold fasts (three on each side), and for windows 4 hold fasts may be provided if not specified.

The weight of bolts and nuts and rivets with heads can be calculated by counting their numbers and sizes and consulting steel table. Sometimes certain percentage of the whole steel work is provided for rivets and bolts and nuts. For steel roof truss 5 per cent of the steel work is usually provided for rivets and bolts and nuts.

**16. White-washing or Colour-washing or Distemping.** — The quantities are computed in sq m and are usually same as for plastering. The inside is usually white washed or distemped and this item will be same as for inside plaster. The outside is colour-washed and the quantities of colour-washing will be same as for outside plaster. These items need not be calculated separately, but simply written as same as for inside plaster or outside plaster. Number of coats of white-washing or colour-washing are taken as one job or work and the rates cover for the number of coats which should not be a multiplying factor. The number of coats should be mentioned in the item. Deductions are dealt in the same manner as for plastering. Other type of surface finishing may also be done and may be taken accordingly.

**17. Painting.** — Painting or Varnishing of doors and windows are computed in sq m, the dimensions should be taken for outer dimensions of the chowkhat *i.e.* outer dimensions of doors and windows. The area is measured flat (not girthed). No separate measurement is taken for the chowkhat, the area is same as the area of wall opening. For iron bars, grills, etc. the area of the clear opening inside the chowkhat is taken. For both faces of doors and windows, the simple area as measured above is multiplied by appropriate numbers as below —

(i) Panelled, framed and braced ledged and battened or ledged battened and braced	... 2½ times one surface area, for both sides.
(ii) Fully glazed or gauged	... 1 time one surface area, for both sides.
(iii) Partly panelled and partly glazed or gauged	... 2 times one surface area, for both sides.
(iv) Flush door	... 2 times one surface area, for both sides.
(v) Venetian	... 3 times one surface area, for both sides.
(vi) Iron bars, grills in windows	... 1 time the area of clear opening in between chowkhat for over all.

This covers also for chowkhats on three faces. Painting is done in two or three coats, usually over a coat of priming. The rate covers for the number of coats under one item. The number of coats should be mentioned in the description of item.

(The multiplying factors differ slightly from State to State. IS 1200 should be followed). For U.P. consult U.P., P.W.D., S.I.

The concealed surface of the chowkhat which is in contact with the jamb of the wall is usually painted with two coats of coaltar or solignum, and this item is computed separately.

For beams, rafters, purlins, posts, etc., of timber or iron, the area of actual exposed surface is taken for painting.

Corrugated surface is taken as flat and a percentage increase is allowed. (See Chapter 14 on *Methods of Measurement*).

**Lump-sum Item.** — Sometimes a lump-sum rate is provided for certain small items for which detailed quantities cannot be taken out easily or it takes sufficient time to find the detail, as front architectural or decoration work of a building, fire-place, site cleaning and dressing, etc.

**Other Items.** — For other items the units of different works given in pages 14 to 23 may be consulted. The units being known, it will not be difficult to estimate the quantities of different items of work.

**Electrification and Sanitary and Watersupply Works.** — For Sanitary and Water supply Works 8% and for Electrification 8% of the estimated cost of the building works are usually provided in estimate.

**Nomenclature of Items.** — The nomenclature of items are fully described so that each item is clear and there is no ambiguity. Type and quality of materials, proportion of mortar, method of construction, etc. are included in the description of the items. Nomenclatures of item in the solved examples in this book are given in brief, for detailed nomenclatures, P.W.D. Schedule of rates may be consulted.

**Rates.** — Rates of different items in the estimate are the current rates for the completion of the items of work which include supply of materials, transport, labour scaffolding, overheads, contractor's profit, taxes etc. The rates are usually taken from the "P.W.D. Schedule of Rates."

**Reducing Calculation.** — There are certain items where calculation can be reduced, and time and labour saved, by adopting the following methods :—

1. **Foundation Concrete** =  $\frac{\text{Quantity of earthwork in excavation in foundation}}{\text{Depth of excavation}} \times \text{thickness of concrete}$

For example, if the depth of excavation is 90 cm and the thickness of concrete is 30 cm, then concrete =  $\frac{1}{3} \times$  Quantity of earthwork.

This is true only when the depth of excavation and the thickness of concrete are same for all walls if not same take by parts whose depths are same.

2. **Sand Filling in Plinth** =  $\frac{\text{Quantity of earth filling in plinth}}{\text{Height of earth filling}} \times \text{Height of sand filling}$ .

For example, if height of earth filling in plinth is 60 cm and the height of sand filling is 30 cm, then the quantity of sand filling =  $\frac{1}{2} \times$  Quantity of earth filling.

Instead of sand filling, cinder is also used in filling the upper part of the plinth, which may be dealt in the same manner as that of sand filling.

3. **Inside White-washing** — Quantity is same as for inside plastering. Simply write 'the same area as for inside plastering'.

4. **Outside Colour-washing** — Quantity is same as for outside plastering. Simply write 'the same area as for outside plastering'.

5. **Masonry Work in Footings**. — When there are number of footings, the average breadth may be taken and the quantity may be calculated by multiplying by the length and height.

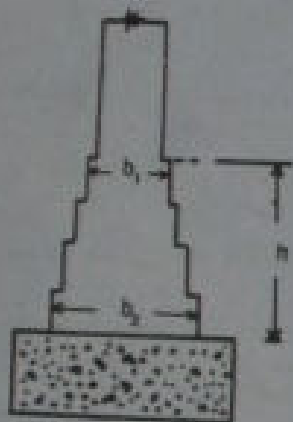

Average breadth =  $\frac{b_1 + b_2}{2}$

Quantity of masonry to the footing =  $L \times \frac{b_1 + b_2}{2} \times h$ .

Quantity thus obtained is only approximate but may be sufficient for practical purposes.

Length L should be mean length or centre line length.

6. To save multiplication against every line combine those whose breadth and height are common, add the length of all and multiply by the common breadth and height. By adopting this method many multiplications can be avoided.

For example —

Item No.	Description of Item	No.	L.	B.	Ht.	Quantity
	Brick masonry in super-structure	2	7.65 m	.30 m	3.60 m	
		3	3.50 m	.30 m	3.60 m	
		2	3.80 m	.30 m	3.60 m	
		1	4.20 m	.30 m	3.60 m	
Total ...			37.60 m	.30 m	3.60 m	= 40.608 = 40.61 cu m

**Degree of Accuracy in Estimating.** — The accuracy, to be observed in preparing an estimate depends on the rate of the item and the unit of payment. The higher the rates the greater should be the accuracy with which the quantities are calculated. Where rates are high and paid per unit, dimensions should be absolutely correct, though taking dimensions to the nearest 1 cm to .5 cm ( $\frac{1}{2}$ " to  $\frac{1}{4}$ " ) may be allowed for practical purposes. The quantities in such cases should be worked out to at least two places of decimal. But where rates are low and paid for  $\frac{1}{100}$  to  $\frac{1}{1000}$  unit such extreme accuracy is not required.

In the case of wall where masonry is paid per cu m a few cm added to or subtracted from the length or height would but little affect the total content. But the width or thickness of the wall, where every half cm or quarter cm affects the result considerably should be taken out with great accuracy. The quantities may be computed to the nearest two places of decimal.

In general, dimensions should be measured to the nearest 1 cm (.01 m), areas should be worked out to the nearest 0.01 sq m and cubic contents should be worked out to the nearest to 0.01 cu m. Thickness of slabs, partitions, etc. and sectional dimensions of columns, pillars, beams, etc. should be taken to the nearest half centimetre (.005 m).

(See also Chapter 14 — Rules and Methods of Measurements and Taking out Quantities).

**UNITS OF MEASUREMENTS IN METRIC SYSTEM**

The principle for dimensions and measurements is to use millimetre (mm) for minute dimensions, centimetre (cm) for small dimensions and metre (m) for big dimensions. Distances are measured in kilo metre (km).

The dimensional units for main item of materials and works for general construction works as used in metric system are as follows :—

**Units of Dimensions for Materials and Works —**

Particulars of Materials and Works	Dimensions Metric System
1. Bricks, stone blocks, etc.	... All dimensions cm.
2. Files, slates, wall board, glass panes, A.C. sheets, sheets, etc.	... Length and breadth in cm or m. ... Thickness in mm.
3. Door, windows, etc.	... Height and breadth in cm or m.
4. Parts of doors and windows as pannels, shutters	... cm or mm.
5. Timber	... Length in m and cross-sectional dimensions in cm, or mm.
6. Masonry (brickwork, stone masonry, etc.)	... Length and height in m. ... Thickness or breadth in cm.
7. Cement concrete, Lime concrete, R.C.C. Flooring, etc.	... Length and breadth in m. ... Thickness in cm.
8. White washing, Colour washing, Distemping, Painting, etc.	... Length and breadth or height in m.
9. Aggregates, t allast, grit, sand, etc.	... Size in mm.
10. Rolled steel sections as l-beam, channel, angle, etc.	... Length in m, section in mm.
11. Mild steel bars	... Length in m, Dia. in mm.

**Principle of Units for Various Items of Works —**

The units of different works depend on their nature, size and shape. In general, the units of different items of work are based on the following principle:—

(i) Mass, voluminous and thick works shall be taken in cubic unit or volume. The measurements of length, breadth and height or depth shall be taken to compute the volume or cubic contents.

(ii) Shallow, thin and surface works shall be taken in square unit or in area. The measurement of length and breadth or height shall be taken to compute the area.

(iii) Long and thin work shall be taken in linear or running unit, and linear measurement shall be taken.

(iv) Piece work, job work, etc., shall be taken in number.

The units of payments and measurements of various items of work in metric system are same except for earthwork. Earthwork is measured in cu m but payment is made per 100 cu m (per % cu m).

**THE UNITS OF MEASUREMENTS AND PAYMENTS FOR VARIOUS ITEMS OF WORKS AND MATERIALS**

Sl. No.	Particulars of Items	Units of measurement in MKS	Units of payment in MKS	Units of payment in FPS
<b>Earthwork —</b>				
1.	Earthwork in excavation in ordinary soil, earthwork in mixed soil with kankar, bajri, etc. earthwork in hard soil	cu m	per % cu m	% cu ft
2.	Rock excavation	cu m	per % cu m	% cu ft
3.	Earthfilling in excavation in foundation	cu m	per % cu m	% cu ft
4.	Earthfilling in foundation trenches (Usually not measured and not paid separately)	cu m	per % cu m	% cu ft
5.	Earthfilling in plinth	cu m	per % cu m	% cu ft
6.	Earthwork in banking, cutting, in road and irrigation channel	cu m	per % cu m	% cu ft
7.	Surface dressing and levelling, cleaning, etc.	sq m	per sq m	% sq ft
8.	Cutting of trees (Girth specified)	no.	per no.	per no.
9.	Puddling, Puddle clay core	cu m	per % cu m	% cu ft
10.	Sand filling	cu m	per cu m	% cu ft
11.	Quarrying of stone or boulder	cu m	per cu m	% cu ft
12.	Blasting of rock (Blasted stone stacked and then measured)	cu m	per cu m	% cu ft
<b>Note.</b> — (For earthwork, normal lead is 30 m and normal lift is 1.5 m).				

Sl. No.	Particulars of Items	Units of measurement in MKS	Units of payment in MKS	Units of payment in FPS
<b>Concrete —</b>				
1.	Lime concrete (L.C.) in foundation	cu m	per cu m	% cu ft
2.	Lime concrete (L.C.) in roof terracing, thickness specified (May also be in volume basis as practice in U.P.)	sq m	per sq m	% sq ft
3.	Cement concrete (C.C.)	cu m	per cu m	per cu ft
4.	Reinforced cement concrete (R.C.C.)	cu m	per cu m	per cu ft
5.	C.C. or R.C.C. Chujja, sun shade	cu m	per cu m	per cu ft
6.	Precast C.C. or R.C.C.	cu m	per cu m	per cu ft
7.	Jali work or jalfri work or C.C. tracery panels (Thickness specified)	sq m	per sq m	per sq ft
8.	Cement concrete bed	cu m	per cu m	per cu ft
<b>D.P.C. —</b>				
9.	Damp proof course — Cement concrete, Rich cement mortar, Asphalt, etc. (Thickness specified)	sq m	per sq m	% sq ft
<b>Brickwork —</b>				
1.	Brickwork in foundation and plinth, in superstructure, in arches, etc., in cement, lime or mud mortar	cu m	per cu m	% cu ft
2.	Sun dried brickwork	cu m	per cu m	% cu ft
3.	Honey-comb brickwork, thickness specified... (May also be in volume basis as practice in U.P.)	sq m	per sq m	% sq ft
4.	Brickwork in jack arches, if measured separately	cu m	per cu m	% cu ft
5.	Jack arch roofing including top finishing	sq m	per sq m	% sq ft
6.	Brickwork in well steining	cu m	per cu m	% cu ft
7.	Half-brickwork with or without reinforcement (May also be in cu m as practice in U.P.)	sq m	per sq m	% sq ft
8.	Thin partition wall	sq m	per sq m	% sq ft
9.	Reinforced brickwork (R.B. work)	cu m	per cu m	% cu ft
10.	String course, drip course, weather course, coping etc. (Projection specified)	metre	per m	per r ft



Sl. No.	Particulars of Items	Units of measurement in MKS	Units of payment in MKS	Units of payment in FPS
11.	Cornice (Projection and type specified) ...	metre	per m	per r ft
12.	Brickwork in Fire place, Chulla, Chimney ...	cu m	per cu m	% cu ft
13.	Pargetting Chimney, fire place flue ...	metre	per m	per r ft
14.	Brick edging (by road side) ...	metre	per m	per r ft
<b>Stone work —</b>				
1.	Stone masonry, Random Rubble masonry, Coursed Rubble masonry, Ashlar masonry in walls, in arches, etc. ...	cu m	per cu m	% cu ft
2.	Cut stone work in lintel, beam, etc. ...	cu m	per cu m	per cu ft
3.	Stone slab in roof, shelve, etc., stone chujas, stone sun shed, etc. (Thickness specified) ...	sq m	per sq m	% sq ft
4.	Stone work in wall facing or lining (Thickness specified) ...	sq m	per sq m	per sq ft
<b>Wood work —</b>				
1.	Wood work, door and window frame or chowkhat, rafters beams, roof trusses, etc. ...	cu m	per cu m	per cu ft
2.	Door and window shutters or leaves, panelled, battened, glazed, part panelled and part glazed, wire gauged, etc. (Thickness specified) ...	sq m	per sq m	per sq ft
3.	Door and window fittings as hinges tower bolts, sliding bolts, handles, etc. ... (May also be on the basis of area of shutters as practice in U.P.)	no.	per no.	per no.
4.	Timbering, boarding (Thickness specified) ...	sq m	per sq m	per sq ft
5.	Timbering of trenches (Area of face supported) ...	sq m	per sq m	per sq ft
6.	Sawing of timber ...	sq m	per sq m	per sq ft
7.	Woodwork in partition, Ply wood, etc. ...	sq m	per sq m	per sq ft
8.	Balies (Diameter specified) ...	metre	per m	per r ft
<b>Steel work —</b>				
1.	Rolled Steel joists, Channels, Angles, T-irons, Flats, Squares, Rounds, etc. ...	quintal	per q	per cwt
2.	Steel reinforcement bars, etc., in R.C.C., R. B. work ...	quintal	per q	per cwt
3.	Bending, binding of steel reinforcement ...	quintal	per q	per cwt

Sl. No.	Particulars of Items	Units of measurement in MKS	Units of payment in MKS	Units of payment in FPS
4.	Fabrication and hoisting of steel work ...	quintal	per q	per cwt
5.	Expanded Metal (X.P.M.), size specified ...	sq m	per sq m	per sq ft
6.	Fabric reinforcement, wire netting ...	sq m	per sq m	per sq ft
7.	Iron work in struss ...	quintal	per q	per cwt
8.	Gusset plate (Minimum rectangular size from which cut) ...	quintal	per q	per cwt
9.	Cutting of Iron Joists, channels ...	cm	per cm	per inch
10.	Cutting, Angles, Tees, Plate ...	sq cm	per sq cm	per sq inch
11.	Threading in iron ...	cm	per cm	per inch
12.	Welding, solder of sheets, plates (Welding of rails, steel, trusses, rods— per no.)	cm	per cm	per inch
13.	Boring holes in iron ...	no	per no.	per no.
14.	Cast Iron (C.I.) pipe, Dia. specified ...	metre	per m	per ft
15.	Rivets, Bolts and nuts, Anchor bolts, Lewis bolts, Holding down bolts, etc. ...	quintal	per q	per cwt
16.	Barbed wire fencing ...	metre	per m	% r ft
17.	Iron gate (May also be by weight, quintal)	sq m	per sq m	per sq ft
18.	Iron hold fast (May also be by no.)	quintal	per q	per cwt
19.	Iron railing (Height and types specified) ...	metre	per m	per r ft
20.	Iron grill, collapsible gate (May also be by weight, quintal)	sq m	per sq m	per sq ft
21.	Rolling shutter ...	sq m	per sq m	per sq ft
22.	Steel doors and windows (type and fixing specified) ...	sq m	per sq m	per sq ft
<b>Roofing —</b>				
1.	Tiled roof — Allahabad tile, Faizabad tile, Mangalore tile, etc. including battens ...	sq m	per sq m	% sq ft
2.	Country tile roof including bamboo jaffri ...	sq m	per sq m	% sq ft
3.	Corrugated iron (G.C.I.) roof, Asbestos cement (A.C.) sheet roof ...	sq m	per sq m	% sq ft

Sl. No.	Particulars of Items	Units of measurement in MKS	Units of payment in MKS	Units of payment in FPS
4.	Slate roofing, timber roofing	sq m	per sq m	% sq ft
5.	Thatch roofing including bamboo jaffri (Thickness specified)	sq m	per sq m	% sq ft
6.	Eave board (Thickness specified)	sq m	per sq m	per sq ft
7.	R.C.C., R.B. slab roof (excluding steel)	cu m	per cu m	per cu ft
8.	Lime concrete roof over and inclusive of tiles or brick, or stone slab, etc. (Thickness specified)	sq m	per sq m	% sq ft
9.	Mud roof over and inclusive of tiles, or bricks, or stone slab, etc. (Thickness and type specified)	sq m	per sq m	% sq ft
10.	Ridges, valleys, gutters, (Girth specified)	metre	per m	per r ft
11.	Tar felting, Bituminous painting	sq m	per sq m	% sq ft
12.	Insulating layer in roof of sand and clay, asphalt, etc.	sq m	per sq m	% sq ft
13.	Expansion, contraction or construction joint	metre	per m	per r f
14.	Ceiling—Timber, A.C. Sheet plain, Cloth, Cement plaster on XPM, Paste board, etc.	sq m	per sq m	per sq ft
15.	Centering and shuttering, Form work—Surface area of R.C.C. or R.B. work supported (May also be per cu m (cu ft) of R.C.C. or R.B. work)	sq m	per sq m	% sq ft
<b>Plastering, Pointing and Finishing—</b>				
1.	Plastering—Cement mortar, Lime mortar, mud, etc. (Thickness, proportion specified)	sq m	per sq m	% sq ft
2.	Pointing—Struck, Flush, Weather, etc.	sq m	per sq m	% sq ft
3.	Dado (Thickness and type specified)	sq m	per sq m	% sq ft
4.	Skirting (Thickness type and height specified)	metre	per m	per r ft
5.	Cement mortar or lime mortar rubbing	sq m	per sq m	% sq ft
6.	White washing, Colour washing, Cement washing (No. of coat specified)	sq m	per sq m	% sq ft
7.	Distemping (No. of coat specified)	sq m	per sq m	% sq ft
8.	Snow cement washing or finishing (No. of coat specified)	sq m	per sq m	% sq ft

Sl. No.	Particulars of Items	Units of measurement in MKS	Units of payment in MKS	Units of payment in FPS
9.	Painting, Varnishing (No. of coat specified)	sq m	per sq m	% sq ft
10.	Polishing of wood work (No. of coat specified)	sq m	per sq m	% sq ft
11.	Painting letters and figures (Height specified)	no.	per no.	per no.
12.	Oiling and clearing of doors and windows	sq m	per sq m	% sq ft
13.	Coal tarring (No. of coat specified)	sq m	per sq m	% sq ft
14.	Removing of paint or varnish	sq m	per sq m	% sq ft
15.	Gobri Lepping (cow dung wash)	sq m	per sq m	% sq ft
<b>Flooring—</b>				
1.	2.5 cm (1") C.C. over 7.5 cm (3") L.C. Floor (including L.C.)	sq m	per sq m	% sq ft
2.	Conglomerate floor, artificial patent stone floor 2.5 cm (1") C.C. over 7.5 cm (3") L.C. (including L.C.)	sq m	per sq m	% sq ft
3.	4 cm (1½") thick stone floor flag stone floor over 7.5 cm (3") L.C. (including L.C.)	sq m	per sq m	% sq ft
4.	2.5 cm (1") marble flooring over 7.5 cm (3") L.C. (including L.C.)	sq m	per sq m	per sq ft
5.	Mosaic or terrazo or granolithic floor over 7.5 cm (3") L.C. (including L.C.)	sq m	per sq m	per sq ft
6.	Brick flat floor over 7.5 cm (3") L.C. (including L.C.)	sq m	per sq m	% sq ft
7.	Brick on edge floor over 7.5 cm (3") L.C. (including L.C.)	sq m	per sq m	% sq ft
8.	2.5 cm (1") or 4 cm (1½") C.C., floor	sq m	per sq m	% sq ft
9.	Mud flooring finished gobri lepping	sq m	per sq m	% sq ft
10.	Apron or Plinth protection (May be of C.C., L.C., brick, etc.)	sq m	per sq m	% sq ft
11.	Door and window sill (C.C. or cement mortar plastered)	sq m	per sq m	% sq ft
<b>Miscellaneous Items—</b>				
1.	Ornamental cornice (Projection, type specified)	metre	per m	per r ft
2.	Moulding String course, Drip course, Beading, Throating, etc.	metre	per m	per r ft

Sl. No.	Particulars of Items	Units of measurement in MKS	Units of payment in MKS	Units of payment in FPS
3.	Ornamental Pillar caps, Pillar base, Flowers, Brackets, etc. ...	no.	per no.	per no.
4.	Railing (Height and type specified) ...	metre	per m	per r ft
5.	Surface drain small (size, material, etc. specified) ...	metre	per m	per r ft
6.	Surface drain large (item wise) — (i) Masonry (ii) Plastering ...	cu m sq m	per cu m per sq m	% cu ft % sq ft
7.	Pipe — rainwater, sanitary, water pipe, etc. (Dia. specified) ...	metre	per m	per r ft
8.	Laying pipe line — sanitary, water pipe, etc. (Dia, depth, bedding etc. specified) ...	metre	per m	per r ft
9.	Jungle clearance (May also be per km for road and irrigation channel) ...	sq m or hectare	per sq m or per hectare	% sq ft or per acre
10.	Silt clearance in irrigation channels (Similar to earthwork) (For thin layer upto 5 cm may be on area basis) ...	cu m	per % cu m	% cu ft
11.	Trestle, Crate (size, type, etc. specified) ...	no.	per no.	per no.
12.	Cleaning flues ...	no.	per no.	per no.
13.	Cotton cords in sk; light (May also be by weight in kg) ...	no.	per no.	per no.
14.	Easing doors and windows ...	no.	per no.	per no.
15.	Fixing doors and windows ...	no.	per no.	per no.
16.	Supply and fixing of Hinges, Tower bolts, Hasp and staples, Handles, Hardwares, etc. ...	no.	per no.	per no.
17.	Glazing ...	sq m	per sq m	per sq ft.
18.	Glass panes (supply) ...	sq m	per sq m	per sq ft.
19.	Fixing of glass panes or cleaning ...	no.	per no.	per no.
20.	Renewing of glass panes ...	no.	per no.	per no.
21.	Well sinking (Masonry or tube well) ...	metre	per m	per r ft.
22.	Pile driving or sinking ...	metre	per m	per r ft
23.	Furnitures — Chairs, tables, etc. (size shape specified) ...	no.	per no.	per no.

Sl. No.	Particulars of Items	Units of measurement in MKS	Units of payment in MKS	Units of payment in FPS
24.	Painting furnitures ...	no.	per no.	per no
25.	Caning chairs ...	no.	per no.	per no.
26.	Pitching of brick, stone, kankar, etc. (Brick pitching may also be on area basis in sq m) ...	cu m	per cu m	% cu ft
27.	Lining of Irrigation Channel, Tunnel, etc. Materials, thickness specified (Thick lining may be in volume basis in cu m) ...	sq m	per sq m	% sq ft
28.	Kankar quarrying, kankar supply ...	cu m	per cu m	% cu ft
29.	Kankar consolidation, road metal consolidation ...	cu m	per cu m	% cu ft
30.	Dug-belling (May also be per km) ...	metre	per m	% r ft
31.	Bituminous road surfacing ...	sq m	per sq m	% sq ft
32.	Dismantling —	Same as for different items	Same as for different items	Same as for different items
33.	Dismantling of brick masonry ...	cu m	per cu m	% cu ft
34.	Grouting (Bituminous grouting of road metal, cement grouting of concrete) ...	sq m	per sq m	% sq ft
35.	Grouting of cracks, joints, etc. ...	metre	per m	per r ft
36.	Electric Wiring or Electrification Light, Fan, Plug points ...	point	per point	per point
37.	Watercloset (W.C.), Wash hand basin, Man-hole, etc. (size specified) ...	no	per no	per no
<b>Materials —</b>				
1.	Supply of bricks ...	% nos.	per % nos.	% nos.
2.	Supply of Sand, Surkhi, Cinder, etc. ...	cu m	per cu m	% cu ft
3.	Supply of cement ...	bag of 50 kg	per bag or per quintal or per tonne	per cwt or per ton
4.	Supply of lime unslaked ...	quintal	per quintal	per maund
5.	Supply of lime slaked (May also be in volume basis in cu m) ...	quintal	per quintal	per maund

Sl. No.	Particulars of Items	Units of measurement in MKS	Units of payment in MKS	Units of payment in FPS
6.	Supply of Brick ballast, Stone ballast, Aggregate, etc.	cu m	per cu m	% cu ft
7.	Broken bricks, Kankar, etc.	cu m	per cu m	% cu ft
8.	Supply of Timber	cu m	per cu m	% cu ft
9.	Supply of Steel	quintal	per q or per tonne	per cwt
10.	Supply of Bitumen, Tar	tonne	per tonne	per ton
11.	Supply of Coal	tonne	per tonne	per ton
12.	Supply of A.C. sheets (Measured flat)	sq m	sq m	sq ft
13.	Supply of G.I. sheet	quintal	per quintal	per cwt
14.	Supply of switches, plugs, ceiling roses, bulbs, brackets, etc.	no.	per no.	per no.
15.	Supply of insulated electric wire (size specified)	quintal	per quintal	per cwt
16.	Supply of bare electric wire (size specified)	quintal	per quintal	per cwt
17.	Tents, sholdaries (size specified)	no.	per no.	per no.
18.	Supply of Water closet, W.C. (size specified)	no.	per no.	per no.
19.	Supply of Wash hand basin (size specified)	no.	per no.	per no.
20.	Supply of Cowl, Mica valve, Intercepting trap, etc. (size specified)	no.	per no.	per no.
21.	Supply of Bib cock, Stop cock, Ball cock, etc. (size specified)	no.	per no.	per no.
22.	Supply of Ferrule, C.I. Tank, Water meter, etc. (size specified)	no.	per no.	per no.
23.	Supply of pipe, C.I. pipe, S. W. pipe, Hume pipe, A.C. pipe, G.I. pipe, etc. (Dia. specified)	metre	per m	per r ft
24.	Supply of lead, lead wool	kg or quintal	per kg or per quintal	per cwt
25.	Spun yarn	kg	per kg	per lb
26.	Supply of varnish, oil, etc.	litre	per litre	per gl

Sl. No.	Particulars of Items	Units of measurement in MKS	Units of payment in MKS	Units of payment in FPS
27.	Supply of paint ready mix	litre	per litre	per gl
28.	Supply of stiff paint	kg	per kg	per lb
29.	Explosive for blasting	kg	per kg	per lb

Note : (i) Particulars of items should be fully described.  
(ii) For further items of work P.W.D. Schedule of Rates may be consulted. (See Chapter 20).  
(iii) For Rules and Methods of Measurement. (See Chapter 14).

#### SIZES AND DIMENSIONS OF VARIOUS WORKS IN MKS AND THE CORRESPONDING FPS UNITS, APPROXIMATE

- Sizes of Doors —

120 cm × 210 cm (1.20 m × 2.10 m)	} — 4' - 0" × 6' - 6 1/4"
110 cm × 200 cm (1.10 m × 2.00 m)	
100 cm × 190 cm (1.00 m × 1.90 m)	} — 3' - 3" × 6' - 3"
90 cm × 180 cm (0.90 m × 1.80 m)	
75 cm × 180 cm (0.75 m × 1.80 m)	} — 2' - 6" × 6' - 0"
- Size of Windows —

100 cm × 150 cm (1.00 m × 1.50 m)	} — 3' - 3" × 5' - 0"
90 cm × 120 cm (0.90 m × 1.20 m)	
	} — 3' × 4'
- Size of C.S. Windows, Ventilators —

120 cm × 60 cm (1.20 m × 0.60 m)	} — 4' × 2'
100 cm × 60 cm (1.00 m × 0.60 m)	
90 cm × 50 cm (0.90 m × 0.50 m)	} — 3' - 0" × 1' - 6"
- Size of Chowkhat sections for Doors and Windows —

12 cm × 7.5 cm — 5" × 3"	
10 cm × 10 cm — 4" × 4"	
10 cm × 7.5 cm — 4" × 3"	
7.5 cm × 7.5 cm — 3" × 3"	
- Thickness of Doors and Windows, Shutter or Leaves

2.5 cm — 1"	3 cm — 1 1/4"
4 cm — 1 1/2"	4.5 cm — 1 3/4"
- Thickness of Lime Concrete in Foundation —

15 cm — 6"	20 cm — 8"
25 cm — 10"	30 cm — 12"
40 cm — 16"	45 cm — 18"
- Thickness of Lime Concrete in Roof Terracing —

7.5 cm — 3"	
10 cm — 4"	
12 cm — 4 1/2"	
- Thickness of R.C.C. Slab —

7.5 cm — 3"	10 cm — 4"
12.5 cm — 5"	15 cm — 6"
- Thickness of Plastering —

10 mm — 3/8"	12 mm — 1/2"
15 mm — 1/2"	20 mm — 3/4"
- Thickness of D.P.C. —

2 cm — 3/4"	
2.5 cm — 1"	
4 cm — 1 1/2"	

- 11. Thickness of C.C. Floor —
  - 2 cm — ¾"
  - 2.5 cm — 1"
  - 4 cm — 1½"
  - 2.5 cm C.C. floor } — 1" C.C. floor
  - over 7.5 cm L.C. } over 3" L.C.
- 12. Insulation layer in Roof —
  - 2.5 cm — 1"
  - 4 cm — 1½"
- 13. Steps, Rise and Tread —
  - 15 cm × 30 cm — 6" × 12"
  - 15 cm × 28 cm — 6" × 11"
  - 18 cm × 28 cm — 7" × 11"

- 14. Height of Plinth —
  - 30 cm — 1' - 0"
  - 45 cm — 1' - 6"
  - 60 cm — 2' - 0"
  - 75 cm — 2' - 6"
- 15. Height of Building —
  - 2.80 m — 9' - 3"
  - 3.00 m — 10' - 0"
  - 3.30 m — 11' - 0"
  - 3.60 m — 12' - 0"
  - 3.90 m — 13' - 0"
  - 4.20 m — 14' - 0"
- 16. Size of Rooms —
  - 3 m × 3 m — 10' × 10'
  - 3.00 m × 3.60 m — 10' × 12'
  - 3.60 m × 3.60 m — 12' × 12'
  - 3.60 m × 4.20 m — 12' × 14'
  - 3.60 m × 4.80 m — 12' × 16'

Mild steels bars, metric dimensions and weights —

Dia. of bars fps. units currently used	¼"	⅜"	½"	⅝"	¾"	⅞"	1"	1¼"	1½"
Dia. and weight in metric unit to be used-Dia.	6 mm	10 mm	12 mm	16 mm	20 mm	22 mm	25 mm	32 mm	40 mm
Wt. per metre	0.22 kg	0.62 kg	0.89 kg	1.58 kg	2.47 kg	2.98 kg	3.85 kg	6.31 kg	9.86 kg

STANDARD MODULAR BRICKS

Size of standard modular bricks —

Sizes of standard modular bricks as fixed by Indian Standard Institution are as given below (Fig. 1-9). These standard bricks will now be manufactured and used and old traditional bricks shall be given up.

(Standard Modular Bricks with Frogs, all Dimensions in Centimetres (Fig. 1-9))

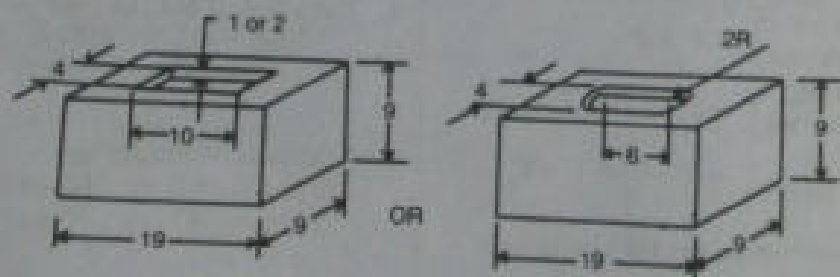

Fig. 1-9

	Actual size	Nominal size
Standard modular brick	19 cm × 9 cm × 9 cm	20 cm × 10 cm × 10 cm
Standard modular brick-tile	19 cm × 9 cm × 4 cm	20 cm × 10 cm × 5 cm

Thickness of wall with standard brick —

Wall	½ brick	1 brick	1½ brick	2 brick	2½ brick	3 brick
Thickness of Wall	10 cm	20 cm	30 cm	40 cm	50 cm	60 cm

Actual thickness of wall with 1 cm mortar joint are 9 cm for ½ brick, 19 cm for 1 brick, 29 cm for 1½ brick, 39 cm for 2 brick, 49 cm for 2½ brick, 59 cm for 3 brick. But the thickness of wall is taken as multiple of 10 as given in the above table irrespective of the actual thickness for estimating and for payment. Above 3 brick wall the thickness of wall is actually measured after construction for payment but for estimating the thickness may be taken as multiple of 10.

Thickness of R.B. lintel and slab with standard brick —

Layer	1 flat brick	2 flat brick	3 flat brick	4 flat brick
Thickness	10 cm	20 cm	30 cm	40 cm

Using brick-tile in combination with brick the thickness of R.B. lintel and slab may also be made as 15 cm, 25 cm, 35 cm, etc.

TRADITIONAL BRICKS

Metric dimensions of present traditional (9" × 4½" × 3") bricks and width of walls —

As the standard modular bricks are not being manufactured, the metric dimensions of present bricks of 9" × 4½" × 3" (nominal size) have been fixed to the nearest one place of decimal. Until the metric standard bricks are available, the present traditional bricks are to be used and the thickness of walls shall be measured as multiple of half brick (11.4 cm). The dimensions of traditional brick and thickness of walls in metric unit are as given below —

Dimensions of traditional brick in metric unit —

	Actual	Metric Dimension
Actual	9" × 4½" × 2½"	22.9 cm × 11.2 cm × 7.0 cm
Nominal	9" × 4½" × 3"	22.9 cm × 11.4 cm × 7.6 cm

Width of walls present traditional bricks in metric unit —

Walls —	½ brick	1 brick	1½ brick	2 brick	2½ brick	3 brick	3½ brick	4 brick
Thickness of walls —	7.6 cm	11.4 cm	22.9 cm	34.3 cm	45.7 cm	57.1 cm	68.6 cm	80.0 cm

For 10" × 5" × 3" size (nominal) brick, the metric dimension will be taken as 25.4 cm × 12.7 cm × 7.6 cm (nominal) and the thickness of walls shall be measured as multiple of half brick (12.7 cm), and shall be as 7.6 cm, 12.7 cm, 25.4 cm, 37.1 cm, 50.8 cm, 63.5 cm, 76.2 cm, 88.9 cm, 101.6 cm, 114.3 cm and so on.

METHOD OF BUILDING ESTIMATE

**Example 1.** — Estimate the quantities of brickwork and plastering required in a wall 4 m long, 3 m high and 30 cm thick. Calculate also the cost if the rate of brickwork is Rs. 320.00 per cu m and of plastering is Rs. 8.50 per sq m.

Quantity of brickwork =  $L \times B \times H = 4 \text{ m} \times 3 \text{ m} \times .30 = 3.6 \text{ cu m}$ .  
 Quantity of plastering (two faces) =  $2 \times L \times H = 2 \times 4 \text{ m} \times 3 \text{ m} = 24 \text{ sq m}$ .  
 Cost of brickwork =  $3.6 \times 320.00 = \text{Rs. } 1152.00$ .  
 Cost of plastering =  $24 \times 8.50 = \text{Rs. } 204.00$ .  
 Total cost =  $1152.00 + \text{Rs. } 204.00 = \text{Rs. } 1356.00$ .

**Example 2.** — Prepare a detailed estimate of part of a wall of a building from the given plan and section and general specifications (Figs. 2-1 and 2-2).

GENERAL SPECIFICATIONS :

- (1) Foundation concrete shall be of lime concrete.
- (2) Foundation and plinth shall be of 1st class brickwork in lime mortar.
- (3) Damp Proof Course — 2.5 mm c.c. 1 : 1½ : 3 with water proofing compound.
- (4) Superstructure — 1st class brickwork in lime mortar.
- (5) Wall finishing — Inside wall 12 mm Cement plastered 1 : 6 and white washed 3 coats.

Outside wall 12 mm cement plastered 1 : 6 including 10 cm below ground level and finished with two coats of colour wash over one coat of white washing.

RATES : Assume local current rates.

*Note: — Fig. 2-1 and Fig. 2-2 are plan and cross-section of the wall with standard modular brick and with traditional brick respectively. For simplicity only a portion of a wall has been taken and hence there are no footings at the ends.*

Plan and Section

Fig. 2-1

WALL WITH STANDARD MODULAR BRICKS.

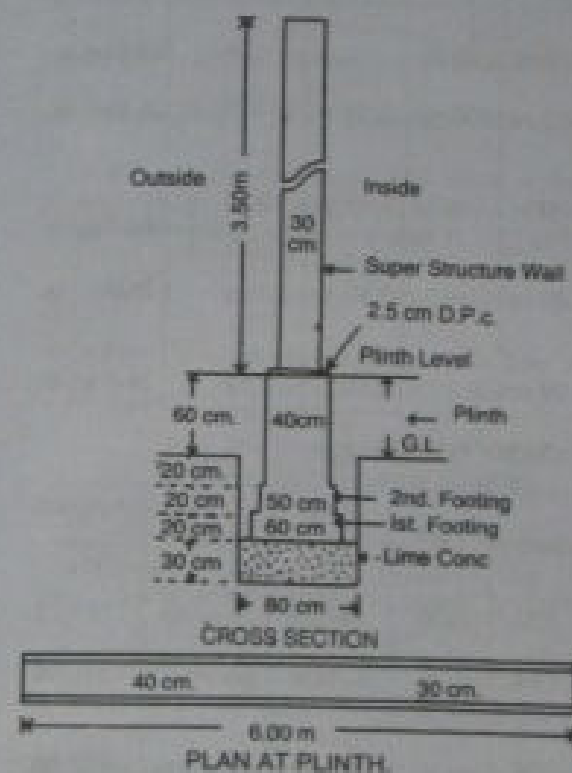
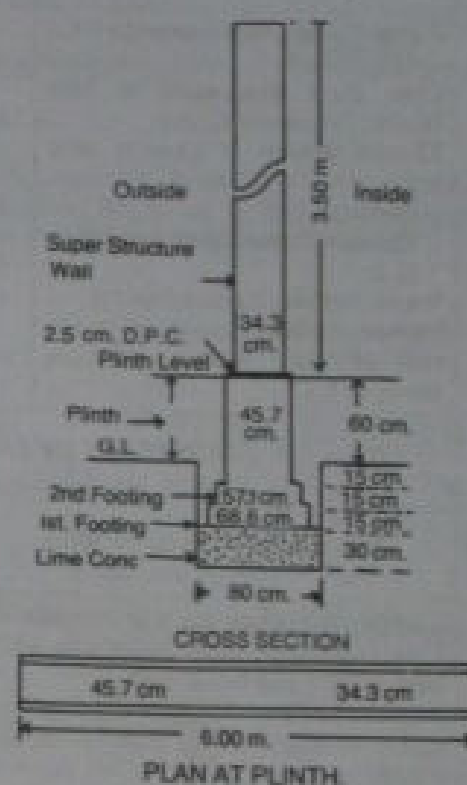

Fig. 2-2

WALL WITH TRADITIONAL BRICKS.



With Standard Bricks, Fig. 2-1 —

DETAILS OF MEASUREMENT AND CALCULATION OF QUANTITIES (Ex. 2)

Item No.	Description of items of work	No.	Dimensions			Quantities or Contents	Total quantities
			Length	Breadth	Ht. or Depth		
1.	Earthwork in excavation in foundation	1	6.00 m	.80 m	.90 m	4.32	4.32 cu m
2.	Lime concrete in foundation	1	6.00 m	.80 m	.30 m	1.44	1.44 cu m
3.	1st class brickwork in lime mortar in foundation and plinth						
	1st footing	1	6.00 m	.60 m	.20 m	.72	3.24 cu m
	2nd footing	1	6.00 m	.50 m	.20 m	.60	
	Plinth wall up to G.L.	1	6.00 m	.40 m	.20 m	.48	
	Plinth wall above G.L.	1	6.00 m	.40 m	.60 m	1.44	

(Cont. L.)

Item No.	Description of items of work	No.	Dimensions			Quantities or Contents	Total quantities
			Length	Breadth	Ht. or Depth		
4.	2.5 cm Damp proof course (D.P.C.) e.c. 1 : 1½ : 3	1	6.00 m	.40 m	—	2.4	2.4 sq. m
5.	First class Brickwork in lime mortar for superstructure	1	6.00 m	.30 m	3.50 m	6.3	6.3 cu m
6.	12 mm plaster of Cement sand 1:6—						
	Inside	1	6.00 m	—	3.50 m	21.0	46.2 sq m
	Outside including 10 cm below G.L.	1	6.00 m	—	4.20 m	25.2	
7.	White washing 3 coats (inside)	1	6.00 m	—	3.50 m	21.0	21.0 sq m
8.	Colour washing 2 coats over one coat of white washing (outside above G.L.)	1	6.00 m	—	4.10 m	24.6	24.6 sq m

## ABSTRACT OF ESTIMATED COST (Ex. 2)

Item No.	Description of Items of Work	Quantity	Unit	Rate	Per	Amount
				Rs.		Rs.
1.	Earthwork in excavation in Foundation	4.32	cu m	350.00	% cu m	15.12
2.	Lime concrete in foundation with white lime, surkhi and brick ballast	1.44	cu m	220.00	per cu m	316.80
3.	1st class brickwork with white lime and surkhi mortar 1 : 2 in foundation and plinth	3.24	cu m	300.00	per cu m	972.00
4.	2.5 cm thick e.c. 1 : 1½ : 3 Damp proof course with water proofing compound	2.4	sq m	20.00	per sq m	48.00
5.	1st class Brickwork with white lime and surkhi 1 : 2 mortar in super-structure	6.3	cu m	320.00	per cu m	2016.00
6.	12 mm cement and local sand plaster 1 : 6	46.2	sq m	8.50	per sq m	392.70
7.	White washing 3 coats	21.0	sq m	0.75	per sq m	15.75
8.	Colour washing 2 coats over one coat of white washing	24.6	sq m	0.82	per sq m	20.17
				Total	...	3796.54
	Add for Contingencies 3%				...	113.90
	Add for Workcharged Establishment 2%				...	75.93
				Grand Total	...	3986.37

Note : — For the items of plastering and white washing or colour washing the end faces of the wall have not been taken into consideration; and the outer plinth offset of 5 cm has been neglected.

**Trench Filling.** — Earthwork in trench filling is usually not taken into account. If required this can be calculated as follows :—

Quantity of earthwork in trench filling = Quantity in excavation — Quantity of concrete + Quantity of brickwork upto G.L. = 4.32 — (1.44 + 1.80) = 1.08 cu m.

For simplicity the earthwork in trench filling may be taken as 1/5 of earthwork in excavation.

**Example 2 — With Traditional Bricks, Fig. 2.2 —**

With traditional bricks, the items of foundation concrete, Plastering, White washing and Colour washing are same as for above. The earthwork, Brickwork in foundation and plinth, Brickwork in superstructure, and D.P.C. differ and are as calculated below :—

Item 1. — Earthwork in excavation in foundation	1 × 6.00 m × .80 m × .75 m = 3.60 cu m
Item 3. — 1st class brickwork in lime mortar in foundation and plinth —	
1st footing	1 × 6.00 m × .686 m × .15 m = 0.62 cu m
2nd footing	1 × 6.00 m × .571 m × .15 m = 0.52
Plinth wall above footing	1 × 6.00 m × .457 m × .75 m = 2.06
	Total = 3.20 cu m

Item 4. — 2.5 cm thick D.P.C. 1 : 1½ : 3 ... 1 × 6.00 m × .457 m = 2.74 sq m

Item 5. — First class brickwork in lime mortar in superstructure ... 1 × 6.00 m × .343 m × 3.5 m = 7.20 cu m

Abstract of cost may be prepared accordingly.

## METHODS OF BUILDING ESTIMATE

The dimensions, length, breadth and height or depth are to be taken out from the drawing — plan, elevation and section. From the study of the drawings, the building is to be imagined and pictured in the mind and the dimensions are to be taken out correctly. There is no hard and fast rule for finding out dimensions from the drawing but the dimensions are to be taken out accurately. Junctions of wall at the corners and at the meeting points of walls require special attention.

For symmetrical foundation which is the usual case, earthwork in excavation in foundation, foundation concrete, brick work in foundation and plinth, and brickwork in superstructure may be estimated by either of the following two methods.

## METHOD I

**Separate or individual wall method.** — In this method, measure or find out the external length of walls running in the longitudinal direction generally the long walls out-to-out, and the internal lengths of walls running in the transverse direction in-to-in i.e. of cross or short walls in-to-in, and calculate quantities multiplying the length by the breadth and the height of wall. The same rule applies to the excavation in foundation, to concrete in foundation and to masonry. Care should be taken to note the difference in dimensions at different height due to offset, or footings. It is convenient to imagine plans at different level of heights as foundation trench plan, foundation concrete plans of each footing, etc. and dealing each plan or part separately.

The simple method is to take the long walls and short or cross walls separately and to find out the centre to centre lengths of long walls and short walls from the plan. For symmetrical footing on either sides, the centre line remains same for superstructure and for foundation and plinth.

For long walls add to the centre length one breadth of wall, which gives the length of the wall out-to-out, multiply this length by the breadth and the height and get the quantities. Thus for finding the quantities of earthwork in excavation, for length of the trench out-to-out add to the centre length one breadth of foundation. Adopt the same process for foundation concrete, and for each footing. It should be noted that each footing is to be taken separately and the breadth of the particular footing is to be added to the centre length.

(Long wall length out-to-out = centre to centre length + half breadth on one side + half breadth on the other side = centre to centre length + one breadth).

For short or cross walls subtract (instead of adding) from the centre length one breadth of wall, which gives the length in-to-in, and repeat the same process as for the long walls, subtracting one breadth instead of adding.

(Short wall length in-to-in = centre to centre length — one breadth).

That is, in case of long wall add one breadth and in case of short wall subtract one breadth from the centre length to get the corresponding lengths.

In foundation the offset of concrete on either side may be 10 cm to 20 cm depending on the thickness of concrete (usually less than the thickness of concrete). The offset on either side of brick wall of standard bricks is 5 cm, and of traditional bricks is 5.7 cm.

This method can also be worked out in a quicker way. For long walls find the length of the foundation trench of the long wall out-to-out in the same manner as explained above, the length of the foundation concrete is the same, for the length of the first footing or first step of brick wall subtract two offsets in foundation concrete from the length of the trench or concrete, for the second footing subtract from the length of 1st footing two offsets in footing i.e.  $2 \times 5 = 10$  cm ( $2 \times 5.7 = 11.4$  cm for traditional bricks), for the third footing subtract from the length of the 2nd footing two offsets i.e. 10 cm (11.4 cm for traditional bricks) in this way deal the long walls up to the superstructure. [For  $25.4$  cm  $\times$   $12.7$  cm  $\times$   $7.6$  cm ( $10'' \times 5'' \times 3\frac{1}{2}''$ ) bricks, one offset in footing = 6.35 cm and two offsets = 12.7 cm].

For short wall follow the same method but instead of subtracting, add two offsets to get the corresponding length in-to-in.

It will be noticed that by taking dimensions in this way, the long walls are gradually decreasing in length from foundation to superstructure, while the short walls are increasing in length.

It may also be noted that the wall which is taken first is to be treated as long wall though its length may be lesser, and the other wall be treated as short wall.

This method is simple and accurate and there is no chance of any mistake. This method may be named as Long wall and short wall method, or general method.

The following examples (Exs. 3a, 4a, and 5a) illustrate this method :—

Example 3a. — Fig. 2-3, the plan represents the plan of superstructure wall of a single room building of 5 m  $\times$  4 m, and Sections represent the cross-sections of the walls with foundation. Estimate the quantities of —

- (1) Earthwork in excavation in foundation, (2) Concrete in foundation, (3) Brickwork in foundation and plinth and (4) Brickwork in superstructure.

The length of long wall centre to centre =  $5.00 + \frac{1}{2} \times .30 + \frac{1}{2} \times .30 = 5.30$  m. The length of short wall centre to centre =  $4.00 + \frac{1}{2} \times .30 + \frac{1}{2} \times .30 = 4.30$  m.

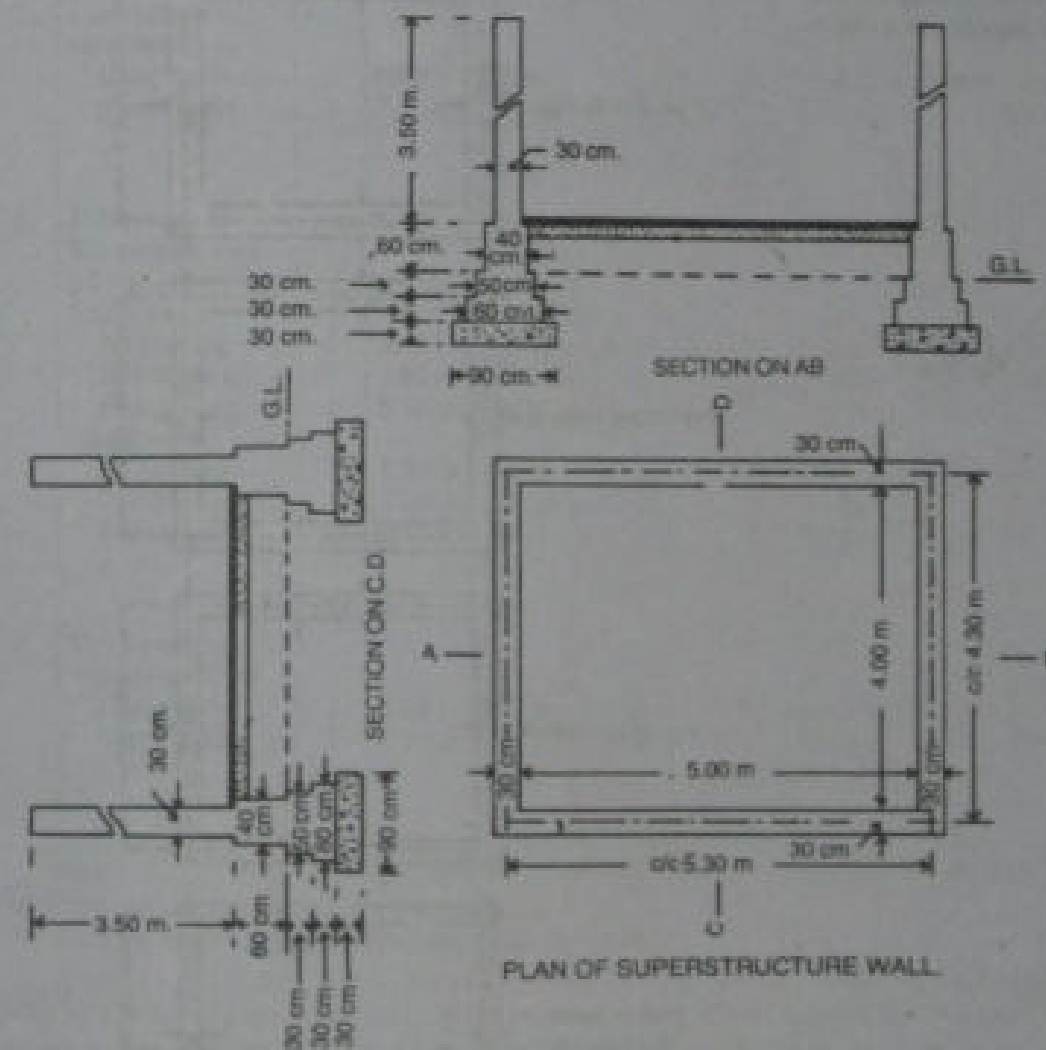

Fig. 2-3



## PLANS AT DIFFERENT LEVELS

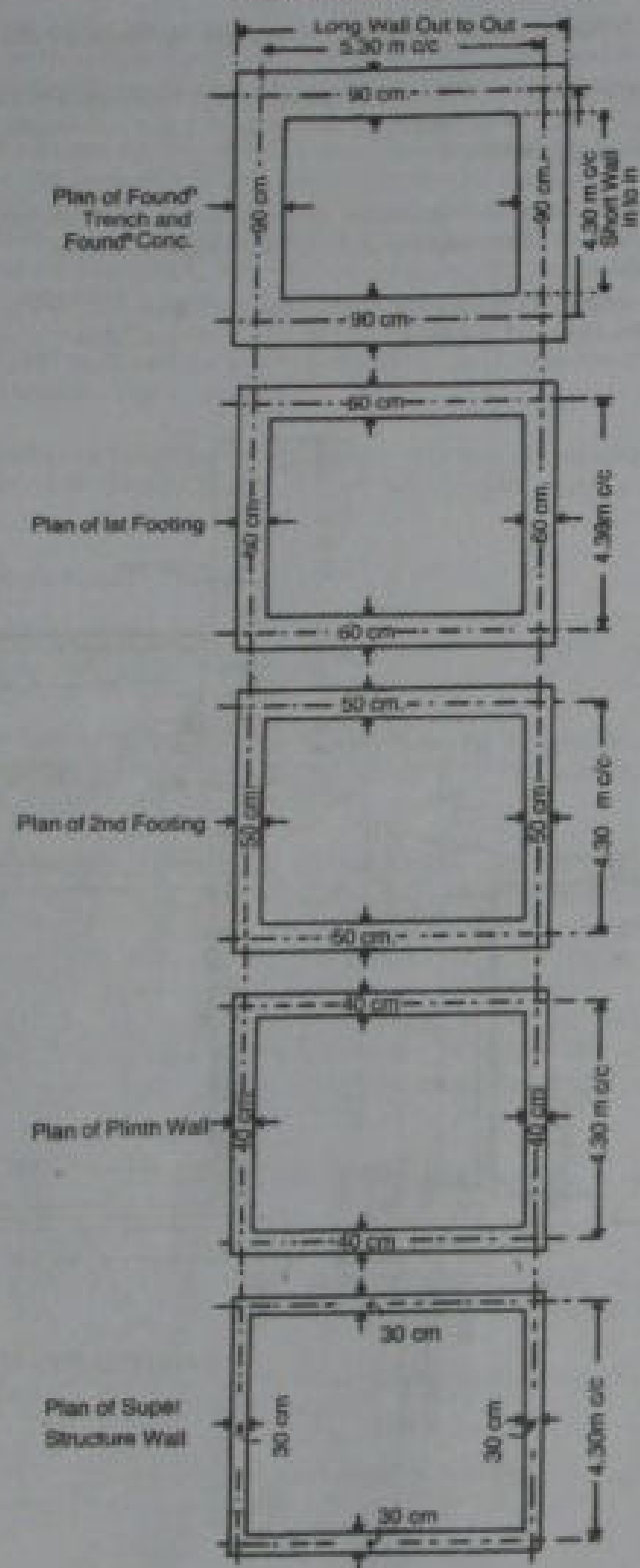

Fig. 2-4

To estimate the quantities, the plan of foundation trench and foundation concrete, the plan of each footings or steps of wall may be imagined as given in Fig. 2-4. Then the long wall in-to-in and the short wall in-to-in of each part may be dealt one by one.

## DETAILS OF MEASUREMENT AND CALCULATION OF QUANTITIES (Ex. 3a)

Item No.	Particulars of Items	No.	Length	Breadth	Height or Depth	Quantity	Explanatory note			
1.	Earthwork in excavation in foundation — Long walls ... Short walls ...	2	6.20 m	.90 m	.90 m	10.04	Length = 5.30 + .90 = 6.20 m Breadth = 4.30 - .90 = 3.40 m			
		2	3.40 m	.90 m	.90 m	5.51				
						Total		15.55 cu m		
2.	Concrete in foundation — Long walls ... Short walls ...	2	6.20 m	.90 m	.30 m	3.35	Length same as for excavation Quantity = $\frac{1}{2}$ of excavation			
		2	3.40 m	.90 m	.30 m	1.83				
						Total		5.18 cu m		
3.	Brickwork in foundation and plinth — Long walls — 1st footing ... 2nd footing ... Plinth walls ... Short walls — 1st footing ... 2nd footing ... Plinth walls ...	2	5.90 m	.60 m	.30 m	2.13	Length = 5.30 + .60 = 5.90 m Length = 5.30 + .50 = 5.80 m Length = 5.30 + .40 = 5.70 m Length = 4.30 - .60 = 3.70 m Length = 4.30 - .50 = 3.80 m Length = 4.30 - .40 = 3.90 m			
		2	5.80 m	.50 m	.30 m	1.74				
		2	5.70 m	.40 m	.60 m	2.74				
		2	3.70 m	.60 m	.30 m	1.33				
		2	3.80 m	.50 m	.30 m	1.14				
		2	3.90 m	.40 m	.60 m	1.87				
						Total		10.95 cu m		
		4.	Brickwork in superstructure Long walls ... Short walls ...	2	5.60 m	.30 m		3.50 m	11.76	Length = 5.30 + .30 = 5.60 m Length = 4.30 - .30 = 4.00 m
				2	4.00 m	.30 m		3.50 m	8.40	
						Total	20.16 cu m			

Note : The door openings, window openings, lintels, etc. shall have to be deducted from superstructure as usual.

See next page (page 34) for further classification.

It may be noted that in the case of long wall, the lengths of the 2nd footing, 3rd footing etc. differ by 10 cm and each is shorter than the previous one by 10 cm. Similarly for short wall the length is longer than the previous footing by 10 cm. Thus the lengths can be obtained by subtracting or adding 10 cm as the case may be. For traditional bricks (22.9 cm × 11.2 cm × 7.6 cm) the length can be obtained by subtracting or adding 11.2 cm. (For 25.4 cm × 12.7 cm × 7.6 cm bricks add or subtract 12.7 cm).

As study of the plans and elevations (Fig. 2-5) will make it clear. The plan (i) shows the foundation footings. The long walls and short walls may be imagined to be constructed separately, first the long walls and then the short walls. From the elevation (ii) and (v) it will be clear that the length of each successive footing of long walls is reduced in length and that of the short walls each successive footing is increased in length.

The corresponding breadth and height can be obtained from the cross-section of wall.

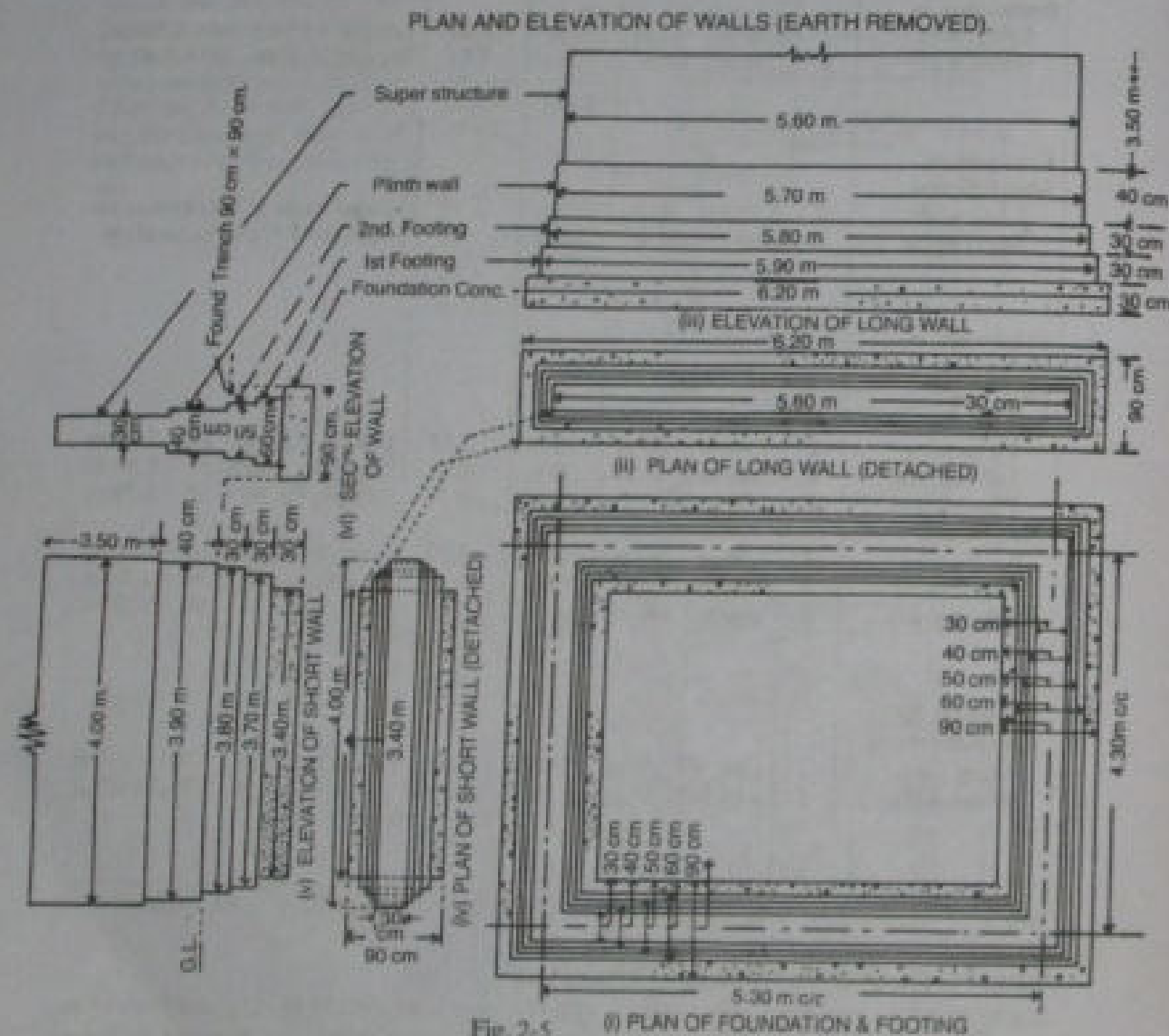
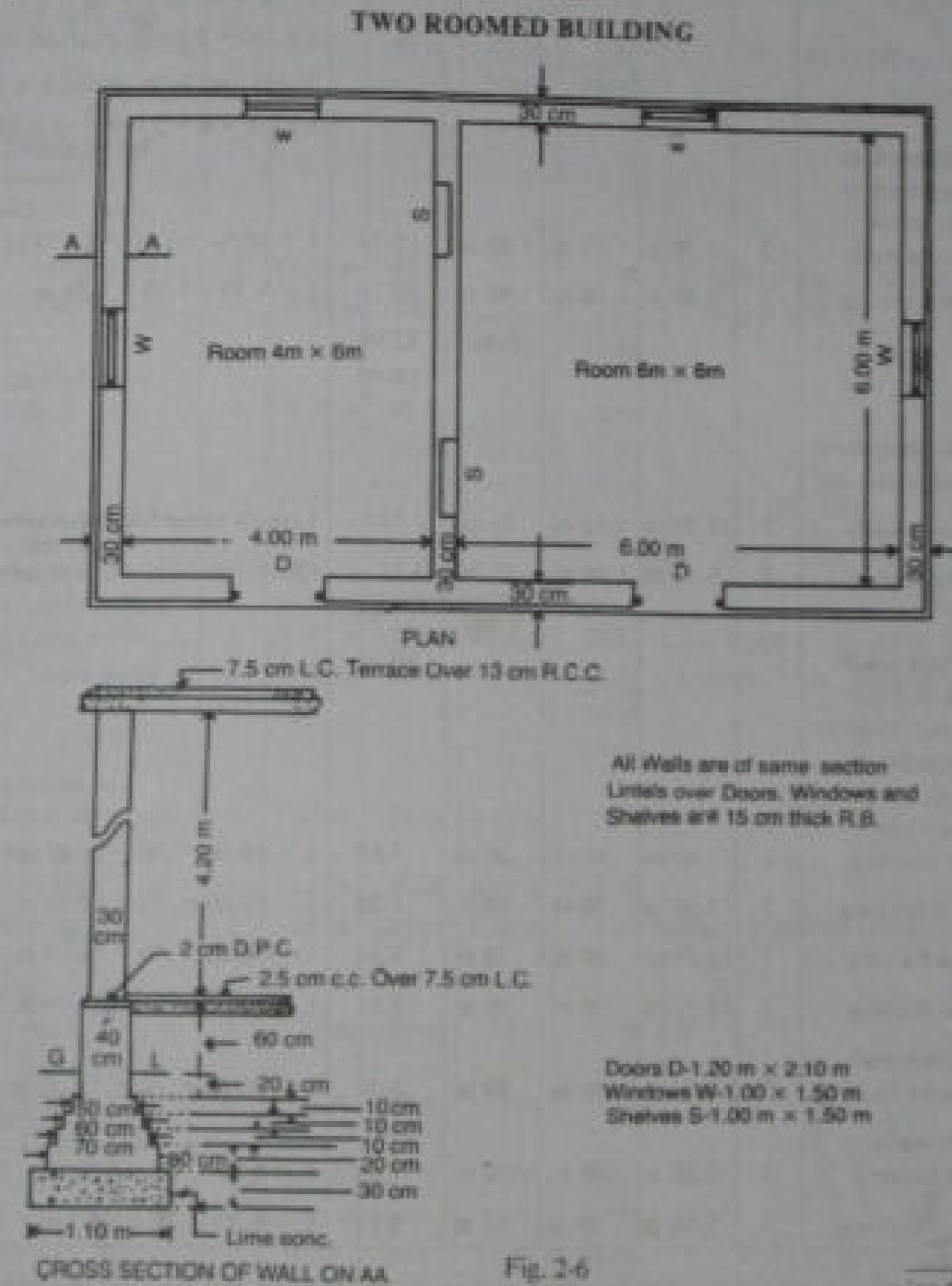

Fig. 2-5 (i) PLAN OF FOUNDATION & FOOTING

In the Example 3(a) with traditional bricks, the breadth of wall in first footing, second footing, plinth wall and superstructure wall will be 68.6 cm, 57.1 cm, 45.7 cm and 34.3 cm respectively. The students may solve this problem having walls with traditional bricks.

Example 4(a). — Estimate the quantities of the following items of a two roomed building from the given plan and section (Fig. 2-6) —

- (1) Earthwork in excavation in foundation,
- (2) Lime concrete in foundation,
- (3) 1st class brickwork in cement mortar 1 : 6 in foundation and plinth,
- (4) 2.5 cm c.c. damp proof course, and
- (5) 1st class brickwork in lime mortar in superstructure.



CROSS SECTION OF WALL ON AA

Fig. 2-6

All Walls are of same section  
Lintels over Doors, Windows and  
Shelves are 15 cm thick R.B.

Doors D-1.20 m x 2.10 m  
Windows W-1.00 x 1.50 m  
Shelves S-1.00 m x 1.50 m

Note : — No beam has been shown in the plan as the object of this example is method of estimating the walls only.

ained simply

## DETAILS OF MEASUREMENT AND CALCULATION OF QUANTITIES (Ex. 4a)

Item No.	Particulars of Items	No.	Length	Breadth	Height or Depth	Quantity	Explanatory note
1.	Earthwork in excavation in foundation —						Long wall, c/c. length = $4 + 6 + .30 + 2 \times \frac{.30}{2} = 10.60$ m Short and Inter walls, c/c. length = $6 + 2 \times \frac{.30}{2} = 6.30$ m
	Long walls ...	2	11.70 m	1.10 m	1.00 m	25.74	$L = 10.60 + 1.10 = 11.70$ m
	Short walls ...	3	5.20 m	1.10 m	1.00 m	17.16	$L = 6.30 - 1.10 = 5.20$ m
					Total	42.90 cu m	
2.	Lime concrete in foundation —						Length same for excavation Quantity = 3/10 of excavation
	Long walls ...	2	11.70 m	1.10 m	.30 m	7.72	
	Short walls ...	3	5.20 m	1.10 m	.30 m	5.15	
					Total	12.87 cu m	
3.	1st class brick-work in 1 : 6 cement mortar in foundation and plinth —						
	Long walls —						
	1st footing ...	2	11.40 m	.80 m	.20 m	3.65	$L = 10.60 + .80 = 11.40$ m
	2nd footing ...	2	11.30 m	.70 m	.10 m	1.58	$L = 10.60 + .70 = 11.30$ m
	3rd footing ...	2	11.20 m	.60 m	.10 m	1.34	$L = 10.60 + .60 = 11.20$ m
	4th footing ...	2	11.10 m	.50 m	.10 m	1.11	$L = 10.60 + .50 = 11.10$ m
	Plinth wall above footing	2	11.00 m	.40 m	.80 m	7.04	$L = 10.60 + .40 = 11.00$ m
	Short walls —						
	1st footing ...	3	5.50 m	.80 m	.20 m	2.64	$L = 6.30 - .80 = 5.50$ m
	2nd footing ...	3	5.60 m	.70 m	.10 m	1.18	$L = 6.30 - .70 = 5.60$ m

Note : — Length of subsequent footings of long walls after 1st footing may be obtained simply by deducting 10 cm from first footing.

(Ex 4a Contd.)

Item No.	Particulars of Items	No.	Length	Breadth	Height or Depth	Quantity	Explanatory note
	3rd footing ...	3	5.70 m	.60 m	.10 m	1.03	$L = 6.30 - .60 = 5.70$ m
	4th footing ...	3	5.80 m	.50 m	.10 m	0.87	$L = 6.30 - .50 = 5.80$ m
	Plinth wall above footing	3	5.90 m	.40 m	.80 m	5.66	$L = 6.30 - .40 = 5.90$ m
					Total	26.10 cu m	
4.	Damp proof course 2.5 cm thick c.c. —						
	Long walls ...	2	11.00 m	.40 m	—	8.80	Lengths same as for plinth wall in item 3.
	Short walls ...	3	5.90 m	.40 m	—	7.08	
					Total	15.88	
	Deduct door sills	2	1.20 m	.40 m	—	0.96	
				Net	Total	14.92 sq m	
5.	1st class brick-work in lime mortar in superstructure						
	Long walls ...	2	10.90 m	.30 m	4.20 m	27.47	$L = 10.60 + .30 = 10.90$ m
	Short walls ...	3	6.00 m	.30 m	4.20 m	22.68	$L = 6.30 - .30 = 6.00$ m
					Total	50.15 cu m	
	Deduct —						
	Door openings	2	1.20 m	.30 m	2.10 m	1.51	
	Window openings ...	4	1.00 m	.30 m	1.50 m	1.80	
	Shelves ...	2	1.00 m	.20 m	1.50 m	0.60	Back of shelves 10 cm thick wall.
	Lintels over doors ...	2	1.50 m	.30 m	.15 m	0.14	Bearing 15 cm
	Lintels over windows ...	4	1.30 m	.30 m	.15 m	0.23	Bearing 15 cm
	Lintels over shelves	2	1.30 m	.30 m	.15 m	0.12	Bearing 15 cm
				Total of deduction		4.40	cu m
				Net	Total	45.75	cu m

Note : — Length of subsequent footing of short walls after 1st footing may be obtained simply by adding 10 cm from first footing.

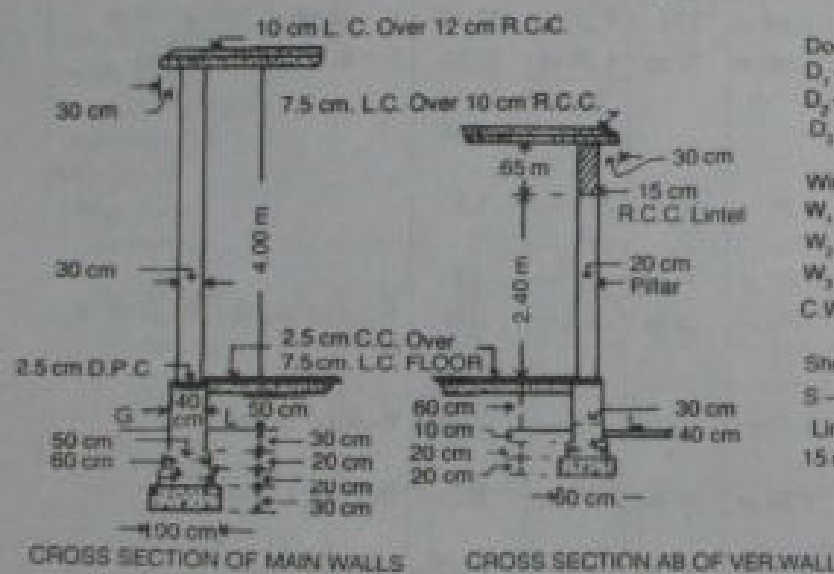
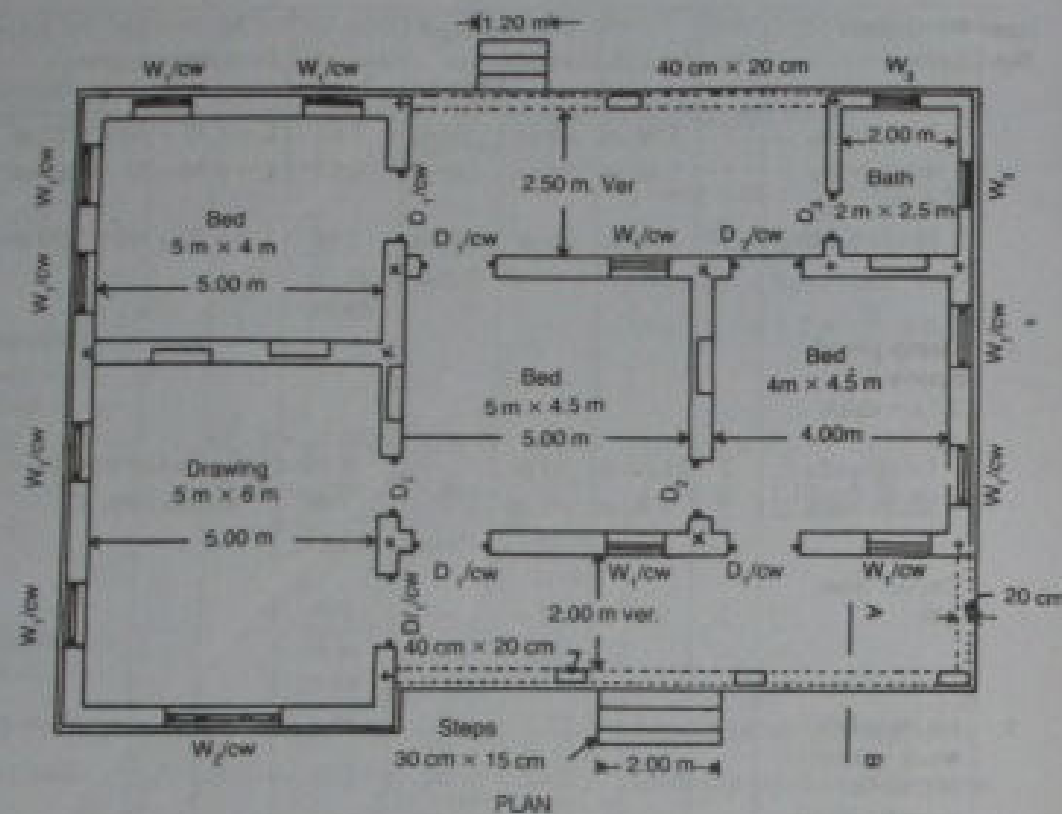

All walls of Drawing Rooms and Bed Rooms have same section.  
Bath Room walls have similar section.  
Note—No beam has been shown in the plan.

Doors:-  
D<sub>1</sub> - 120 cm × 210 cm (1.20 m × 2.10 m)  
D<sub>2</sub> - 100 cm × 200 cm (1.00 m × 2.00 m)  
D<sub>3</sub> - 75 cm × 180 cm (.75 m × 1.80 m)

Windows:-  
W<sub>1</sub> - 100 cm × 150 cm (1.00 m × 1.50 m)  
W<sub>2</sub> - 200 cm × 150 cm (2.00 m × 1.50 m)  
W<sub>3</sub> - 75 cm × 120 cm (.75 m × 1.20 m)  
C.W. - 75 cm × 60 cm (.75 m × .60 m)

Shelves:-  
S - 100 cm × 150 cm (1.00 m × 1.50 m)  
Lintel Over Doors, Windows Etc.  
15 cm R.B.

Fig. 2-7.

**Example 5(a).** — Estimate the quantities of the following items of a residential building from the given drawings (Fig. 2-7) :-

(1) Earthwork in excavation in foundation, (2) Lime concrete in foundation, (3) First class brickwork in 1 : 6 cement sand mortar in foundation and plinth, (4) 2.5 cm Damp proof course, and (5) First class brickwork in lime mortar in superstructure.

**Centre to centre lengths of wall —**

For estimating it is convenient to find the centre to centre lengths of different walls first. The centre to centre lengths of different walls have been worked out below :-

**Drawing and left hand side bed room combined —**

c. to c. long walls = 6.00 + 4.00 + .30 + 2 × .15 = 10.60 m.  
c. to c. short walls = 5.00 + 2 × .15 = 5.30 m.

**Bed rooms right side (both combined)**

c. to c. long walls = 5.00 + 4.00 + .30 + 2 × .15 = 9.60 m.  
c. to c. short walls = 4.50 + 2 × .15 = 4.80 m.

**Front verandah —**

Front wall c. to c. length = 5.00 + 4.00 + 2 × .30 +  $\frac{.30}{2}$  -  $\frac{.20}{2}$  = 9.65 m.

Side wall c. to c. length = 2.00 +  $\frac{.30}{2}$  +  $\frac{.20}{2}$  = 2.25 m.

**Back verandah including bath room —**

c. to c. long wall (rear wall including bath room) 9.65 m same as front ver. wall.

c. to c. length of side wall of bath room = 2.50 +  $\frac{.30}{2}$  +  $\frac{.20}{2}$  = 2.75 m.

## DETAILS OF MEASUREMENT AND CALCULATION OF QUANTITIES (Ex. 5a)

Item No.	Particulars of Items	No.	Length	Breadth	Height or Depth	Quantity	Explanatory note
1.	<b>Earthwork in excavation in foundation — Drawing room and left bed room —</b>						
	Long walls	2	11.50 m	.90 m	1.00 m	20.70	$L = 10.60 + .90 = 11.50 \text{ m}$
	Short walls	3	4.40 m	.90 m	1.00 m	11.88	$L = 5.30 - .90 = 4.40 \text{ m}$
	<b>Bed rooms right side (both) —</b>						
	Long walls	2	9.60 m	.90 m	1.00 m	17.28	$L = 9.60 - \frac{.90}{2} + \frac{.90}{2} = 9.60 \text{ m}$
	Short walls	2	3.90 m	.90 m	1.00 m	7.02	$L = 4.80 - .90 = 3.90 \text{ m}$
	<b>Front verandah</b>						
	Front long wall	1	9.50 m	.60 m	.50 m	2.85	$L = 9.65 - \frac{.90}{2} + \frac{.60}{2} = 9.50 \text{ m}$
	Side short wall	1	1.50 m	.60 m	.50 m	0.45	$L = 2.25 - \frac{.90}{2} - \frac{.60}{2} = 1.50 \text{ m}$
	<b>Back verandah including bath room — Long wall (rear wall including bath)</b>	1	9.50 m	.60 m	.50 m	2.85	$L = 9.65 - \frac{.90}{2} + \frac{.60}{2} = 9.50 \text{ m}$
	Short walls (remaining walls of bath)	2	2.00 m	.60 m	.50 m	1.20	$L = 2.75 - \frac{.90}{2} - \frac{.60}{2} = 2.00 \text{ m}$
2.	<b>Lime concrete in foundation — Drawing and left bed room</b>				Total	64.23 cu m	
	Long walls	2	11.50 m	.90 m	.30 m	6.21	L same as for earthwork in excavation
	Short walls	3	4.40 m	.90 m	.30 m	3.56	
	<b>Bed room right side (both) —</b>						
	Long walls	2	9.60 m	.90 m	.30 m	5.18	L same as for earthwork in excavation.
	Short walls	2	3.90 m	.90 m	.30 m	2.11	" "
	<b>Front verandah</b>						
	Front long wall	1	9.70 m	.60 m	.20 m	1.16	$L = 9.65 - \frac{.50}{2} + \frac{.60}{2} = 9.70 \text{ m}$
	Side short wall	1	1.70 m	.60 m	.20 m	0.20	$L = 2.25 - \frac{.50}{2} - \frac{.60}{2} = 1.70 \text{ m}$

(Ex. 5a Contd.)

Item No.	Particulars of Items	No.	Length	Breadth	Height or Depth	Quantity	Explanatory note
	<b>Back verandah, including bath room</b>						
	Long wall including bath	1	9.70 m	.60 m	.20 m	1.16	$L = 9.65 - \frac{.50}{2} + \frac{.60}{2} = 9.70 \text{ m}$
	Short wall (remaining walls of bath)	2	2.20 m	.60 m	.20 m	0.53	$L = 2.75 - \frac{.50}{2} - \frac{.60}{2} = 2.20 \text{ m}$
	<b>Total</b>					20.11 cu m	
3.	<b>1st class brickwork in foundation and plinth in 1 : 6 cement mortar Drawing and left bed room Long walls —</b>						
	1st footing	2	11.20 m	.60 m	.20 m	2.69	$L = 10.60 + .60 = 11.20 \text{ m}$
	2nd footing	2	11.10 m	.50 m	.20 m	2.22	$L = 11.20 - 2 \times .05 = 11.10 \text{ m}$
	Plinth wall above footing	2	11.00 m	.40 m	.90 m	7.92	$L = 11.10 - .10 = 11.00 \text{ m}$
	<b>Short walls —</b>						
	1st footing	3	4.70 m	.60 m	.20 m	1.69	$L = 5.30 - .60 = 4.70 \text{ m}$
	2nd footing	3	4.80 m	.50 m	.20 m	1.44	$L = 4.70 + 2 \times .05 = 4.80 \text{ m}$
	Plinth wall above footing	3	4.90 m	.40 m	.90 m	5.29	$L = 4.80 + .10 = 4.90 \text{ m}$
	<b>Bed rooms right side (both) —</b>						
	<b>Long walls —</b>						
	1st footing	2	9.60 m	.60 m	.20 m	2.31	$L = 9.60 - \frac{.60}{2} + \frac{.60}{2} = 9.60 \text{ m}$
	2nd footing	2	9.60 m	.50 m	.20 m	1.92	$L = 9.60 - \frac{.50}{2} + \frac{.50}{2} = 9.60 \text{ m}$
	Plinth wall above footing	2	9.60 m	.40 m	.90 m	6.91	$L = 9.60 - \frac{.40}{2} + \frac{.40}{2} = 9.60 \text{ m}$

Item No.	Particulars of Items	No.	Length	Breadth	Height or Depth	Quantity	Explanatory note
	Bed room right side —						
	Long walls	2	9.60 m	.30 m	4.00 m	23.04	$L = 9.60 - \frac{.30}{2} + \frac{.30}{2} = 9.60 \text{ m}$
	Short walls	2	4.50 m	.30	4.00 m	10.80	$L = 4.80 - .30 = 4.50 \text{ m}$
	Front verandah						
	Front wall as solid	1	9.60 m	.20 m	3.05 m	5.86	$L = 9.65 - \frac{.30}{2} + \frac{.20}{2} = 9.60 \text{ m}$
	Side wall as solid	1	2.00 m	.20 m	3.05 m	1.22	
	Back verandah including bath room —						
	Back long wall as solid	1	9.60 m	.20 m	3.05 m	5.86	L same as front verandah.
	Side and inter walls of bath	2	2.50 m	.20 m	3.05 m	3.05	
					Total	93.99	
						cu m	
	<b>Deduct —</b>						
	Door openings						
	D. openings D <sub>1</sub>	6	1.20 m	.30 m	2.10 m	4.54	
	D. openings D <sub>2</sub>	2	1.00 m	.30 m	2.00 m	1.20	
	D. openings D <sub>3</sub>	1	0.75 m	.20 m	1.80 m	0.27	
	Window openings						
	W. openings W <sub>1</sub>	11	1.00 m	.30 m	1.50 m	4.95	
	W. openings W <sub>2</sub>	1	2.00 m	.30 m	1.50 m	0.90	
	W. openings W <sub>3</sub>	2	0.75 m	.20 m	1.20 m	0.36	
	Clerestory window (C.W.) opening	18	0.75 m	.30 m	0.60 m	2.43	
	Shelves opening	5	1.00 m	.20 m	1.50 m	1.50	Back of shelves 10 cm thick wall.
	Front verandah opening in between pillars	1	8.40 m	.20 m	2.40 m	4.03	$L = 9.60 - 3 \times .40 = 8.40 \text{ m}$
	Front verandah opening side	1	2.00 m	.20 m	2.40 m	0.96	
	Back verandah opening	1	6.80 m	.20 m	2.40 m	3.26	$L = 9.60 - 2.40 - .40 = 6.80 \text{ m}$

(Ex. 5a Contd.)

Item No.	Details of Items	No.	Length	Breadth	Height or Depth	Quantity	Explanatory note	
	Lintels —							
	Over doors							
	D. doors D <sub>1</sub>	6	1.50 m	.30 m	.15 m	0.405	Bearing 15 cm	
	D. doors D <sub>2</sub>	2	1.30 m	.30 m	.15 m	0.117	Bearing 15 cm	
	D. doors D <sub>3</sub>	1	.95 m	.20 m	.15 m	0.029	Bearing 10 cm	
	Over windows							
	W. windows W <sub>1</sub>	11	1.30 m	.30 m	.15 m	0.644	Bearing 15 cm	
	W. windows W <sub>2</sub>	1	2.30 m	.30 m	.15 m	0.103	Bearing 15 cm	
	O. windows W <sub>3</sub>	2	.95 m	.20 m	.15 m	0.057	Bearing 10 cm	
	Over C.W.	18	.95 m	.30 m	.15 m	0.770	Bearing 10 cm	
	Over shelves	5	1.30 m	.30 m	.15 m	0.293	Bearing 15 cm	
	Verandah lintels							
	Front	1	9.75 m	.20 m	.15 m	0.293	$L = 9.60 + .15 = 9.75 \text{ m}$	
	Side	1	2.15 m	.20 m	.15 m	0.065	$L = 2.00 + .15 = 2.15 \text{ m}$	
	Back	1	7.50 m	.20 m	.15 m	0.225	$L = 9.60 - 2.40 + 2 \times .15 = 7.50 \text{ m}$	
					Total of deduction	27.401	cu m	
					Net	Total	66.59	cu m

Note:— Verandah walls above lintel, verandah pillars, and bath room walls may be taken separately and no deduction for verandah openings need be made.

## ABSTRACT OF QUANTITIES (Ex. 5a)

1. Earthwork in excavation in foundation	64.23	cu m.
2. Lime concrete in foundation	20.22	cu m.
3. 1st class brickwork in foundation and plinth in 1:6 cement mortar	44.95	cu m.
4. 2.5 cm damp proof course	24.76	sq m.
5. 1st class brickwork in superstructure in lime mortar	66.59	cu m.

Note:— Steps have not been taken into consideration as the object of this example is to illustrate the method of estimating of walls only.

## METHOD II

**Centre Line Method.**— In this method known as centre line method sum-total length of centre lines of walls, long and short, has to be found out. Find the total length of centre lines of walls, of same type, long and short having same type of foundations and footings and then find the quantities by multiplying the total centre length by the respective breadth and the height. In this method, the length will remain same for excavation in foundation, for concrete in foundation, for all footings and for superstructure (with slight difference when there are cross walls or number of junctions). This method is quick but requires special attention and consideration at the junctions, meeting points of partition or cross walls, etc.

For rectangular, circular polygonal (hexagonal, octagonal, etc.) buildings having no inter or cross walls, this method is quite simple. For buildings having cross or partition walls, for every junction of partition or cross walls with main walls, special consideration shall have to be made to find the correct quantity. For each junction half breadth of the respective item or footing is to be deducted from the total centre length. Thus in the case of a building with one partition wall or cross wall having two junctions, for earthwork in foundation trench and foundation concrete deduct one breadth of trench or concrete from the total centre length (half breadth for one junction and one breadth  $(2 \times \frac{1}{2} = \text{one})$  for two junctions). For footings, similarly deduct one breadth of footing for two junctions from the total centre length, and so on. If two walls come from opposite directions and meet a wall at the same point, then there will be two junctions.

For building having different types of walls, each set of walls shall have to be dealt separately. Find the total centre length of all walls of one type and proceed in the same manner as described above. Similarly find the total centre length of walls of second type and deal this separately, and so on.

In the case of a building having different type of walls, suppose the outer (main) walls are of A type and inter cross walls are of B type, then all A type walls shall be taken jointly first, and then all B type walls shall be taken together separately. In such cases no deduction of any kind need be made for A type walls, but when B type walls are taken, for each junction deduction of half breadth of A type wall (main wall) shall have to be made from the total centre length of walls.

It may be noted that at corners of the building where two walls are meeting no subtraction or addition is required.

When there are number of footings, the length of the first footing is to be determined by deducting half breadth of footing per junction from the total centre line length and then the length of the subsequent footing can be obtained simply by adding one offset of footing i.e. 5 cm for every junction to the length of the previous footing.

The examples 3(a), 4(a) and 5(a) which have been solved by method I in the previous pages, have been solved again under examples 3(b), 4(b) and 5(b) in the following pages, by method II to illustrate this method. These illustrations will make this method quite clear.

**Note.**— Student should practice method I first and when they have become sufficiently acquainted with method I, then only they should take up the method II.

**Example 3(b).**— Estimate by centre line method the quantities of the following items of a single room building Fig. 2-3 of example 3a (page 31)— (1) Earthwork in excavation in foundation, (2) Concrete in foundation, (3) Brickwork in foundation and plinth, and (4) Brickwork in superstructure.

Total centre length of walls =  $AB + BC + CD + DA = 5.30 + 4.30 + 5.30 + 4.30 = 19.20$  m  
Fig. 2-8 represents the foundation trench plan.

If the total centre length is multiplied by the breadth and the depth we get the quantity of earthwork in excavation. By doing so we take certain portion twice and leave an equal portion but this does not affect the quantity.

The quantity of excavation =  $AB \times 90 \text{ cm} \times 90 \text{ cm} + BC \times 90 \text{ cm} \times 90 \text{ cm} + CD \times 90 \text{ cm} \times 90 \text{ cm} + DA \times 90 \text{ cm} \times 90 \text{ cm}$ . It may be noticed that the portions P, Q, R and S marked with double hatch lines come twice while the portions K, L, M, N left blank do not come at all, but these portions being equal in magnitude, we get the correct quantity.

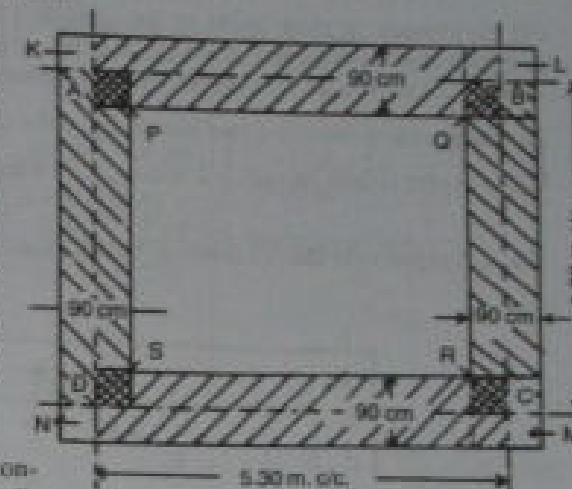

The same principle applies to foundation concrete, footings, plinth wall and superstructure wall.

Fig. 2-8

## DETAILS OF MEASUREMENT AND CALCULATION OF QUANTITIES (Ex. 3b)

Item No.	Description of Items	No.	Length	Breadth	Height or Depth	Quantity	Explanatory notes
1.	Earthwork in excavation in foundation	1	19.20 m	.90 m	.90 m	15.55 cu m	Total centre length of all walls = 19.20 m
2.	Concrete in foundation	1	19.20 m	.90 m	.30 m	5.18 cu m	
3.	Brickwork in foundation and plinth						
	1st footing	1	19.20 m	.60 m	.30 m	3.46	
	2nd footing	1	19.20 m	.50 m	.30 m	2.88	
	Plinth wall	1	19.20 m	.40 m	.60 m	4.61	
					Total	10.95 cu m	
4.	Brickwork in superstructure	1	19.20 m	.30 m	3.50 m	20.16 cu m	Door and window openings, lintels, etc. to be deducted.

**Note.**— The above may be compared with the solution by method I given in page 33.

**Example 4(b).**— Estimate by *centre line method* the quantities of the following items of a two roomed building Fig. 2-6 Example 4a (page 35)—

(1) Earthwork in excavation in foundation, (2) Lime concrete in foundation, (3) 1st class brickwork in cement mortar 1:6 in foundation and plinth, (4) 2.5 cm c.c. damp proof course, and (5) 1st class brickwork in lime mortar in superstructure.

In this problem there are two junctions of the inter wall with the main wall.

Total centre length of wall = 2 × c. to. c. of long wall + 3 × c. to. c. of short wall  
= 2 × 10.60 + 3 × 6.30 = 40.10 m

Fig. 2-9 represents the foundation trench plan.

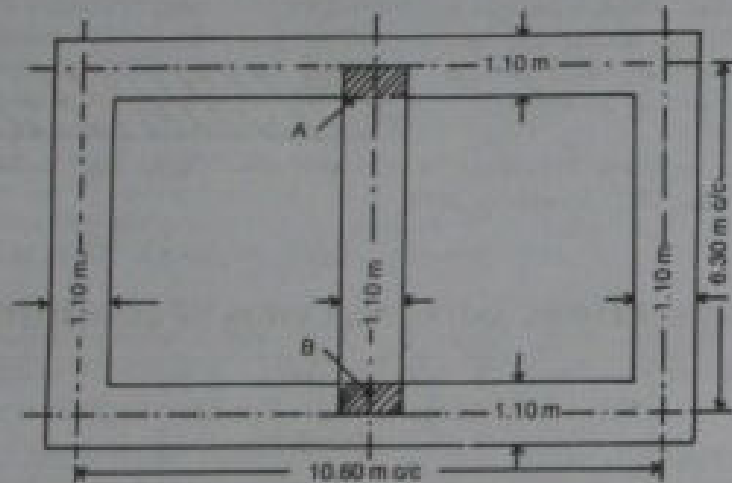

Fig. 2-9

If the total centre length is multiplied by the breadth and depth, at the junction the portions A and B shown by hatch lines in Fig. 2-9 come twice, and we get the quantity in excess by these portions, and these excesses shall have to be deducted. The deduction may be effected reducing the centre length by half breadth for each junction.

Thus the quantity of earthwork in excavation—

$$= [\text{Total centre length} - (2 \times \frac{1}{2} \text{ breadth})] \times \text{breadth} \times \text{depth.}$$

$$= (40.10 - 2 \times \frac{1}{2} \times 1.10) \times 1.10 \times 1.00 = 39.00 \times 1.10 \times 1.00 = 42.90 \text{ cu m.}$$

The same principle applies to foundation concrete, to footings, plinth wall and superstructure wall. At every stage deduction of half breadth of the main wall at that particular level shall have to be made per junction (*i.e.* one breadth for two junctions) from the total centre length, and this net centre length after deduction shall be multiplied by the respective breadth and the height or depth to get quantities.

The estimate of the quantities of this Example 4(b) is as follows:—

DETAILS OF MEASUREMENT AND CALCULATION OF QUANTITIES (Ex. 4b)

Item No.	Particulars of Items	No.	Length	Breadth	Height or Depth	Quantity	Explanatory notes
1.	Earthwork in excavation in foundation	1	39.00 m	1.10 m	1.00 m	42.90 cu m	Total centre length = 40.10 m $L = 40.10 - 2 \times \frac{1.10}{2} = 39.00 \text{ m}$
2.	Lime concrete in foundation	1	39.00 m	1.10 m	.30 m	12.87 cu m	L same as above.
3.	1st class brick-work in 1:6 cement mortar in foundation and plinth—						
	1st footing	1	39.30 m	.80 m	.20 m	6.29	$L = 40.10 - 2 \times \frac{.80}{2} = 39.30 \text{ m}$
	2nd footing	1	39.40 m	.70 m	.10 m	2.76	$L = 40.10 - 2 \times \frac{.70}{2} = 39.40 \text{ m}$
	3rd footing	1	39.50 m	.60 m	.10 m	2.37	$L = 40.10 - 2 \times \frac{.60}{2} = 39.50 \text{ m}$
	4th footing	1	39.60 m	.50 m	.10 m	1.98	$L = 40.10 - 2 \times \frac{.50}{2} = 39.60 \text{ m}$
	Plinth wall above footing	1	39.70 m	.40 m	.80 m	12.70	$L = 40.10 - 2 \times \frac{.40}{2} = 39.70 \text{ m}$
						Total	26.10 cu m
4.	Damp proof course 2.5 cm c.c.	1	39.70 m	.40 m	—	15.88	$L = 40.10 - 2 \times \frac{.40}{2} = 39.70 \text{ m}$
	Deduct door sill	2	1.20 m	.40 m	—	0.96	
						Net	14.92 cu m
5.	1st class brick-work in lime mortar in superstructure	1	39.80 m	.30 m	4.20 m	50.15	$L = 40.10 - 2 \times \frac{.30}{2} = 39.80 \text{ m}$
	Deduct door, window, shelf openings and lintels	1	Same as per page 37	as per detail in		4.40	Deduction to be made as usual.
						Net	45.75 cu m

**Note.**— The length of 2nd footing can be obtained simply by adding 10 cm (*i.e.*  $2 \times 5 \text{ cm}$ ) to the length of the 1st footing, the length of 3rd footing by adding 10 cm to the length of the 2nd footing and so on.

This may be compared with the solution by method I worked out in pages 36-37.



**Example 5(b).**— Estimate by *centre line method* the quantities of the following items of a residential building, Fig. 2-7 of Example 5a (page 38).

(1) Earthwork in excavation in foundation, (2) Lime concrete in foundation, (3) First class brickwork in 1:6 cement sand mortar in foundation and plinth, (4) Damp proof course and (5) First class brickwork in lime mortar in superstructure.

Total centre length of all 30 cm walls (same type) of main rooms  
= Total centre length of walls of drawing and left side bed room + Total centre length of walls of bed rooms right side  
=  $(2 \times c. \text{ to } c. \text{ length of long wall} + 3 \times c. \text{ to } c. \text{ length of short wall})$   
+  $(2 \times c. \text{ to } c. \text{ length of long wall} + 2 \times c. \text{ to } c. \text{ length of short wall})$   
=  $(2 \times 10.60 + 3 \times 5.30) + (2 \times 9.60 + 2 \times 4.80)$   
=  $37.10 + 28.80 = 65.90 \text{ m}$ .

Number of junctions for these walls is 6 marked 'x' in the plan Fig. 2-7, page 38 and all these junctions are with main walls of 30 cm.

Total centre length of all 20 cm walls (same type) of front verandah, back verandah and bath room

=  $(c. \text{ to } c. \text{ length of front wall} + c. \text{ to } c. \text{ length of side wall}) + (c. \text{ to } c. \text{ length of back verandah long wall including bath} + 2 \times c. \text{ to } c. \text{ length of cross walls of bath room})$   
=  $(9.65 + 2.25) + (9.65 + 2 \times 2.75) = 11.90 + 15.15 = 27.05 \text{ m}$ .

Number of junctions of these wall is 5 is marked '+' and one is marked '-' in the plan Fig. 2-7, page 38.

Five junctions are with main walls of 30 cm and one junction with similar wall of 20 cm.

See page 39 for centre length of different walls.

The estimate of the different items by centre line method is as follows —

Item No.	Particulars of Items	No.	Length	Breadth	Height or Depth	Quantity	Explanatory notes
1.	Earthwork in excavation in foundation —						
	Wall of main room (six junctions) ...	1	63.20m	.90 m	1.00 m	56.88	$L = 65.90 - 6 \times \frac{90}{2} = 63.20\text{m}$
	Walls of verandahs including bath (five and one junctions) ...	1	24.50 m	.60 m	.50 m	7.35	$L = 27.05 - 5 \times \frac{90}{2} - 1 \times \frac{60}{2} = 24.50 \text{ m}$
	Total				64.23 cu m		
2.	Lime concrete in foundation —						
	Walls of main rooms ...	1	63.20 m	.90 m	.30 m	17.06	L same as above.
	Walls of verandah and bath ...	1	25.50 m	.60 m	.20 m	3.06	$L = 27.05 - 5 \times \frac{50}{2} - 1 \times \frac{60}{2} = 25.50 \text{ m}$ (Minus half breadth per junction at the same level)
	Total				20.12 cu m		
3.	1st class brick-work in foundation and plinth in 1:6 cement mortar —						
	Walls of main rooms —						
	1st footing ...	1	64.10 m	.60 m	.20 m	7.69	$L = 65.90 - 6 \times \frac{60}{2} = 64.10\text{m}$
	2nd footing ...	1	64.40 m	.50 m	.20 m	6.44	$L = 65.90 - 6 \times \frac{50}{2} = 64.40\text{m}$
	Plinth wall above footing ...	1	64.70 m	.40 m	.90 m	23.29	$L = 65.90 - 6 \times \frac{40}{2} = 64.70\text{m}$ (Length of subsequent footing after first can be obtained by adding $6 \times 5 = 30 \text{ cm}$ to the previous footing).
	Walls of verandah and bath —						
	Footing ...	1	25.85 m	.40 m	.20 m	2.07	$L = 27.05 - 5 \times \frac{40}{2} - 1 \times \frac{40}{2} = 25.85 \text{ m}$
	Plinth wall above footing	1	25.90 m	.30 m	.70 m	5.44	$L = 27.05 - 5 \times \frac{40}{2} - 1 \times \frac{30}{2} = 25.90 \text{ m}$
	Total				44.93 cu m		

Item No.	Particulars of Items	No.	Length	Breadth	Height or Depth	Quantity	Explanatory notes
4.	2.5 cm Damp proof course						
	Walls of main rooms	1	64.70 m	.40 m	—	25.88	L same as for plinth wall.
	Verandah pillars	4	0.50 m	.30 m	—	0.60	
	Bath room (total of 3 walls)	1	7.30 m	.30 m	—	2.19	$L = (2.20 + 2 \times .15) + 2 \times (2.75 - \frac{.40}{2} - \frac{.30}{2}) = 7.30 \text{ m}$
						Total	28.67
	Deduct door sills	Same page	as per 43	detail in		3.91	Details of deduction as usual
			Net	Total		24.76	sq m
5.	1st class brick-work in superstructure in lime mortar—						
	Walls of main rooms	1	65.00 m	.30 m	4.00 m	78.00	$L = 65.90 - 6 \times \frac{.30}{2} = 65.00 \text{ m}$
	Walls of verandah and bath (as solid)	1	26.20 m	.20 m	3.05 m	15.98	$L = 27.05 - 5 \times \frac{.30}{2} - 1 \times \frac{.20}{2} = 26.20 \text{ m}$
						Total	93.98
	Deduct openings and lintels	Same pages	as per 44-45	detail in		27.40	Details of deduction as usual.
			Net	Total		66.58	cu m

Note.— This solution may be compared with that of by method I worked out in pages 40-45.

Method I, 'Long wall and Short wall' method as explained in pages 29 to 45 is generally followed in the Engineering Department. The measurement of the work done, is taken separately for each wall for preparing bill for payment and the quantity for each wall as per measurement may be compared with the estimated quantity.

## ARCH MASONRY CALCULATION

The quantities of masonry work in arch is calculated by multiplying the mean length of arch by breadth of wall and by the thickness of arch. In the case of culvert the quantity of arch masonry work is equal to the length of arch face to face  $\times$  mean length of arch  $\times$  thickness of arch.

Case I. Segmental Arch with span and angle given. — Arch of span  $S$  subtending an angle  $\theta$  at the centre.

$s$  = span,  $\theta$  = angle at the centre,  $r$  = radius,  
 $r_m$  = mean radius,  
 $l_m$  = mean length of arch,  $t$  = thickness of arch,  
 $b$  = breadth of wall,

$$\sin \frac{\theta}{2} = \frac{s/2}{r} \therefore r = \frac{s}{2} \times \frac{1}{\sin \frac{\theta}{2}}, \quad r_m = r + \frac{t}{2}$$

$$\frac{l_m}{2\pi r_m} = \frac{\theta}{360} \therefore l_m = 2\pi r_m \times \frac{\theta}{360}$$

$l_m$  can be found.

Quantity of arch masonry work  $Q$  = mean length of arch  $\times$  breadth of wall  $\times$  thickness of arch =  $l_m \times b \times t$ .

Illustration I. — An arch of 2.50 m span subtends an angle of  $80^\circ$  at the centre. The thickness of arch is 30 cm and the breadth of wall is 40 cm. Calculate the quantity of arch masonry work.

$$\text{Radius } r = \frac{s}{2} \times \frac{1}{\sin 40^\circ} = \frac{2.50}{2} \times \frac{1}{.6428} = 1.945 \text{ m}$$

$$\text{Mean radius } r_m = r + \frac{t}{2} = 1.945 + \frac{.30}{2} = 2.095 \text{ m}$$

$$\text{Mean length of arch } l_m = 2\pi r_m \times \frac{\theta}{360} = 2 \times \frac{22}{7} \times 2.095 \times \frac{80}{360} = 2.93 \text{ m}$$

$$\text{Quantity of arch masonry} = l_m \times \text{breadth of wall} \times \text{thickness of arch} = 2.93 \times .40 \times .30 = .352 \text{ cu m.}$$

Case II. Segmental Arch of  $60^\circ$  Arches over doors and windows are usually segmental subtending an angle of  $60^\circ$  at the centre.  $60^\circ$  arch forms an equilateral triangle on the span with radii

$l_m$  = mean length of arch,  $r_m$  = mean radius,

$s$  = span,

$r$  = radius,

$$r = s, \text{ and } r_m = r + \frac{t}{2} \quad \frac{l_m}{2\pi r_m} = \frac{60^\circ}{360^\circ} = \frac{1}{6}$$

$$l_m = \frac{1}{6} \times 2\pi r_m = \frac{1}{3} \pi r_m, \quad l_m \text{ can be found.}$$

$$\text{Quantity } Q = l_m \times \text{breadth of wall} \times \text{thickness of arch} = l_m \times b \times t$$

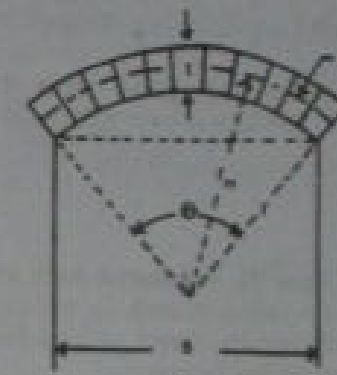

Fig. 2-10

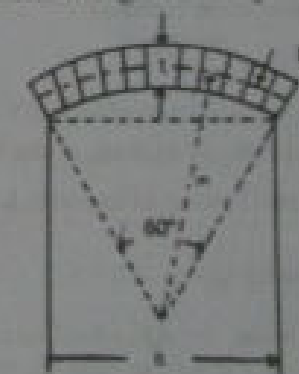

Fig. 2-11

**Illustration II.** — Calculate the quantity of brickwork in a  $60^\circ$  arch over a door of 1.20 m width. The arch is 20 cm thick and the thickness of the wall is 30 cm.

$$r = 1.20 \text{ m}, \quad r_m = r + \frac{t}{2} = \left(1.20 + \frac{.20}{2}\right) = 1.30 \text{ m}$$

$$l_m = \frac{1}{3} \pi r_m = \frac{1}{3} \times \frac{22}{7} \times 1.30 = 1.36 \text{ m}$$

$$\text{Breadth of wall } b = .30 \text{ m, Thickness of arch } t = .20 \text{ m}$$

$$\therefore Q = l_m \times b \times t = 1.36 \times .30 \times .20 = .082 \text{ cu m}$$

**Case III. Segmental Arch with span and rise given —**

$r$  = radius of arch i.e. of intrados,  $r_m$  = radius of mean arc.  
 $l$  = length of arch of intrados,  $l_m$  = length of mean arc.

From similar figures —

$$\frac{l_m}{l} = \frac{r_m}{r}, \text{ or } l_m = l \times \frac{r_m}{r}$$

To find radius  $r$  —

$$a^2 = h(d - h), \text{ where } d = \text{dia. of intrados.}$$

$$a = \text{semi chord} = \frac{1}{2} \text{ span} = \frac{s}{2}$$

$h$  = rise of arch (given)

Hence  $d$  can be found, and  $r = d/2$

$$\text{From the above it can also be proved that } r = \frac{h}{2} + \frac{s^2}{8h}$$

Radius  $r$  can be found by first principle or directly by the formula.

$$\text{Mean radius } r_m = r + \frac{t}{2}, \text{ where } t = \text{thickness of arch.}$$

To find length of arc of intrados  $l$ :

$$\text{Mensuration formula, } l = \frac{8b - 2a}{3}$$

$$b = \sqrt{a^2 + h^2}$$

$a$  and  $h$  being known,  $b$  can be determined, and hence  $l$  can be found.

$$r, r_m \text{ and } l \text{ being calculated, } l_m \text{ can be found } l_m = l \times \frac{r_m}{r}$$

$$\text{Quantity } Q = l_m \times b \times t$$

**Note.** — After finding radius  $r$ , the angle  $\theta$  subtended at the centre may also be determined as in Case I above in page 53 and then  $l_m$  may be found.

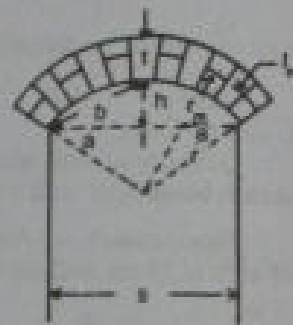

Fig. 2-12

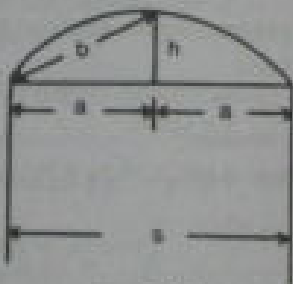

Fig. 2-13

**Illustration III.** — Calculate the quantity of brickwork in a segmental arch of 2.20 m span, 50 cm rise and 30 cm thick. The breadth of the wall is 30 cm.

$$\text{Mean length of arch } l_m = l \times \frac{r_m}{r}$$

$$a^2 = h(d - h), \quad a = \frac{s}{2} = \frac{2.20}{2} = 1.10, \quad h = .50$$

$$\therefore (1.1)^2 = .5(d - .5)$$

solving  $d = 2.92 \text{ m}$

$$r = \frac{d}{2} = \frac{2.92}{2} = 1.46 \text{ m}$$

$$\therefore r_m = r + \frac{t}{2} = 1.46 + \frac{.30}{2} = 1.61 \text{ m}$$

$$l = \frac{8b - 2a}{3}, \quad b = \sqrt{a^2 + h^2} = \sqrt{1.1^2 + .5^2} = 1.21 \text{ m}$$

$$\therefore l = \frac{(8 \times 1.21) - (2 \times 1.10)}{3} = 2.49 \text{ m}$$

$$\text{Mean length } l_m = l \times \frac{r_m}{r} = 2.49 \times \frac{1.61}{1.46} = 2.75 \text{ m}$$

$$\text{Quantity of arch work } Q = l_m \times b \times t = 2.75 \times .30 \times .30 = .247 \text{ cu m.}$$

**Case IV. Semi-circular Arches —**

$s$  = span,

$r_m$  = mean radius,

$l_m$  = mean length of arch

$$\text{Radius } r = \frac{s}{2}$$

$r$  = radius of arch,  
 $h$  = rise,

$$\text{Rise } h = \frac{s}{2}$$

$$\text{Mean Radius } r_m = r + \frac{t}{2} = \frac{s}{2} + \frac{t}{2}$$

$$\text{Mean length of arch } l_m = \pi r_m = \frac{22}{7} \times \left(\frac{s}{2} + \frac{t}{2}\right)$$

$$\text{Quantity of arch masonry } Q = l_m \times b \times t$$

**Illustration IV.** — Calculate the quantity of brickwork in a semi-circular arch of 2.00 m span, thickness of the arch is 30 cm and the breadth of the wall is 40 cm.

$$\text{Radius of arch } r = \frac{2.00}{2} = 1.00 \text{ m}$$

$$\text{Mean Radius } r_m = r + \frac{t}{2} = 1.00 + \frac{.30}{2} = 1.15 \text{ m}$$

$$\text{Mean length } l_m = \pi \times r_m = \frac{22}{7} \times 1.15 = 3.61 \text{ m}$$

$$\text{Quantity of arch work } Q = l_m \times b \times t = 3.61 \times .40 \times .30 = .433 \text{ cu m.}$$

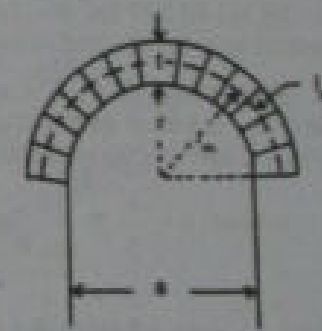

Fig. 2-14

**Case V. Flat Arches.** — May be used over doors and windows for small spans, but a small camber should be given.

Flat arch usually subtends an angle of 60° at the centre and forms an equilateral triangle.

Inclined thickness of arch at the springing point  $t_1 = \frac{t}{\sin 60^\circ} = \frac{t}{.866} = 1.15 t$

Mean length of arch  $l_m = s + \frac{t_1}{2}$

Quantity of arch masonry work  $Q = l_m \times b \times t$

For practical purposes  $t_1$  may be considered as equal to  $t$  and mean length of arch may be taken as,  $l_m = s + \frac{t}{2}$

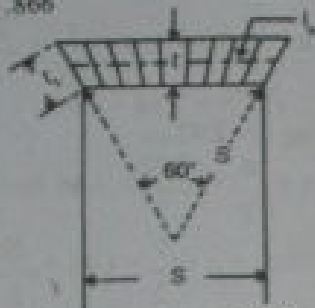

Fig. 2-15

**Illustration V.** — Calculate the quantity of arch work in a flat arch over a door of 1.20 m width. The thickness of arch is 30 cm and the breadth of wall is 30 cm.

$$s = 1.20 \text{ m}, t_1 = \frac{t}{\sin 60^\circ} = 1.15 t = 1.15 \times .30 = .345 \text{ m}$$

$$\text{Mean length } l_m = s + \frac{t_1}{2} = 1.20 + \frac{.345}{2} = 1.372 \text{ m}$$

$$\text{Quantity of arch work } Q = l_m \times b \times t = 1.372 \times .30 \times .30 = 1.23 \text{ m}^3$$

**SEMI-ELLIPTICAL ARCHES** may be considered as segmental arches, and the same method may be adopted to calculate the quantities which is sufficient for practical purposes.

**Illustration VI.** — The arch of a culvert, subtend an angle of 120° at the centre. The span of the arch is 5.00 m and the thickness of the arch is 50 cm. The length of the arch is 8.00 m from face to face. Calculate the quantities of arch masonry work, and cement plastering in the soffit of arch.

$$\text{Radius, } r = \frac{s}{2} \times \frac{1}{\sin \theta}$$

where  $s = \text{span} = 5.00 \text{ m}$ ,  $\theta = \text{angle subtended at the centre} = 120^\circ$

$$= \frac{5.00}{2} \times \frac{1}{\sin 60^\circ} = 2.5 \times \frac{1}{.866} = 2.886 \text{ m}$$

$$\text{Mean radius, } r_m = r + \frac{t}{2}, \text{ where } t = \text{thickness of arch} = 50 \text{ cm} = .50 \text{ m}$$

$$= 2.886 + \frac{.50}{2} = 3.136 \text{ m}$$

Mean length of arc,  $l_m =$

$$\frac{l_m}{2\pi r_m} = \frac{\theta}{360} \quad l_m = 2\pi r_m \times \frac{\theta}{360} = 2 \times \frac{22}{7} \times 3.136 \times \frac{120}{360} = 6.57 \text{ m}$$

Length of arch from face to face,  $L = 8.00 \text{ m}$  (given).

**Quantity of arch masonry** = Length of arch  $\times l_m \times t = 8.00 \times 6.57 \times .50 = 26.28 \text{ cu m}$

Arc length of intrados,  $l =$

$$\frac{l}{l_m} = \frac{r}{r_m} \quad l = l_m \times \frac{r}{r_m} = 6.57 \times \frac{2.886}{3.136} = 6.05 \text{ m}$$

**Area of soffit plastering** = Arc length of intrados  $\times$  length of arch =  $6.05 \times 8.00 = 48.40 \text{ sq m}$ .

**Note.** — For building work the mean length of the arch may be found from the drawing by measuring with divider or thread, and then the quantity calculated. But for big arches, as culverts, the correct mean length should be found by theoretical calculations. The estimate of a building having various types of arches has been given in Chapter 4.

**ESTIMATING OF STEPS**

**Problem** — Estimating the quantities of Earthwork, Concrete, Brickwork and Finishing work of different types of steps from given drawings.

Steps are usually constructed when the construction of the building has progressed sufficiently and the earthwork in foundation for step needs excavation afresh. The earthwork in excavation for step is usually neglected.

1. Estimate of simple step given in Fig. 2-16.

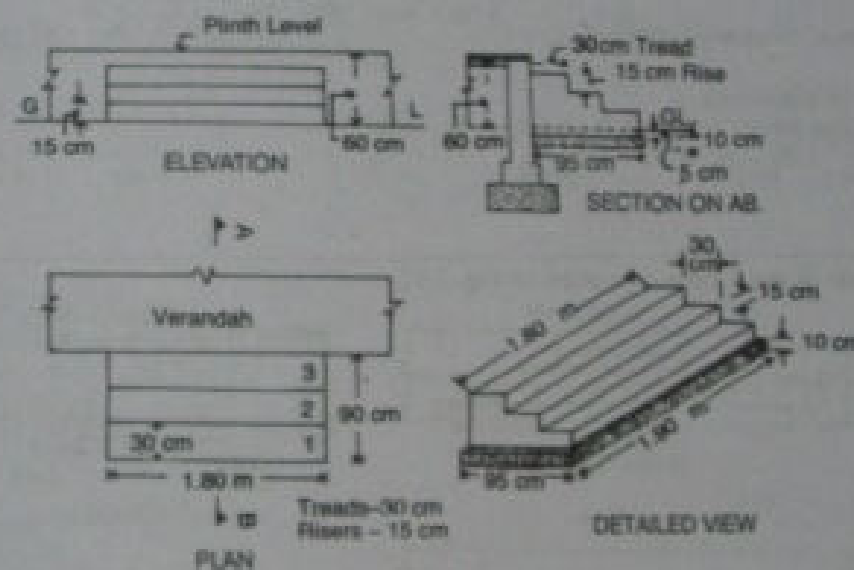

Fig. 2-16

Surface in steps 20 mm plastered with 1 : 3 cement sand mortar finished neat cement rendering.

Items	No.	L.	B.	Ht. or D.	Qty.
1. Earthwork in excavation	1	1.90	.95	.15	.27 cu m
2. Concrete in foundation	1	1.90	.95	.10	.18 cu m
3. Brickwork — 1st step	1	1.80	.90	.20	.324
2nd step	1	1.80	.60	.15	.162
3rd step	1	1.80	.30	.15	.081
<b>Total</b>					<b>0.567 cu m</b>

4. Finishing 20 mm cement plastered —

Treads	—	3	1.80	.30	—	1.62
Risers	—	4	1.80	—	.15	1.08
Ends	—	2	.90	—	.15	.27
	—	2	.60	—	.15	.18
	—	2	.30	—	.15	.09
Total						3.24 sq m

In the above estimate of step —

The quantities of brickwork may also be calculated in short as —

$$\text{Average sectional area} \times \text{length} = \left( \frac{.90 + .30}{2} \times .45 \right) \times 1.80 = .486$$

$$\text{Below ground level} = 1.80 \times .90 \times .05 = .081$$

$$\text{Total} = .486 + .081 = .567 \text{ cu m}$$

The quantities of plastering may be calculated in short as —

$$\text{Risers and treads} = \text{Length} \times \text{total of risers and treads}$$

$$= 1.80 \times (4 \times .15 + 3 \times .30) = 2.70$$

$$\text{Ends} = 2 \times \text{Average breadth} \times \text{height} = 2 \times \left( \frac{.90 + .30}{2} \right) \times .45 = .54$$

$$\text{Total} = 2.70 + .54 = 3.24 \text{ sq m}$$

Note. — If there are four steps (even number of steps) the quantities may be calculated in details step by step. By short method the quantities may be calculated as follows —

$$\text{Quantities of brickwork above G.L.} = \left( \frac{1.20 + .90 + .60 + .30}{4} \times .60 \right) \times 1.80 = .81 \text{ cu m}$$

Quantity of plastering —

$$\text{Risers and treads} = 1.80 (5 \times .15 + 4 \times .30) = 3.51$$

$$\text{Ends} = 2 \times \left( \frac{1.20 + .90 + .60 + .30}{4} \right) \times .60 = .90$$

$$\text{Total} = 3.51 + .90 = 4.41 \text{ sq m}$$

II. Estimate of three sides step given in Fig. 2-17.

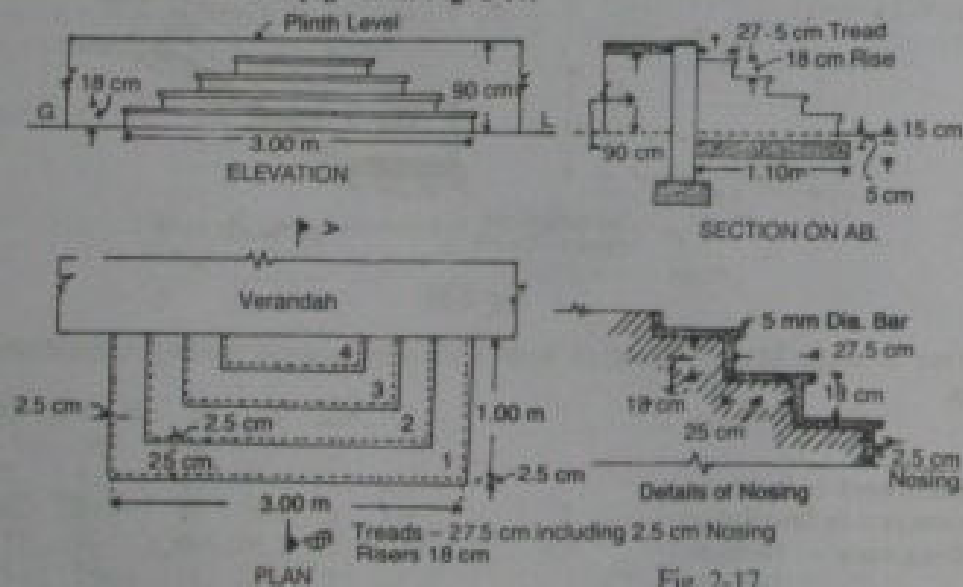

Fig. 2-17

Surface of steps is provided with 2.5 cm c.c. 1 : 1½ : 3 finished with neat cement.

Items	No.	L. m	B. m	Ht. or D. m	Qty.	
1. Earthwork in excavation	—	1	3.20	1.10	.20	.71 cu m
2. Concrete in foundation	—	1	3.20	1.10	.15	.53 cu m
3. Brickwork — 1st step	—	1	3.00	1.00	.23	.690
2nd step	—	1	2.50	.75	.18	.338
3rd step	—	1	2.00	.50	.18	.180
4th step	—	1	1.50	.25	.18	.068
Total					—	1.276 cu m
4. 2.5 cm c.c. 1 : 1½ : 3 in surface finishing —						
1st step — Tread, front and sides	—	1	4.50	.25	—	1.125
Risers, front and sides	—	1	5.00	—	.18	.900
2nd step — Tread, front and sides	—	1	3.50	.25	—	.875
Risers, front and sides	—	1	4.00	—	.18	.720
3rd step — Tread, front and sides	—	1	2.50	.25	—	.625
Risers, front and sides	—	1	3.00	—	.18	.540
4th step — Tread, front and sides	—	1	1.50	.25	—	.375
Risers, front and sides	—	1	2.00	—	.18	.360
Plinth — Riser	—	1	1.50	—	.18	.270
Total					—	5.790 sq m
5. 2.5 cm Nosing —						
1st step front and sides	—	1	5.00	—	—	5.00
2nd step front and sides	—	1	4.00	—	—	4.00
3rd step front and sides	—	1	3.00	—	—	3.00
4th step front and sides	—	1	2.00	—	—	2.00
Total					—	14.00 r m

ABSTRACT OF QUANTITIES

1. Earthwork in excavation	—	—	0.71	cu m
2. Concrete in foundation	—	—	0.53	cu m
3. Brickwork	—	—	1.276	cu m
4. 2.5 cm c.c. 1 : 1½ : 3 in surface finishing	—	—	5.79	sq m
5. 2.5 cm nosing	—	—	14.00	running metre.

III. Estimate of corner step given in Fig. 2-18.

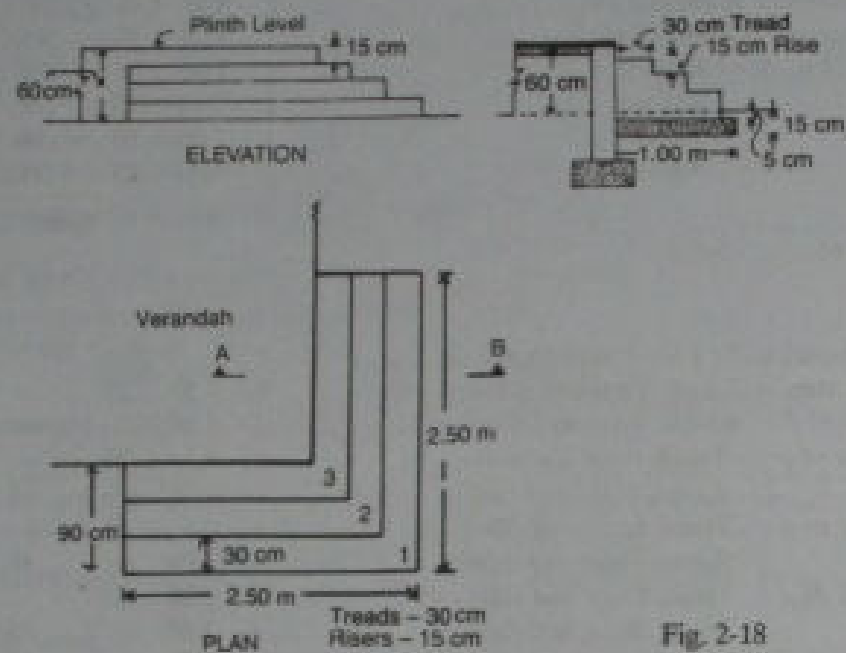

Fig. 2-18

Surface of steps with 20 mm cement plastered 1 : 3 with neat cement rendering.

Items	No.	L.	B.	Ht. or D.	Qty.	Explanatory note
		m	m	m		
1. Earthwork in excavations —						
Front	...	2.70	1.00	.20	.54	$L = 2.50 + .10 + .10 = 2.70 \text{ m}$
Side	...	1.70	1.00	.20	.34	$L = 2.50 - .90 + .10 = 1.70 \text{ m}$
					Total...	.88 cu m
2. Concrete in foundation —						
Front	...	2.70	1.00	.15	.405	Length same as above
Side	...	1.70	1.00	.15	.255	
					Total...	.66 cu m
3. Brickwork —						
1st step — Front	...	2.50	.90	.20	.450	
Side	...	1.60	.90	.15	.216	$L = 2.50 - .90 = 1.60 \text{ m}$
2nd step — Front	...	2.20	.60	.15	.198	$L = 2.50 - .30 = 2.20 \text{ m}$
Side	...	1.60	.60	.15	.144	$L = 2.20 - .60 = 1.60 \text{ m}$
3rd step — Front	...	1.90	.30	.15	.086	$L = 2.50 - .60 = 1.90 \text{ m}$
Side	...	1.60	.30	.15	.072	$L = 1.90 - .30 = 1.60 \text{ m}$
					Total...	1.166 cum

4. 20 mm cement plastering —

1st step — Tread, front and side	...	1	4.70	.30	—	1.41	$L = 2.50 + 2.20 = 4.70 \text{ m}$
Riser, front and side	...	1	5.00	—	.15	.75	
2nd step — Tread, front and side	...	1	4.10	.30	—	1.23	$L = 2.20 + 1.90 = 4.10 \text{ m}$
Riser, front and side	...	1	4.40	—	.15	.66	
3rd step — Tread, front and side	...	1	3.50	.30	—	1.05	$L = 1.90 + 1.60 = 3.50 \text{ m}$
Riser, front and side	...	1	3.80	—	.15	.57	
Plinth — Riser, front and side	...	1	3.20	—	.15	.48	
						Total...	6.15 sq. m

ABSTRACT OF QUANTITIES

1. Earthwork in excavation	—	—	0.88	cu m
2. Concrete in foundation	—	—	0.66	cu m
3. Brickwork	—	—	1.166	cu m
4. 20 mm cement plastering	—	—	6.15	sq. m

IV. Estimate of circular step as given in Fig. 2-19.

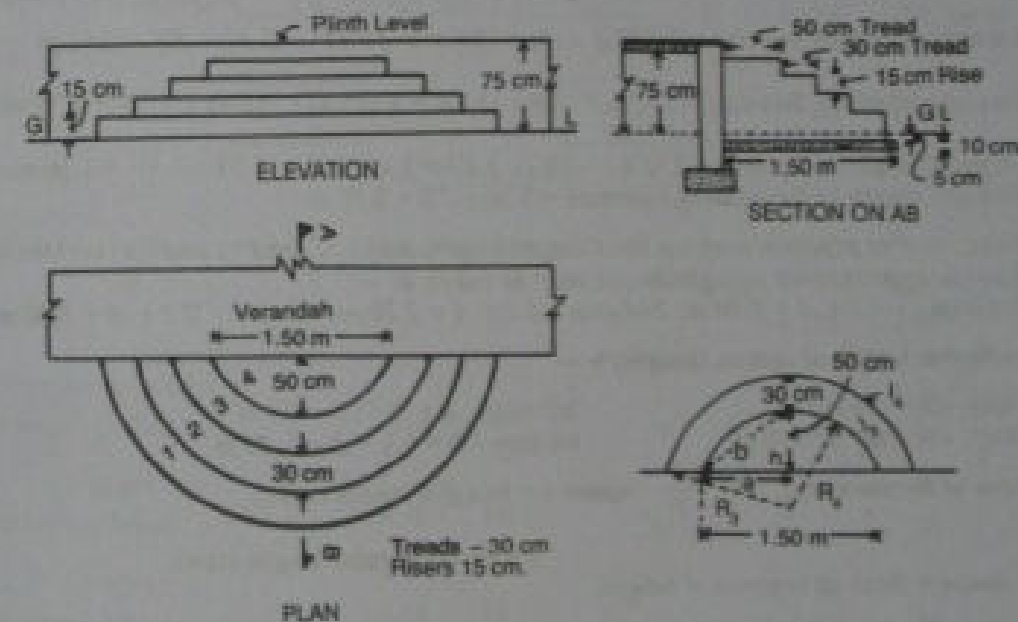

Fig. 2-19

Surface of step cement plastered 1 : 3 with neat cement finish.

Quantity of Earthwork, Concrete and Brickwork may be calculated by finding the area of the respective segment and multiplying the area by the height or depth.

For surface area, the area of tread may be calculated by finding the mean length of each tread (mean arc length) and multiplying by the breadth. The area of riser may be calculated by finding the outer length of each step (outer arc length) and multiplying by the height.

Figure 2-20 represents inverted position of 4th and 3rd step showing notations for easy understanding.

#### Radius of steps-R —

Radius of segment is given by  $R = \frac{h}{2} + \frac{s^2}{8h}$  where  $s$  = span or chord length, and

$h$  = rise or perpendicular length at centre.

$$\text{Radius of 4th step} - R_4 = \frac{.5}{2} + \frac{1.5^2}{8 \times .5} = .81 \text{ m}$$

$$\text{Radius of 3rd step} - R_3 = R_4 + .3 = .81 + .3 = 1.11 \text{ m}$$

$$\text{Radius of 2nd step} - R_2 = R_3 + .3 = 1.11 + .3 = 1.41 \text{ m}$$

$$\text{Radius of 1st step} - R_1 = R_2 + .3 = 1.41 + .3 = 1.71 \text{ m}$$

#### Straight length (span) of steps, S —

Straight length of 4th step = 1.50 m (given)

$$\text{Straight length of 3rd step} = 2 \sqrt{R_3^2 - (R_3 - .8)^2} = 2 \sqrt{1.11^2 - (1.11 - .8)^2} = 2.13 \text{ m}$$

$$\text{Straight length of 2nd step} = 2 \sqrt{R_2^2 - (R_2 - 1.1)^2} = 2 \sqrt{1.41^2 - (1.41 - 1.1)^2} = 2.75 \text{ m}$$

$$\text{Straight length of 1st step} = 2 \sqrt{R_1^2 - (R_1 - 1.4)^2} = 2 \sqrt{1.71^2 - (1.71 - 1.4)^2} = 3.36 \text{ m}$$

$$\text{Straight length of foundation concrete} = 3.36 + .20 = 3.56 \text{ m}$$

**Note.** — For practical purpose the straight lengths may be found by adding two treads i.e. 60 cm, thus the approximate straight length may be taken as —

3rd step —  $1.5 + .6 = 2.10 \text{ m}$ , 2nd step —  $2.1 + .6 = 2.70 \text{ m}$ , 1st step —  $2.7 + .6 = 3.30 \text{ m}$ .

#### Perpendicular length at centre, (height) h —

$$\text{4th step} - h = .50 \text{ m,}$$

$$\text{3rd step} - h = .5 + .3 = .80 \text{ m,}$$

$$\text{2nd step} - h = .8 + .3 = 1.10 \text{ m,}$$

$$\text{1st step} - h = 1.1 + .3 = 1.40 \text{ m,}$$

$$\text{Area of Segment} = \frac{2}{3} \left( sh + \frac{h^3}{2s} \right) \text{ where } s = \text{straight length (span)}$$

$h$  = perpendicular length (rise).

Volume = Area of segment  $\times$  height.

#### Curved length of step (arc length) —

$$\text{Curved length} = \frac{8b - 2a}{3} \text{, where } a = \text{half straight length, } b = \sqrt{a^2 + h^2} \text{ (See Fig. 2-20)}$$

$$\text{4th step} - a = \frac{1.5}{2} = .75, h = .5, b = \sqrt{.75^2 + .5^2} = .9$$

$$\text{Curved length } l_4 = \frac{8 \times .9 - 2 \times .75}{3} = 1.90 \text{ m}$$

$$\text{3rd step} - a = \frac{2.13}{2} = 1.065, h = .8, b = \sqrt{1.065^2 + .8^2} = 1.33 \text{ m}$$

$$\text{Curved length } l_3 = \frac{8 \times 1.33 - 2 \times 1.065}{3} = 2.84 \text{ m}$$

$$\text{2nd step} - a = \frac{2.75}{2} = 1.375, h = 1.10, b = \sqrt{1.375^2 + 1.1^2} = 1.76 \text{ m}$$

$$\text{Curved length } l_2 = \frac{8 \times 1.76 - 2 \times 1.375}{3} = 3.78 \text{ m}$$

$$\text{1st step} - a = \frac{3.36}{2} = 1.68, h = 1.40, b = \sqrt{1.68^2 + 1.4^2} = 2.186 \text{ m}$$

$$\text{Curved length } l_1 = \frac{8 \times 2.186 - 2 \times 1.68}{3} = 4.71 \text{ m}$$

Surface area of riser = Curved length  $\times$  height of riser.

Surface area of tread = Mean curved length  $\times$  breadth of tread.

Items	No.	L.	B.	Ht. or D.	Qty.
1. Earthwork in excavation	1	$\left\{ \left( \frac{2}{3} \times 3.56 \times 1.5 \right) + \frac{1.5^3}{2 \times 3.56} \right\}$		$\times .15$	.605 cu m
Area $\times$ depth = $\left( \frac{2}{3} sh + \frac{h^3}{2s} \right) \times$ depth					
2. Concrete in foundation	1	$\left\{ \left( \frac{2}{3} \times 3.56 \times 1.5 \right) + \frac{1.5^3}{2 \times 3.56} \right\}$		$\times .10$	.403 cu m
3. Bricks in step —					
1st step	1	$\left\{ \left( \frac{2}{3} \times 3.36 \times 1.4 \right) + \frac{1.4^3}{2 \times 3.36} \right\}$		$\times .20$	.708
2nd step	1	$\left\{ \left( \frac{2}{3} \times 2.75 \times 1.1 \right) + \frac{1.1^3}{2 \times 2.75} \right\}$		$\times .15$	.338
3rd step	1	$\left\{ \left( \frac{2}{3} \times 2.13 \times .8 \right) + \frac{.8^3}{2 \times 2.13} \right\}$		$\times .15$	.188
4th step	1	$\left\{ \left( \frac{2}{3} \times 1.5 \times .5 \right) + \frac{.5^3}{2 \times 1.5} \right\}$		$\times .15$	.081
4. 20 mm cement plaster 1 : 3 —					
1st step — Tread	1	$\frac{4.71 + 3.78}{2}$		$\times .30$	—
Riser	1	4.71		.15	.71
2nd step — Tread	1	$\frac{3.78 + 2.84}{2}$		$\times .30$	—
Riser	1	3.78		.15	.57
3rd step — Tread	1	$\frac{2.84 + 1.90}{2}$		$\times .30$	.15
Riser	1	1.90		.15	.29
4th step — Tread	1	$\left( \frac{2}{3} \times 1.5 \times .5 + \frac{.5^3}{2 \times 1.5} \right)$		—	.54
Riser	1	1.5		.15	.23
Total					5.31 sq m

CHAPTER 3  
ESTIMATE OF BUILDINGS

Detailed estimates of various types of buildings and works, starting from simple one have been dealt in this chapter. Both the methods, the *General Method* (Long wall and short wall method) and the *Centre line method*, have been adopted to illustrate the application of these methods. For clarification of the dimensions a column, *Explanatory notes*, has been added so that the beginners may not find any difficulty to understand. If the beginners go through these estimates, they will be able to prepare estimate of any type of building.

MASONRY PLATFORM

Example 1. — Estimate the cost of a masonry platform 6 m × 5 m from the given drawing Fig. 3-1 (see page 67) and specifications.

GENERAL SPECIFICATION : (1) Foundation — Lime Concrete, (2) Masonry — 1st class brickwork in lime mortar, (3) Flooring — 2.5 cm cement concrete over 7.5 cm lime concrete, over wall only 2.5 cm cement concrete, (4) Wall finishing — Outside walls are 12 mm cement plastered 1 : 6.

RATES. — Take local current rates.

Centre to Centre Length —

$$\text{Centre to centre length long wall} = 6.00 - 2 \times \frac{40}{2} = 5.60 \text{ m.}$$

$$\text{Centre to centre length short wall} = 5.00 - 2 \times \frac{40}{2} = 4.60 \text{ m.}$$

DETAILS OF MEASUREMENT AND CALCULATION OF QUANTITIES (Ex. 1)

Item No.	Particulars of item of work	No.	Dimensions in metre			Quantity or Contents	Total Quantity	Explanatory notes
			L.	B.	Ht. or D.			
1.	Earthwork in excavation in foundation —							
	Long walls ...	2	6.40 m	.80 m	.70 m	7.17		L = 5.60 + .80 = 6.40 m D = 4.60 - .80 = 3.80 m
	Short walls ...	2	3.80 m	.80 m	.70 m	4.25		
					Total	11.42 cu m		
2.	Earthwork in filling inside above G.L.	1	5.20 m	4.20 m	1.93 m	42.15	42.15 cu m	Ht. = 2.00 - .075 = 1.925 = 1.93 m
3.	Lime concrete in foundation							
	Long walls ...	2	6.40 m	.80 m	.20 m	2.05		} Length same as for excavation.
	Short walls ...	2	3.80 m	.80 m	.20 m	1.21		
					Total	3.26 cu m		

MASONRY PLATFORM

Item No.	Particulars of item of work	No.	Dimensions in metre			Quantity or Contents	Total Quantity	Explanatory notes
			L.	B.	Ht. or D.			
4.	First class brickwork in lime mortar—							
	Long walls—							
	1st footing ...	2	6.20 m	.60 m	.20 m	1.49		L = 5.60 + .60 = 6.20 m
	2nd footing ...	2	6.10 m	.50 m	.10 m	0.61		L = 6.20 - .10 = 6.10 m
	Wall above footing	2	6.00 m	.40 m	2.20 m	10.56		L = 6.10 - .10 = 6.00 m
	Short walls —							
	1st footing ...	2	4.00 m	.60 m	.20 m	0.96		L = 4.60 - .60 = 4.00 m
	2nd footing ...	2	4.10 m	.50 m	.10 m	0.41		L = 4.00 + .10 = 4.10 m
	Wall above footing	2	4.20 m	.40 m	2.20 m	7.39		L = 4.10 + .10 = 4.20 m
						Total	21.42 cu m	
5.	12 mm cement sand plastering 1 : 6 in walls outside							
	Long walls ...	2	6.00 m	—	2.10 m	25.20		} Including 10 cm below G.L.
	Short walls ...	2	5.00 m	—	2.10 m	21.00		
					Total	46.20 sq m		
6.	2.5 cm c.c. 1:2:4 floor over and including 7.5 cm L.C.	1	5.20 m	4.20 m	—	21.84	21.84 sq m	
7.	2.5 cm c.c. 1:2:4 floor on top of walls —							
	Long walls ...	2	6.00 m	.40 m	—	4.80		
	Short walls ...	2	4.20 m	.40 m	—	3.36		
					Total	8.16 sq m		



## Abstract of Estimated Cost (Ex. I)

Item No.	Particulars of items of work	Quantity	Unit	Rate		Amount
				Rs.	P.	
1.	Earthwork in excavation in foundation	11.42	cu m	350.00	% cu m	39.97
2.	Earthwork in filling	42.15	cu m	275.00	% cu m	115.91
3.	Lime concrete in foundation	3.26	cu m	220.00	cu m	717.20
4.	1st class brickwork in lime mortar	21.42	cu m	300.00	cu m	6426.00
5.	12 mm cement sand plastering 1 : 6	46.20	sq m	7.00	sq m	323.40
6.	2.5 cm cement concrete 1 : 2 : 4 floor over and including 7.5 cm lime concrete	21.84	sq m	18.65	sq m	407.32
7.	2.5 cm cement concrete 1 : 2 : 4 floor	8.16	sq m	18.00	sq m	146.88
Total						8176.68
Add 3% for Contingencies						245.30
Add 2% for Workcharged Establishment						163.52
Grand Total						8585.50

The quantities of Item Nos. 1, 3 and 4 of the above example (Ex. I) can be found in simpler and quicker way by centre line method as given below :-

The length of centre lines of all walls —

Long walls —  $2 \times 5.60 = 11.20$

Short walls —  $2 \times 4.60 = 9.20$

Total ... 20.40 m

	No.	L.	B.	Ht. or D.	Qty.	Total Qty.
1. Earthwork in excavation	1	20.40 m	.80 m	.70 m	—	11.42 cu m
2. Lime concrete in foundation	1	20.40 m	.80 m	.20 m	—	3.26 cu m
3. 1st class brickwork in lime mortar						
1st footing	1	20.40 m	.60 m	.20 m	2.45	
2nd footing	1	20.40 m	.50 m	.10 m	1.02	
Wall above footing	1	20.40 m	.40 m	2.20 m	17.95	
					Total	21.42 cu m

It will be noticed that the dimensions in the length column remain same as walls are of same type and there are no junctions.

Other items may be calculated as usual.

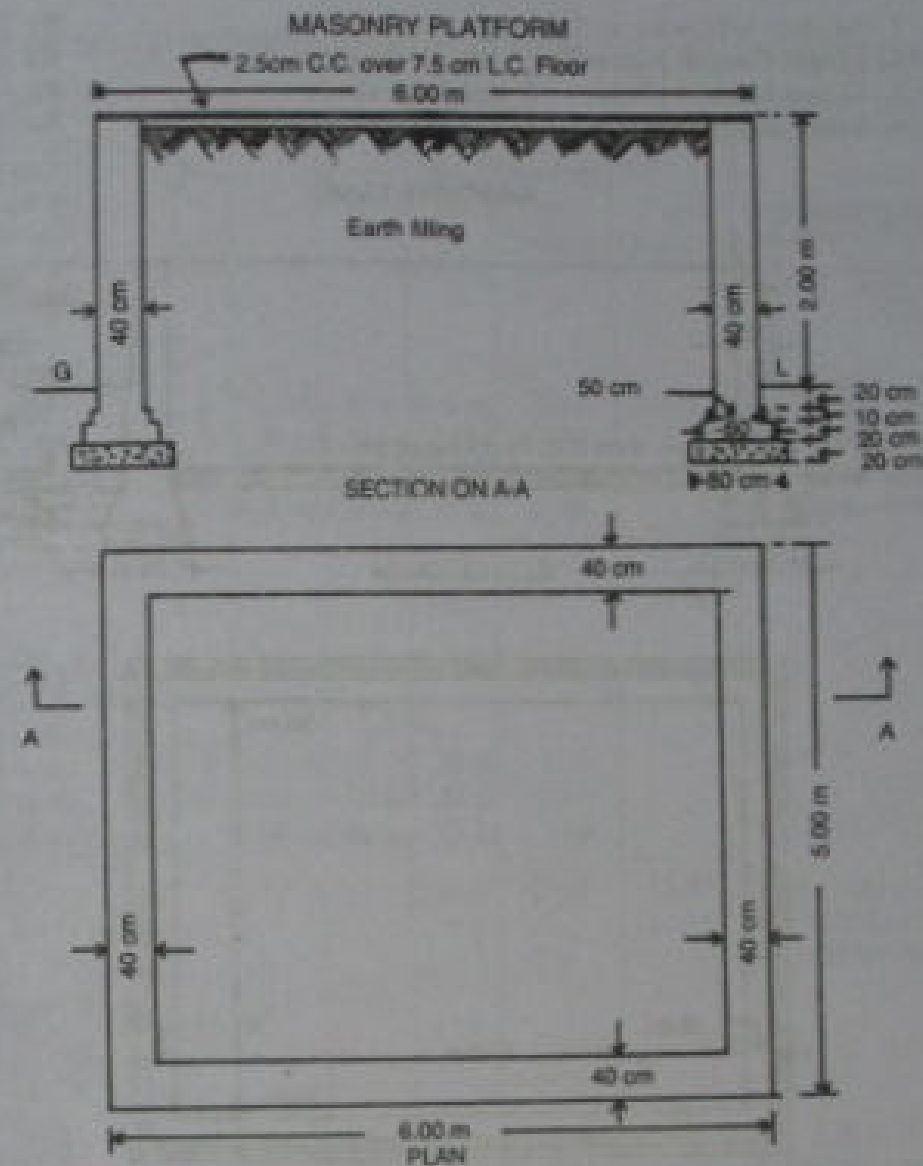

Fig. 3-1

## MASONRY WATER TANK

**Example 2.** — Estimate the cost of a masonry water tank from the given drawings (Fig. 3-2), specifications and rates.

**General Specifications.** — Foundation — Lime concrete. Masonry — 1st class brickwork in cement mortar 1 : 6. Wall finishing — Inside 12 mm cement plastered 1 : 2 with coarse sand. Top and outside 12 mm cement plastered 1 : 4 with local sand. Flooring — 5 cm cement concrete 1 : 1½ : 3 over 30 cm Lime concrete with neat cement finishing.

**Rates.** — 1. Earthwork in excavation — — — Rs. 350.00 per cu m  
2. Lime concrete in foundation and floor — — — Rs. 220.00 per cu m

3. 1st class brickwork in 1 : 6 cement mortar	---	Rs. 320.00 per cu m
4. 12 mm Cement plaster 1 : 2 with coarse sand	---	Rs. 8.50 per sq m
5. 12 mm Cement plaster 1 : 4 with local sand	---	Rs. 8.30 per sq m
6. 5 cm Cement concrete 1 : 1½ : 3 floor	---	Rs. 55.00 per sq m

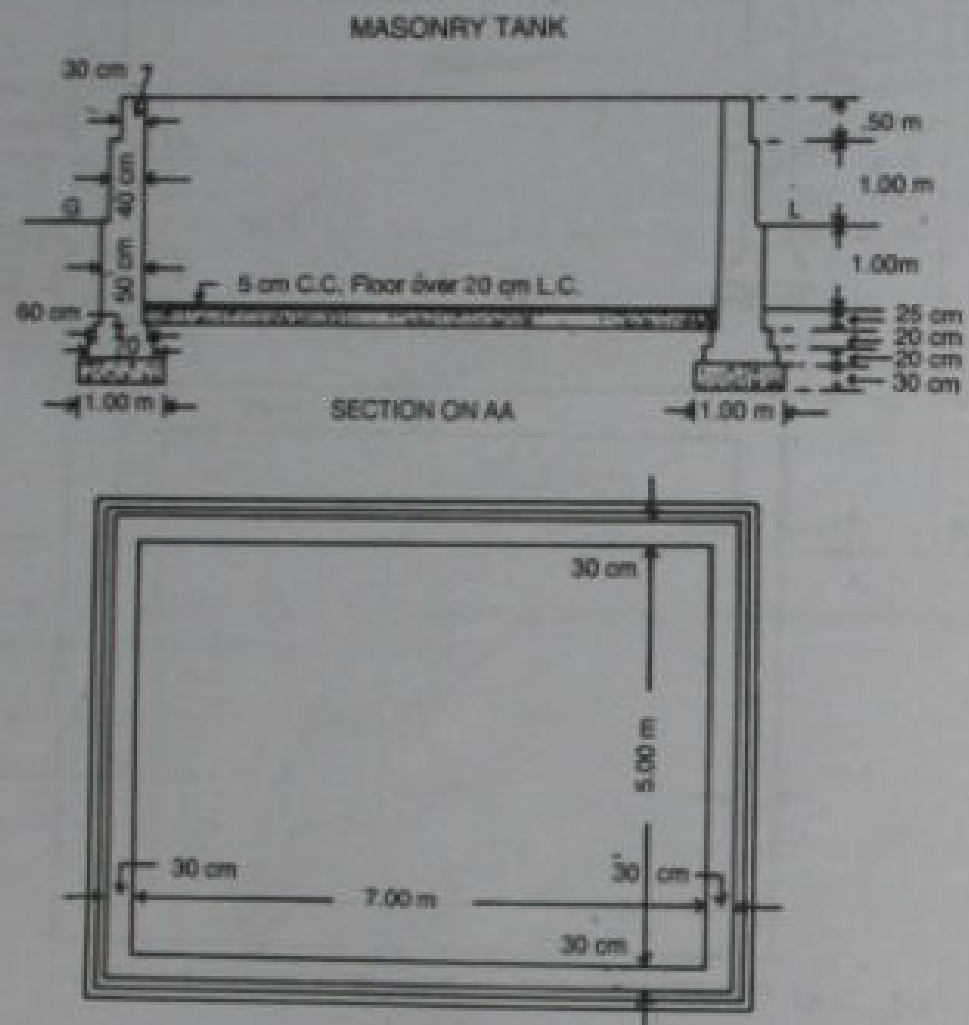

PLAN  
Fig. 3-2

#### Centre to Centre Lengths —

It may be noticed that the foundation footings are symmetrical below ground level, but above G.L. the footings are on one side only and unsymmetrical. The centre to centre distances for the portion below G.L. will be same, and for every step above G.L. the centre to centre distances will be different.

#### Portions below G.L. —

For all footings, c. to c. length of long wall = 7.50 m, and c. to c. length of short wall = 5.50 m.

#### Portions above G.L. —

For 40 cm wall, c. to c. length of long wall = 7.50 m, and c. to c. length of short wall = 5.40 m.

For 30 cm wall, c. to c. length of long wall = 7.30 m, and c. to c. length of short wall = 5.30 m.

#### DETAILS OF MEASUREMENT AND CALCULATION OF QUANTITIES (Ex. 2)

Item No.	Particulars of item of work	No.	Dimensions in metre			Quantity or Contents	Total Quantity	Explanatory notes
			L.	B.	Ht. or D.			
1.	Earthwork in excavation							
	Foundation							
	Long wall	2	8.50 m	1.00 m	1.95 m	33.15		L = 7.50 + 1.00 = 8.50 m
	Short wall	2	4.50 m	1.00 m	1.95 m	17.55		L = 5.50 - 1.00 = 4.50 m
	Central portion (inside)	1	6.50 m	4.50 m	1.25 m	36.56		L = 7.50 - 1.00 = 6.50 m B = 5.50 - 1.00 = 4.50 m
						Total	87.26 cu m	
2.	Lime concrete in foundation floor —							
	Foundation							
	Long walls	2	8.50 m	1.00 m	.30 m	5.10		
	Short walls	2	4.50 m	1.00 m	.30 m	2.70		
	Under c.c. floor	1	7.00 m	5.00 m	.20 m	7.00		
						Total	14.80 cu m	Floor lime concrete is not taken with c.c. floor as sufficiently thick.
3.	1st class brickwork in 1 : 6 cement mortar Below G.L.							
	Long wall							
	1st footing	2	8.20 m	.70 m	.20 m	2.29		L = 7.50 + .70 = 8.20 m
	2nd footing	2	8.10 m	.60 m	.20 m	1.94		L = 8.20 - .10 = 8.10 m
	50 cm wall	2	8.00 m	.50 m	1.25 m	10.00		L = 8.10 - .10 = 8.00 m
	Short wall							
	1st footing	2	4.80 m	.70 m	.20 m	1.34		L = 5.50 - .70 = 4.80 m
	2nd footing	2	4.90 m	.60 m	.20 m	1.18		L = 4.80 + .10 = 4.90 m
	50 cm wall	2	5.00 m	.50 m	1.25 m	6.25		L = 4.90 + .10 = 5.00 m
	Above G.L. —							
	40 cm long wall	2	7.80 m	.40 m	1.00 m	6.24		L = 7.40 + .40 = 7.80 m
	40 cm short wall	2	5.00 m	.40 m	1.00 m	4.00		L = 5.40 - .40 = 5.00 m
	30 cm long wall	2	7.60 m	.30 m	.50 m	2.28		L = 7.30 + .30 = 7.60 m
	30 cm short wall	2	5.00 m	.30 m	.50 m	1.50		L = 5.30 - .30 = 5.00 m
						Total	37.02 cu m	

Item No.	Particulars of item of work	No.	Dimensions in metre			Quantity or Contents	Total Quantity	Explanatory notes
			L.	B.	Ht. or D.			
4.	12 mm Cement plaster 1 : 2 with coarse sand inside							Length may be taken as inner perimeter in one operation — $Q = 24.00 \times 2.50 = 60.00 \text{ sq m}$
	Long walls	2	7.00 m	—	2.50 m	35.00		
	Short walls	2	5.00 m	—	2.50 m	25.00		
						Total	60.00 sq m	
5.	12 mm Cement plaster 1 : 4 with local sand outside— 40 cm walls —							Height including 10 cm offset and 15 cm below G.L.
	Long walls	2	7.80 m	—	1.25 m	19.50		
	Short walls	2	5.80 m	—	1.25 m	14.50		
	30 cm wall —							
	Long walls	2	7.60 m	—	.60 m	9.12		
	Short walls	2	5.60 m	—	.60 m	6.72		
	On top of wall—							
	Long walls	2	7.60 m	.30 m	—	4.56		
Short walls	2	5.00 m	.30 m	—	3.00			
					Total	57.40 sq m		
6.	5 cm cement concrete floor 1 : 1½ : 3	1	7.00 m	5.00 m	—	35.00	35.00 sq m	

## ABSTRACT OF ESTIMATED COST (Ex. 2)

Item No.	Particulars of Items	Qty.	Unit	Rate Rs.	Per	Rs.
1.	Earthwork in excavation	87.26	cu m	350.00	% cu m	305.40
2.	Lime concrete in foundation & floor	14.80	cu m	220.00	cu m	3256.00
3.	1st class Brickwork in 1 : 6 cement mortar	37.02	cu m	320.00	cu m	11846.40
4.	12 mm Cement plastering 1 : 2 with coarse sand	60.00	sq m	8.50	sq m	510.00
5.	12 mm Cement plastering 1 : 4 with local sand	57.40	sq m	8.30	sq m	476.42
6.	5 cm Cement concrete 1 : 1½ : 3 floor	35.00	sq m	55.00	sq m	1925.00
				Total		18319.22
	Add 3% for Contingencies					549.58
	Add 2% for Workcharged Establishment					366.38
	<b>Grand Total</b>					<b>19235.18</b>

The quantities of Earthwork in excavation in foundation, Lime concrete in foundation and Brickwork in Example 2 can be found in a simpler and quicker manner by centre line method as follows:

Total centre length for portion below G.L. =  $2(7.50 + 5.50) = 26.00 \text{ m}$

Total centre length for 40 cm wall above G.L. =  $2(7.40 + 5.40) = 25.60 \text{ m}$

Total centre length for 30 cm wall =  $2(7.30 + 5.30) = 25.20 \text{ m}$

	No.	L. m.	B. m.	Ht. or D. m.	Qty.	Total Qty.
1. Earthwork in excavation in foundation	—	1	26.00	1.00	1.95	— 50.70 cu m
2. Lime concrete in foundation	—	1	26.00	1.00	.30	— 7.80 cu m
3. 1st class brickwork in 1 : 6 cement mortar						
Below G.L. —						
1st footing	—	1	26.00	.70	.20	3.64
2nd footing	—	1	26.00	.60	.20	3.12
50 cm wall	—	1	26.00	.50	1.25	16.25
Above G.L. —						
40 cm wall	—	1	25.60	.40	1.00	10.24
30 cm wall	—	1	25.20	.30	.50	3.78
					Total	37.03 cu m

Remaining portion may be found as usual

**Example 3.** — Prepare a detailed estimate of a motor garage from the given drawings, plan and section (Fig. 3-3). Adopt suitable rates. General Specifications are as follows:—

**Foundation and Plinth** — First class brickwork in 1 : 6 cement sand mortar over lime concrete. 2 cm damp proof course at the plinth level.

**Superstructure.** — Wall shall be of first class brickwork in lime mortar. Roof shall be of lime concrete terracing over R.C.C. slab. Window chowkhat shall be of sal wood, and shutters shall be 4 cm thick battens of shisham wood. Gate will be of 20 B.W.G. sheet iron in angle iron frame.

**Finishing.** — Floor of garage room shall be 2.5 cm c.c. over 7.5 cm L.C. and floor of approach ramp shall be of 4 cm c.c. over 7.5 cm L.C. Walls shall be 12 mm plastered with 1 : 6 cement local sand mortar. Ceiling and the exposed surfaces of outer projections of slab shall be 6 mm cement plastered with 1 : 3 cement coarse sand mortar. Inside and outside shall be white washed three coats. Windows and gate shall be painted two coats over one coat of priming.

Calculate also the plinth area rate of the garage.

### MOTOR GARAGE

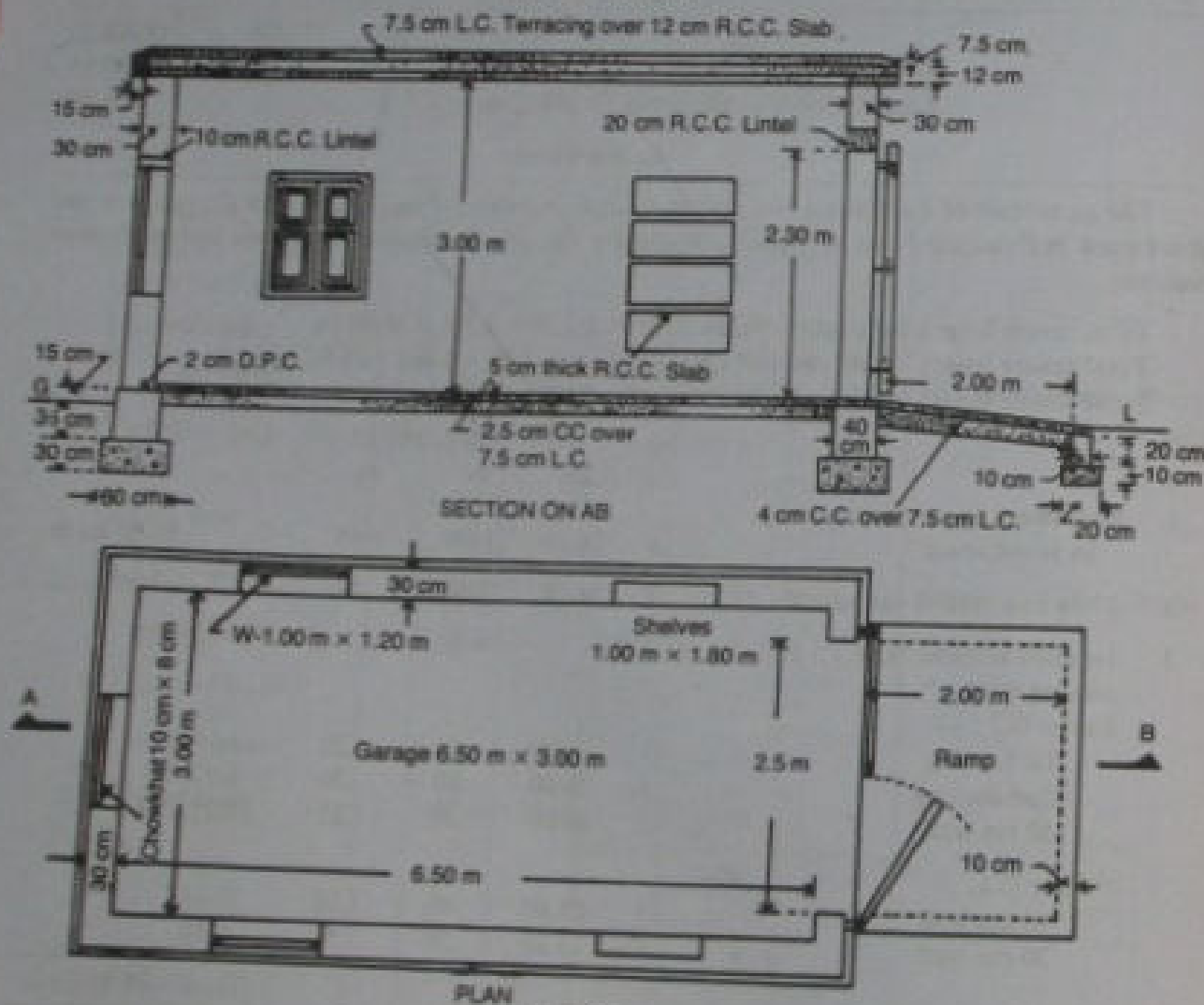

Fig. 3-3

Motor Garage — Long wall c. to c. length =  $6.50 + 0.30 = 6.80$  m, and short wall c. to c. length =  $3.00 + 0.30 = 3.30$  m.

Approach Ramp — Front wall c. to c. length =  $2.50 + 0.10 = 2.60$  m, and side walls c. to c. length =  $2.00 + .20 + .05 = 2.25$  m.

### MOTOR GARAGE

### DETAILS OF MEASUREMENT AND CALCULATION OF QUANTITIES (Motor Garage Ex. 3)

Item No.	Particulars of Items and details of work	No.	Dimensions in metre			Quantity or Content	Explanatory note
			Length	Breadth	Height or Depth		
1.	<b>Earthwork —</b>						
	In excavation in foundation —						
	Garage —						
	Long walls	2	7.40 m	0.60 m	0.65 m	5.77	$L = 6.80 + .60 = 7.40$ m
	Short walls	2	2.70 m	0.60 m	0.65 m	2.11	$L = 3.30 - .60 = 2.70$ m
	In filling in-plinth (Ht.) = $15\text{cm} - 7.5\text{cm} = 7.5$ cm	1	6.40 m	2.90 m	0.075 m	1.39	$L = 6.50 - .10 = 6.40$ m $B = 3.00 - .10 = 2.90$ m
	Approach Ramp						
	Excavation front wall	1	2.80 m	0.20 m	0.34 m	0.19	$L = 2.60 + .20 = 2.80$ m
	Excavation side wall	2	1.85 m	0.20 m	0.34 m	0.25	$L = 2.25 - \frac{.20}{2} - \frac{.60}{2} = 1.85$ m
						Total	9.71 cu m
2.	<b>Lime concrete in foundation</b>						
	Garage —						
	Long walls	2	7.40 m	0.60 m	0.30 m	2.664	} Half of earthwork in excavation.
	Short walls	2	2.70 m	0.60 m	0.30 m	0.972	
	Ramp —						
	Front walls	1	2.80 m	0.20 m	0.10 m	0.056	L same as excavation.
	Side walls	2	1.95 m	0.20 m	0.10 m	0.078	$L = 2.25 - \frac{.20}{2} - \frac{.40}{2} = 1.95$ m
					Total	3.77 cu m	
3.	<b>I-class brick-work in foundation and plinth with 1 : 6 cement sand mortar</b>						
	Garage —						
	Long walls	2	7.20 m	0.40 m	0.50 m	2.88	$L = 6.80 + .40 = 7.20$ m
	Short walls	2	2.90 m	0.40 m	0.50 m	1.16	$L = 3.30 - .40 = 2.90$ m
	Ramp —						
	Front walls	1	2.70 m	0.10 m	0.20 m	0.05	$L = 2.60 + .10 = 2.70$ m
	Side walls	2	2.00 m	0.10 m	0.20 m	0.08	$L = 2.25 - \frac{.10}{2} - \frac{.40}{2} = 2.00$ m
					Total	4.17 cu m	

Item No.	Particulars of items and details of work	No.	Dimensions in metre			Quantity or Content	Explanatory note
			Length	Breadth	Height or Depth		
4.	2 cm thick damp proof course—						
	Long walls	2	7.20 m	0.40 m	—	5.76	} Length same as item (3).
	Short walls	2	2.90 m	0.40 m	—	2.32	
					Total	8.08	
Deduct sill of gate	1	2.50 m	0.40 m	—	1.00		
			Net	Total	7.08	sq m	
5.	1-class brickwork in superstructure in lime mortar						
	Long walls 30 cm width	2	7.10 m	0.30 m	3.00 m	12.78	$L = 6.80 + .30 = 7.10 \text{ m}$
	Short walls 30 cm width	2	3.00 m	0.30 m	3.00 m	5.40	$L = 3.30 - .30 = 3.00 \text{ m}$
					Total	18.18	cu m
	Deduct —						
	Gate opening	1	2.50 m	0.30 m	2.30 m	1.725	
	Window opening	3	1.00 m	0.30 m	1.20 m	1.08	
	Shelf opening	2	1.00 m	0.20 m	1.80 m	0.72	$B = 20 \text{ cm}$
	Lintel over gate	1	2.90 m	0.30 m	0.20 m	0.174 (a)	Bearing 20 cm
	Lintel over window	3	1.20 m	0.30 m	0.10 m	0.108 (a)	Bearing 10 cm
Lintel over shelves	2	1.20 m	0.30 m	0.10 m	0.072 (a)	Bearing 10 cm	
		Total of deduction			3.879	Total of (a) = 0.354	
		Net		Total	14.301	= 14.30	
					cu m		
6.	R.C.C. 1 : 2 : 4 work excluding steel and its bending but including centering and shuttering and binding steel—						
	Roof slab	1	7.40 m	3.90 m	0.12 m	3.463	Steel bars are taken separately under item no 14.
	Lintels over gate, window and shelves		Same as marked in item 5	(a)		0.354	
	Slab of shelves 20 cm width	2 × 3	1.10 m	0.20 m	0.05 m	0.066	Bearing 5 cm
				Total	3.883	cu m	

Item No.	Particulars of items and details of work	No.	Dimensions in metre			Quantity or Content	Explanatory note
			Length	Breadth	Height or Depth		
7.	7.5 cm lime concrete in roof terracing including finishing surface	1	7.40 m	3.90 m	—	28.86	
						sq m	
8.	12 mm plaster cement sand 1 : 6 in wall— Inside —						
	Long walls	2	6.50 m	—	3.00 m	39.00	
	Short walls	2	3.00 m	—	3.00 m	18.00	
	Jambs, sills, soffits of shelves 20 cm width	2	5.60 m	0.20 m	—	2.24	$L = 2 \times 1.80 + 2 \times 1.00 = 5.60 \text{ m}$
	Jambs of gate	2	—	0.30 m	2.30 m	1.38	
	Soffit of lintel of gate	1	2.50 m	0.30 m	—	0.75	
	Outside —						
	Long walls above plinth	2	7.10 m	—	3.00 m	42.60	
	Short wall	2	3.60 m	—	3.00 m	21.60	
	Long walls plinth	2	7.20 m	—	0.30 m	4.32	$L = 7.10 + .10 = 7.20$
Short walls plinth	1	3.70 m	—	0.30 m	1.11	$L = 3.60 + 1.0 = 3.70$	
Ramp front wall	1	2.70 m	—	0.10 m	0.27	10 cm below G.L.	
Ramp side walls	2	2.10 m	—	$\frac{.10 + .25}{2}$	0.74	Average height.	
				Total	132.01		
	Deduct —						
Window opening (one side)	2	1.00 m	—	1.20	2.40		
Gate opening (both sides)	2	2.50 m	—	2.30	11.50	Jambs taken separately.	
		Total of deduction			13.90		
		Net		Total	118.11	sq m	
9.	6 mm plaster with 1 : 3 Cement coarse sand mortar—						
Ceiling	1	6.50 m	3.00 m	—	19.50		



## ABSTRACT OF ESTIMATED COST (MOTOR GARAGE, Ex. 3)

Item No.	Particulars of Items of work	Quantity	Unit	Rate		Amount
				Rs.	P.	
1.	Earthwork in excavation and filling	9.71	cu m	350.00	% cu m	33.98
2.	Lime concrete in foundation with lime surkhi mortar	3.77	cu m	220.00	/ cu m	829.40
3.	I-class brickwork in foundation and plinth with 1 : 6 cement sand mortar	4.17	cu m	320.00	/ cu m	1334.40
4.	2 cm thick damp proof course (D.P.C.) of 1 : 2 cement coarse sand mortar with water proofing compound	7.08	sq m	18.00	/ sq m	127.44
5.	I-class brickwork in superstructure in lime mortar	14.30	cu m	320.00	/ cu m	4576.00
6.	R.C.C. 1 : 2 : 4 work excluding steel and its bending but including centering and shuttering and binding steel	3.883	cu m	675.00	/ cu m	2621.00
7.	7.5 cm Lime Concrete in roof terracing	28.86	sq m	9.00	/ sq m	259.74
8.	12 mm plaster of cement sand 1 : 6 in walls	118.11	sq m	7.10	/ sq m	838.58
9.	6 mm plaster with 1 : 3 cement coarse sand mortar in ceiling	25.60	sq m	5.30	/ sq m	135.68
10.	2.5 cm c.c. 1 : 2 : 4 floor over and including 7.5 cm lime concrete	20.38	sq m	18.65	/ sq m	380.10
11.	4 cm c.c. 1 : 2 : 4 floor over and including 7.5 cm lime concrete in ramp	5.67	sq m	22.00	/ sq m	124.74
12.	Wood work, sal wood in chowkhat	0.07	cu m	4700.00	/ cu m	329.00
13.	4 cm shutters battened of shisham wood including fitting	2.27	sq m	125.00	/ sq m	283.75
14.	Mild steel bar in R.C.C. work	3.048	quin-tal	515.00	/ quin-tal	1569.72
15.	Iron hold fasts	14.00	kg	7.00	/ kg	98.00
16.	Sheet iron gate of 20 B.W.G. sheet in angle iron frame	6.21	sq m	120.00	/ sq m	745.20
17.	White washing 3 coats	140.84	sq m	0.75	/ sq m	105.63
18.	Painting 2 coats over one coat of priming	17.82	sq m	10.40	/ sq m	185.33
				Total	--	14577.69
				Add 3% for Contingencies	--	437.33
				Add 2% for Workcharged Establishment	--	291.55
						15306.57

## Plinth Area Rate

Plinth area = 7.10 m × 3.60 m = 25.56 sq m.

$$\text{P.A. Rate} = \frac{\text{Plinth Area}}{\text{Total Cost}} = \frac{15306.57}{25.56} = \text{Rs. } 598.85 \text{ per sq m}$$

Note. — The quantities of earthwork in Excavation (item 1), L.C. in foundation (item 2), Brickwork in foundation and in superstructure (item 2 and 5) can be easily found by centre line method as follows :

## Centre line method (Ex. 3, Motor Garage) —

The quantities of Earthwork in excavation in foundation (item 1), Lime concrete in foundation (item 2), I-class brickwork in foundation and plinth (item 3), Damp proof course (item 4) and I-class brickwork in superstructure (item 5) may be calculated by centre line method as follows :—

## Garage —

Total length of centre lines of all walls of garage = 2 × 6.80 + 2 × 3.30 = 20.20 m

Item No.	Particulars of Items and details of work	No.	Length	Breadth	Height or Depth	Quantity or Content	Explanatory notes
1.	Earthwork in excavation in foundation	1	20.20 m	0.60 m	0.65 m	7.88 cu m	No junction, length same althrough.
2.	Lime concrete in foundation	1	20.20 m	0.60 m	0.30 m	3.64 cu m	
3.	I-class brick-work in foundation and plinth	1	20.20 m	0.40 m	0.50 m	4.04 cu m	
4.	2 cm thick damp proof course	1	20.20 m	0.40 m	—	8.08 cu m	
	Deduct sill of gate	1	2.50 m	0.40 m	—	1.00 cu m	
						Total	7.08 sq m
5.	I-class brick-work in super-structure	1	20.20 m	0.30 m	3.00 m	18.18 cu m	Details same as in page 3-74.
	Deduct openings and lintels as usual	—	—	—	—	3.88 cu m	
						Total	

## Ramp —

Total length of centre lines of all walls of the three sides of ramp, front and two sides = (2.50 + 10) + 2 (2.00 + .05 + 20) = 7.10. Numbers of junctions are two with main walls.

1.	Earthwork in excavation	1	6.50	0.20	0.34	0.44	cu m	$L = 7.10 - 2 \times \frac{60}{2} = 6.50 \text{ m}$
2.	Lime concrete in foundation	1	6.70	0.20	0.10	0.134	cu m	$L = 7.10 - 2 \times \frac{40}{2} = 6.70 \text{ m}$

3. Brickwork in foundation and plinth of ramp is to be calculated by the same method as in page 73-74, as the height of side wall is different from the front wall.

Example 4. — Prepare a detailed estimate of a single room building having a front verandah from the given plan, elevation and sectional drawings (Fig. 3-4). General specifications are as follows :—

**Foundation and plinth.** — First class brickwork in 1 : 6 cement and local sand mortar over lime concrete, 2 cm D.P.C. of 1 : 2 cement mortar mixed with standard water proofing material.

**Superstructure.** — Walls shall be of first class brickwork in lime mortar. Inside and outside walls shall be 12 mm plastered with 1 : 1 : 6 cement : lime : sand, ceiling shall be 12 mm 1 : 3 cement plastered. Inside shall be white washed three coats and outside shall be colour washed one coat over two coats of white washing.

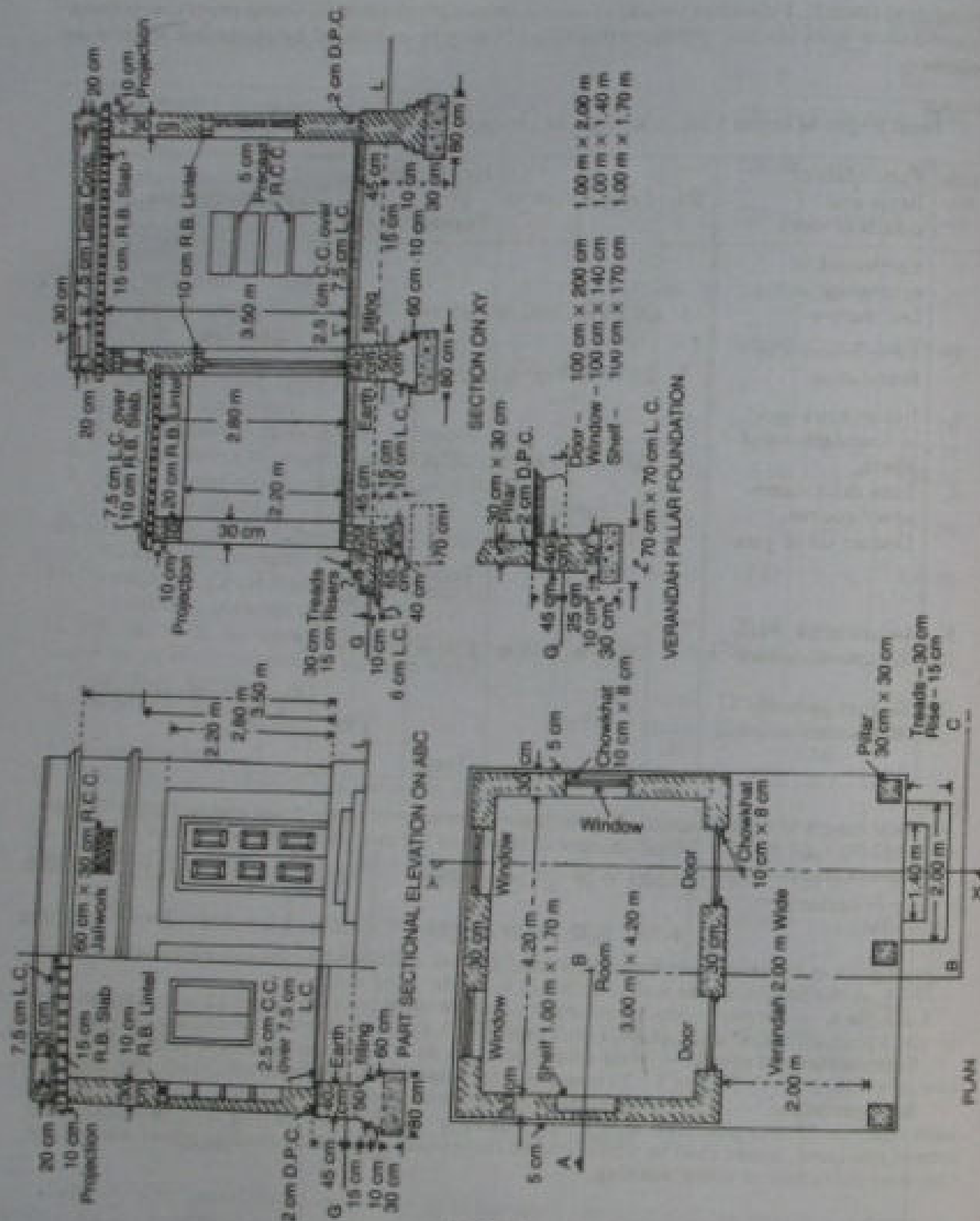

Fig 3-4

**Door and Windows.** — Door and window chowkhats shall be of sal wood and shutters shall be 4 cm panelled of deodar wood, and painted two coats over one coat of priming.

Adopt suitable rates. Calculate also the plinth area rate of the building.

**Solution—**

Centre to centre length of walls —

Long wall c. to c. length = 4.20 + .30 = 4.50 m

Short wall c. to c. length = 3.00 + .30 = 3.30 m

Verandah front c. to c. length = 4.20 + .30 = 4.50 m

Verandah side c. to c. length = 2.00 + .30 = 2.30 m

**DETAILS OF MEASUREMENT AND CALCULATION OF QUANTITIES**  
(SINGLE ROOM BUILDING EX. 4)

Item No.	Particulars and details of work	No.	Dimensions			Quantity or Content	Explanatory notes	
			Length m	Breadth m	Height or Depth m			
1.	<b>Earthwork in excavation in foundation—Room</b>							
	Long walls	2	5.30	.80	.65	5.51	$L = 4.50 + .80 = 5.30$ m	
	Short walls	2	2.50	.80	.65	2.60	$L = 3.30 - .80 = 2.50$ m	
	<b>Verandah —</b>							
	Pillars	3	.70	.70	.65	0.96		
	Plinth dwarf wall front (sum total length)	1	3.10	.40	.25	0.31	$L = 4.50 - 2 \times .70 = 3.10$ m	
	Plinth dwarf wall sides	2	1.55	.40	.25	0.31	$L = 2.30 - \frac{.80}{2} - \frac{.70}{2} = 1.55$ m	
	Step	1	2.10	.65	.10	0.14		
						<b>Total</b>	<b>9.83</b>	
	2.	<b>Earthwork in filling in Plinth—</b>						
Room		1	4.10	2.90	.375	4.46		
Verandah		1	4.50	2.10	.375	3.54	$L = 4.90 - .40 = 4.50$ m $B = 2.35 - .20 - .05 = 2.10$ m	
						<b>Total</b>	<b>8.00</b>	
<b>Deduct —</b>								
Projection central pillar	1	.40	.20	.375	0.03	These deductions may be neglected being small.		
Projection side pillar	2	.20	.20	.375	0.03			
					<b>Total</b>		<b>0.06</b>	
			<b>Net</b>	<b>Total</b>	<b>7.94</b>	<b>cu m</b>		



Item No.	Particulars of Items and details of work	No.	Dimensions			Quantity or Content	Explanatory notes
			Length m	Breadth m	Height or Depth m		
3.	Lime concrete in foundation—						
	Room—						
	Long walls	2	5.30	.80	.30	2.54	
	Short walls	2	2.50	.80	.30	1.20	
	Verandah						
	Pillars	3	.70	.70	.30	0.44	
	Dwarf wall front (sum total length)	1	3.70	.40	.10	0.15	$L = 4.50 - 2 \times .40 = 3.70 \text{ m}$
	Dwarf wall sides	2	1.85	.40	.10	0.15	$L = 2.30 - \frac{.50}{2} - \frac{.40}{2} = 1.85$
	Step	1	2.10	.65	.06	0.08	
					Total	4.56 cu m	
4.	First class Brickwork in Foundation and Plinth in lime mortar—						
	Room—						
	Long walls—						
	1st footing	2	5.10	.60	.10	0.61	$L = 4.50 + .60 = 5.10 \text{ m}$
	2nd footing	2	5.00	.50	.10	0.50	$L = 4.50 + .50 = 5.00 \text{ m}$
	Plinth wall above footing	2	4.90	.40	.60	2.35	$L = 4.50 + .40 = 4.90 \text{ m}$
	Short walls—						
	1st footing	2	2.70	.60	.10	0.32	$L = 3.30 - .60 = 2.70 \text{ m}$
	2nd footing	2	2.80	.50	.10	0.28	$L = 3.30 - .50 = 2.80 \text{ m}$
	Plinth wall	2	2.90	.40	.60	1.39	$L = 3.30 - .40 = 2.90 \text{ m}$
	Verandah—						
	Pillars footing	3	.50	.50	.10	0.075	
	Pillars Plinth	3	.40	.40	.70	0.336	
	Dwarf wall front (sum total length)	1	3.70	.20	.60	0.44	$L = 4.50 - 2 \times .40 = 3.70 \text{ m}$
	Dwarf wall sides	2	1.90	.20	.60	0.46	$L = 2.30 - .40 = 1.90 \text{ m}$
					C.O.	6.76	

(Ex. 4 Contd.)

Item No.	Particulars of Items and details of work	No.	Dimensions			Quantity or Content	Explanatory notes
			Length m	Breadth m	Height or Depth m		
	Step—				B.F.	6.76	
	1st step	1	2.00	.60	.19	0.23	
	2nd step	1	1.40	.30	.15	0.06	
					Total	7.05 cu m	
5.	2 cm D. P. C. of 1:2 cement mortar with water-proofing materials—						
	Long walls	2	4.90	.40	—	3.92	Length, breadth same as plinth wall.
	Short walls	2	2.90	.40	—	2.32	
	Verandah—						
	Pillars	3	.40	.40	—	0.48	
						6.72	
	Deduct door sills	2	1.00	.40	—	0.80	
					Total	5.92 sq m	
6.	I-class Brickwork in superstructure in lime mortar—						
	Room—						
	Long walls	2	4.80	.30	3.50	10.08	$L = 4.50 + .30 = 4.80 \text{ m}$
	Short walls	2	3.00	.30	3.50	6.30	$L = 3.30 - .30 = 3.00 \text{ m}$
	Verandah—						
	Pillars	3	.30	.30	2.20	0.59	
	Front above lintel	1	4.80	.30	.40	0.57	
	Sides above lintel	2	2.00	.30	.40	0.48	
	Parapet long walls	2	4.80	.20	.375	0.72	
	Parapet short walls	2	3.20	.20	.375	0.48	
					Total	19.22	
	Deduct—						
	Door openings	2	1.00	.30	2.00	1.20	
	Window openings	3	1.00	.30	1.40	1.26	
	Shelf	1	1.00	.20	1.70	0.34	
	Ventilators	2	.60	.30	.30	0.11	

Item No.	Particulars of items and details of work	No.	Dimensions			Quantity or Content	Explanatory notes
			Length m	Breadth m	Height or Depth m		
	Lintel over doors	2	1.20	.30	.10	0.07 (a)	10 cm bearing.
	Lintel over windows	3	1.20	.30	.10	0.11 (a)	
	Lintel over shelves	1	1.20	.30	.10	0.04 (a)	Total of (a) s = 0.24 cu m
	Lintel over ventilator	1	.80	.30	.10	0.02 (a)	
			Total of deduction			3.15	
7.	Reinforced Brick-work in 1:3 cement mortar excluding steel and its bending but including centering and shuttering and binding steel			Net	Total	16.07 cu m	
	Roof of room	1	5.00	3.80	.15	2.850	
	Roof of verandah	1	5.00	2.55	.10	1.275	15 cm bearing.
	Lintel verandah front	1	4.80	.30	.20	0.288	Out to out.
	Lintel verandah sides	2	2.15	.30	.20	0.258	15 cm bearing
	Lintel over doors, windows, etc		Same marked	as for (a) in items	item 6	0.240	
				Total		4.911 cu m	
8.	7.5 cm Lime concrete in roof terracing complete with surface finishing—						
	Roof of room	1	4.40	3.20	—	14.08	
	Roof of verandah	1	5.00	2.40	—	12.00	
				Total		26.08 cu m	
9.	Sal wood work in chowhat —						
	Doors (including 4 cm insertion into floor)	2	5.08	.10	.08	0.081	{ 2 Vert. — 2.04 m each 1 Hor. — 1.00 m each
	Windows	3	4.80	.10	.08	0.115	{ 2 Vert. — 1.40 m each 2 Hor. — 1.00 m each
				Total		0.196 cu m	

(Ex. 4 Contd.)

Item No.	Particulars of items and details of work	No.	Dimensions			Quantity or Content	Explanatory notes
			Length m	Breadth m	Height or Depth m		
10.	4 cm thick Panelled shutters of Deodar wood						
	Doors	2	0.87	1.935	—	3.367	15 cm rebate.
	Windows	3	0.87	1.27	—	3.315	
				Total		6.682 sq m	
11.	Iron fittings including screws and fixing for doors and windows	Same as for	item	(10)		6.68 sq m	
12.	Precast R. C. C. slab shelf complete work including steel reinforcement and form work	3	1.08	0.20	0.05	0.032 cu m	4 cm bearing.
13.	R. C. C. jali work 4 cm thick in ventilators complete work including steel reinforcement and form work	2	.60	.30	—	0.36 sqm	
14.	Mild steel in Reinforcement bars including bending in R.B. work (at 0.7% of item 7)		4.91 × 7	×	78.5 =	2.698 q	Density of mild steel = 78.5 q/cu m
	Hold fasts in doors and windows	24	@ 1 kg	each =	24 kg =	24 q	6 nos. in each door and 4 nos. in each window. (Hold fasts may be taken under separate item).
				Total		2.938 q	
15.	2.5 cm c. c. 1:2:4 floor over and including 7.5 cm lime concrete —						
	Room	1	4.20	3.00	—	12.60	$\left\{ \begin{array}{l} L = \text{Out to out} - 2 \text{ dwarf walls.} \\ = (4.2 + 2 \times .30 + 2 \times .05) \\ - 2 \times .20 = 4.50 \text{ m} \\ B = (2.0 + .30 + .05) - .20 \\ = 2.15 \text{ m} \end{array} \right.$
	Verandah	1	4.50	2.15	—	9.68	
				Total		22.28	

Item No.	Particulars of items and details of work	No.	Dimensions			Quantity or Content	Explanatory notes
			Length m	Breadth m	Height or Depth m		
16.	Deduct—Central pillars	1	.30	.15	—	0.045	L = 4.80 - 3 × .30 = 3.90 m
	Side pillars	2	.15	.15	—	0.045	
					Total	0.090	
	2.5 cm c. c. 1:2:4 floor (without lime concrete)—			Net	Total	22.19 sq m	
	Doors sills	2	1.00	.30	—	0.60	
17.	Sills of verandah opening—Front in between pillars	1	3.90	.20	—	0.78	L = 4.80 - 3 × .30 = 3.90 m
	Sides	2	2.00	.30	—	0.80	
				Total	2.18 sq m		
	12 mm Plastering in ceiling with 1:3 cement and coarse sand mortar—						
Room	Room	1	4.20	3.00	—	12.60	Total of inside plastering.
	Verandah	1	4.20	2.00	—	8.40	
				Total	21.00 sq m		
18.	12 mm Plastering in walls with 1:1:6 cement lime and local sand mortar						L = 1.00 × 2 + 1.70 × 2 = 5.40 m
	Inside—						
	Room—						
	Long walls	2	4.20	—	3.50	29.40	
	Short walls	2	3.00	—	3.50	21.00	
	Jamba, sill and soffit of shelf	1	5.40	.20	—	1.08	
	Verandah—						
Wall	1	4.20	—	2.80	11.76	3 faces of central pillar and 2 faces of each end pillars.	
Pillar inner face	7	.30	—	2.20	4.62		
				C.O.	67.86		

(Ex. 4 Contd.)

Item No.	Particulars of items and details of work	No.	Dimensions			Quantity or Content	Explanatory notes
			Length m	Breadth m	Height or Depth m		
	Verandah above pillars (inner face)				B.F.	67.86	
	front	1	4.20	—	.60	2.52	L = 4.80 - 3 × .30 = 3.90 m
	—Do— Sides	2	2.00	—	.60	2.40	
	Soffits of verandah lintels front	1	3.90	.30	—	1.17	
	Soffits of verandah lintel sides	2	2.00	.30	—	1.20	
	Vertical faces of inner wall below lintel	2	—	.30	2.20	1.32	
				Total	—	76.47	
	Deduct door openings	2	1.00	—	2.00	4.00	One surface to each.
				Net	Total	72.47 sq m	Total of inside plastering.
	Outside—						
	Room —						
	Back wall	1	4.80	—	3.50	16.80	Ht. = .45 + .05 + .10 = .60 m
	Side walls	2	3.60	—	3.50	25.20	
	Plinth including 10 cm below G. L. and 5 cm offset back	1	4.90	—	.60	2.94	Ht. = 3.50 - 2.975 = .525 m
	—Do— Sides	2	3.65	—	.60	4.38	
	Front wall above verandah roof	1	4.80	—	.525	2.52	Ht. = .15 + .10 = .25 m
	Roof projections front and back	2	5.00	—	.25	2.50	
	—Do— Sides	2	3.60	—	.25	1.80	One face of central pillar and two faces each of end pillars.
	Verandah pillar outer faces	5	0.30	—	2.20	3.30	
					C.O.	59.44	

Item No.	Particulars of items and details of work	No.	Dimensions			Quantity or Content	Explanatory notes
			Length m	Breadth m	Height or Depth m		
	Verandah above pillars (outer face) front	1	4.80	—	B.F. .60	59.44	
	—Do— Sides	2	2.30	—	.60	2.88	
	Verandah Plinth wall front	1	4.90	—	.55	2.76	
	—Do— Sides	2	2.35	—	.55	2.70	
	Parapet walls (all four walls)	1	16.00	—	.875	14.00	Step to be deducted.
					Total	84.37	Total centre length = $2 \times 4.60 + 2 \times 3.40$ = 16.00 m Ht. = .30 + .20 + .375 = .875 m
	Deduct— Window openings	3	1.00	—	1.40	4.20	One face of each.
	Ventilators	—	—	—	—	—	No deduction.
	Step	1	2.00	—	.55	1.10	
					Total	5.30	
			Net	Total		79.07 sq m	Total of outside plastering.
19.	20 mm cement plaster 1:3 in steps finished with neat cement —		Grand total and outside	of inside plastering =		72.47 +	79.07 = 151.54 sq m
	1st step —						
	Tread	1	2.60	.30	—	0.78	
	Rise	1	3.20	—	.15	0.48	
	2nd step—						
	Tread	1	1.40	.30	—	0.42	
	Rise	1	2.00	—	.15	0.30	
	Plinth wall	1	1.40	—	.15	0.21	
		2	0.30	—	.30	0.18	
					Total	2.37 sq m	

(Ex. 4 Contd.)

Item No.	Particulars of items and details of work	No.	Dimensions			Quantity or Content	Explanatory notes
			Length m	Breadth m	Height or Depth m		
20.	White washing 3 coats—						
	Inside wall	Same	as inside plaster in item (18)			72.47	
	Ceiling	Same	as ceiling plaster in item (17)			21.00	
					Total	93.47 sq m	
21.	Colour washing one coat over two coats of white washing	Same	as out side (18)	plaster		79.07	
	Deduct portion below G.L.	1	19.80	—	.10	1.98	L = outer perimeter minus step. = $(4.90 \times 2 + 6.00 \times 2) - 2.00 = 19.80$ m
					Total	77.09 sq m	
22.	Painting of doors and windows two coats over one coat of priming—						
	Doors	2	2 × 2 1/4	1.00	—	9.00	1% for one face.
	Windows	3	2 1/4	1.00	—	9.45	1% for one face.
					Total	18.45 sq m	
23.	Coal tarring two coats in back of Chowkhats —						
	Doors	2	5.08	.10	—	1.02	Length same as chowkhats in item 9.
	Windows	3	4.80	.10	—	1.44	
						2.46 sq m	

## ABSTRACT OF ESTIMATED COST (EX. 4)

Item No.	Particulars of items	Quantity	Unit	Rate		Per	Amount	
				Rs.	P.		Rs.	P.
1.	Earthwork in excavation in foundation	9.83	cu m	350.00		% cu m		34.40
2.	Earthwork in filling in plinth	7.94	cu m	275.00		% cu m		21.84
3.	Lime concrete in foundation	4.56	cu m	220.00		per cu m		1003.20
4.	1-class brickwork in foundation and plinth in lime mortar	7.05	cu m	300.00		per cu m		2115.00
5.	2 cm Damp proof course (D.P.C.) with 1:2 cement mortar and water proofing compound	5.92	sq m	18.00		per sq m		106.56
6.	1-class brickwork in superstructure in lime mortar	16.07	cu m	320.00		per cu m		5142.40
7.	Reinforced brickwork (R.B.) in 1:3 cement mortar excluding steel and its bending but including centering and shuttering and binding steel	4.91	cu m	675.00		per cu m		3314.25
8.	7.5 cm lime concrete in roof terracing	26.08	sq m	9.00		per sq m		234.72
9.	Sal wood work in chowkhat	0.196	cu m	4700.00		per cu m		921.20
10.	4 cm thick panelled shutters of Deodar wood excluding fittings	6.682	sq m	200.00		per sq m		1336.40
11.	Iron fitting in doors and windows	6.68	sq m	13.00		per sq m		86.84
12.	Precast R.C.C. Slab 1:2:4 in shelves including steel reinforcement	0.032	cu m	775.00		per cu m		24.80
13.	R.C.C. Jalli work 4 cm thick of 1:2:4 cement concrete including steel reinforcement	0.36	sq m	168.00		per sq m		60.48
14.	Mild steel including bending in reinforcement and hold fasts	2.938	q	515.00		per q		1513.07
15.	2.5 cm c.c. 1:2:4 floor over and including 7.5 cm lime concrete	22.19	sq m	18.65		per sq m		413.84
16.	2.5 cm c.c. 1:2:4 floor (without L.C.)	2.18	sq m	13.10		per sq m		28.56
17.	12 mm plastering in ceiling with 1:3 cement, coarse sand mortar	21.00	sq m	10.80		per sq m		226.80
						C.O.		16584.36

## SINGLE ROOM BUILDING WITH FRONT VERANDAH

Item No.	Particulars of item	Quantity	Unit	Rate		Per	Amount	
				Rs.	P.		Rs.	P.
18.	12 mm plastering in walls with 1:1:6 cement, lime and local sand mortar	151.54	sq m	2.90		per sq m		439.47
19.	20 mm cement coarse sand plaster 1:3 in steps finished with neat cement	2.37	sq m	15.00		per sq m		35.55
20.	White washing three coats inside	93.47	sq m	0.75		per sq m		70.10
21.	Colour washing one coat over one coat of white washing	77.09	sq m	0.82		per sq m		63.21
22.	Painting doors and windows two coats over one coat of priming	18.45	sq m	10.40		per sq m		191.88
23.	Coal tarring two coats in back of chowkhat	2.46	sq m	2.30		per sq m		5.65
						Total		17390.22
						Add 3% for Contingencies		521.70
						Add 2% for Workcharged Establishment		347.80
						Grand Total		18259.72

## Plinth Area Rate—

$$\text{Plinth Area} = 4.80 \text{ m} \times 5.90 = 28.32 \text{ sq m.}$$

$$\text{Plinth Area} = \frac{\text{Total Cost}}{\text{Plinth Area}} = \frac{\text{Rs. } 18259.72}{28.32 \text{ sq m}} = \text{Rs. } 644.76 \text{ per sq m.}$$

## Centre Line Method Single Room Building with Front Verandah (Ex. 4) —

By centre line method the quantities of the following items may be estimated in a quicker way—

Earthwork in excavation (item 1), Lime concrete in foundation (item 3), First class brickwork in foundation and plinth (item 4), Damp proof course (item 5), First class brickwork in superstructure (item 6).

$$\text{Total length of centre lines of walls of room} = 4.50 \times 2 + 3.30 \times 2 = 15.60 \text{ m.}$$

$$\text{Total length of centre lines of walls of verandah} = 4.5 + 2.30 \times 2 = 9.10 \text{ m.}$$

$$\text{Total length of centre lines of walls of parapet} = 4.60 \times 2 + 3.40 \times 2 = 16.00 \text{ m.}$$

(Centre line method Ex. 4)

Item No.	Particulars of items and details of works	No.	Length m	Breadth m	Height or Depth m	Quantity	Explanatory note
1.	Earthwork in excavation in foundation —						
	Rooms ...	1	15.60	.80	.65	8.11	No junctions. Same as previous $L = 9.10 - 3 \text{ pillars} - \frac{1}{2} \times 2$ junctions with main wall $= 9.10 - 3 \times .70 - \frac{1}{2} \times 2 \times .80 = 6.20$
	Verandah pillars ...	3	.70	.70	.65	0.96	
	Plinth dwarf wall ...	1	6.20	.40	.25	0.62	
Step ...	1	2.10	.65	.10	0.14		
					Total	9.83 cu m	
2.	Lime concrete in foundation						
	Room ...	1	15.60	.80	.30	3.74	$L = 9.10 - 3 \times .40 - \frac{1}{2} \times 2 \times .40 = 7.50 \text{ m}$
	Verandah Plinths ...	3	.70	.70	.30	0.44	
	Plinth dwarf wall ...	1	7.50	.40	.10	0.30	
Step ...	1	2.10	.65	.06	0.08		
					Total	4.56 cu m	
3.	1-class brick in foundation and plinth —						
	Room —						
	1st footing ...	1	15.60	.60	.10	0.93	$L = 9.10 - 3 \times .40 - \frac{1}{2} \times 2 \times .40 = 7.5 \text{ m}$
	2nd footing ...	1	15.60	.50	.10	0.78	
	Plinth wall ...	1	15.60	.40	.60	3.74	
	Ver. Pillars —						
	1st footing ...	3	.50	.50	.10	0.075	
	Plinth wall ...	3	.40	.40	.70	0.335	
	Verandah dwarf wall ...	1	7.50	.20	.60	0.90	
	Step— 1st step ...	1	2.00	.60	.19	0.23	
2nd step ...	1	1.40	.30	.15	0.06		
					Total	7.05 cu m	
4.	2 cm D.P.C. —						
	Room ...	1	15.60	.40	—	6.24	Same as previous
	Verandah pillars ...	3	.40	.40	—	.48	
					Total	6.72	
	Deduct door sills	2	1.00	.40	—	0.80	
					Total	5.92 sq m	
5.	1-class brick-work in super structure in lime mortar—						
	Room ...	1	15.60	.30	3.50	16.38	$L = 9.10 - \frac{1}{2} \times 2 \times .30 = 8.80 \text{ m}$
	Verandah (as solid) ...	1	8.80	.30	2.80	7.39	
	Parapet ...	1	16.00	.20	375	1.20	
					Total	24.97 cu m	

	No.	L m	B m	Ht. or D. m	Qty.	Explanatory notes
Deduct —						
Verandah opening sides ...	1	3.90	.30	2.20	2.57	$L = 4.80 - 1 \times .30 = 3.9 \text{ m}$
Verandah opening front ...	2	2.00	.30	2.20	2.64	
Verandah lintel front ...	1	4.80	.30	.20	0.29	
Verandah lintel sides ...	2	2.15	.30	.20	0.25	
Deductions of doors, windows, etc.					3.15	Same as in page 84.
					Total	8.90 cu m
					Net Total	16.07 cu m

## ESTIMATE OF A TWO-ROOM BUILDING WITH FRONT VERANDAH

**Example 5.** — Prepare a detailed estimate of a two roomed building with front verandah from the given drawings — plan, elevations, etc. (Figs. 3-5 and 3-6). Calculate also the Plinth Area Rate. The General Specifications are as follows:—

**Foundation and Plinth.** — 1st class brickwork in 1 : 6 cement mortar over lime concrete.

**Damp proof course (D.P.C.).** — 2 cm thick cement mortar 1 : 2 with 1.00 kg of composal per bag of cement.

**Superstructure.** — 1st class brickwork in lime mortar. All lintels shall be of R.B.

**Roof.** — Lime concrete terracing over R.C.C. slab with an insulation layer of sand and clay in between.

**Flooring.** — 2.5 cm thick c.c. 1 : 2 : 4 over 8 cm thick lime concrete, over well rammed earth, surface neat cement finished. Sills of doors and verandah opening shall have only 2.5 cm c.c. floor.

**Plastering and finishing.** — Inside and outside walls 12 mm thick plastered with 1 : 1 : 6 cement : lime : sand mortar. Steps 20 mm thick cement plastered 1 : 3 and neat cement finished. R.C.C. works in sun-shades and chujjas should be fair and smooth finished without any extra payment. Inside white washed three coats and outside colour washed two coats over one coat of white washing.

**Doors and windows.** — Chowkhat (frame) shall be of well seasoned sal wood. Shutters shall be 4 cm thick panelled of Indian teak wood. C.S. window shutters shall be 4 cm thick glazed. Door and windows shall be painted two coats over one coat of priming. Back of chowkhat shall be painted with two coats of solignum.

**Miscellaneous items.** — Windows shall be provided with 16 mm dia. mild steel bars. Necessary iron hold fasts shall be provided in doors and windows. 4 nos. rain water spouts of 10 cm dia. C.I. pipe 1 m long each shall be provided.

TWO-ROOM BUILDING WITH FRONT VERANDAH

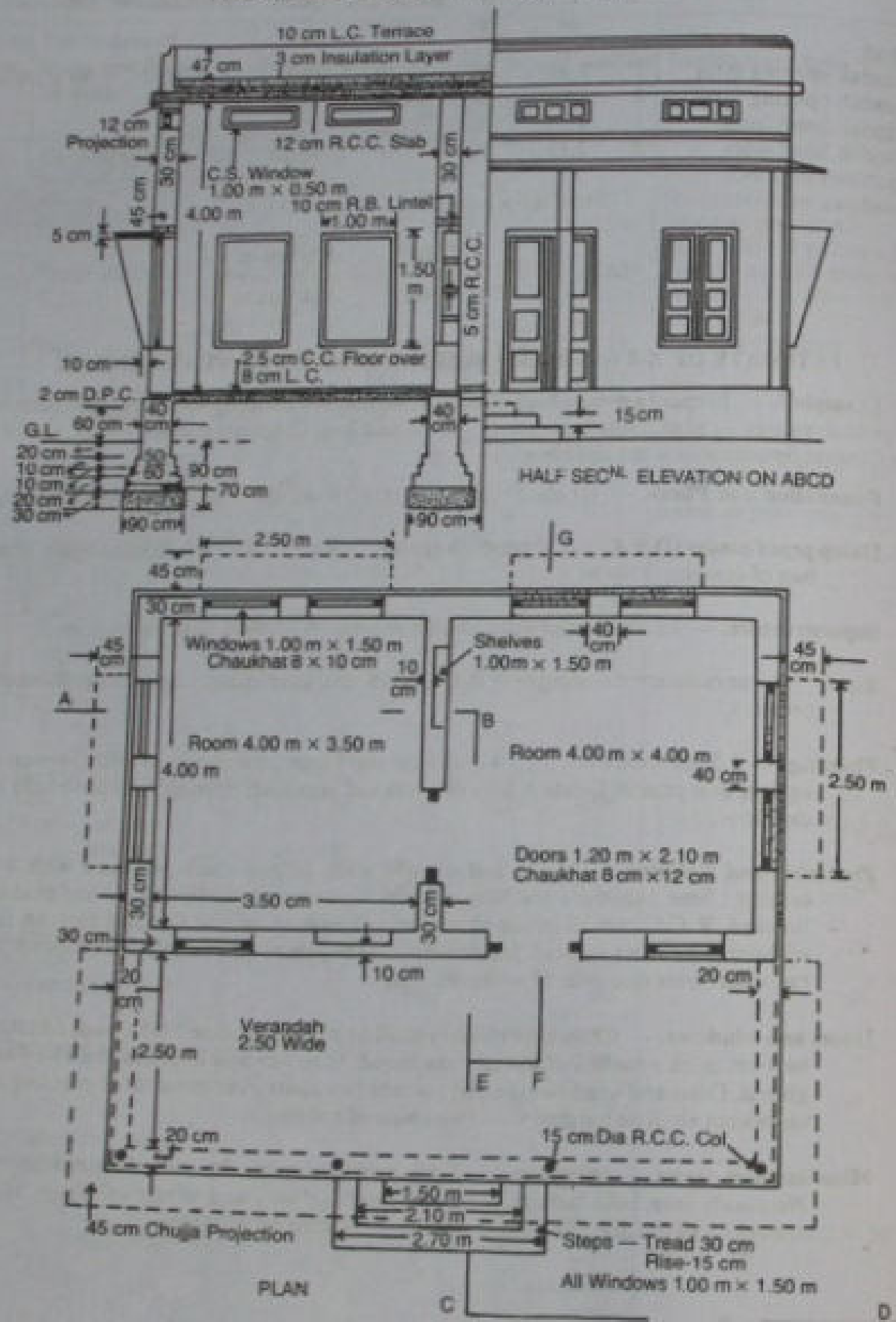
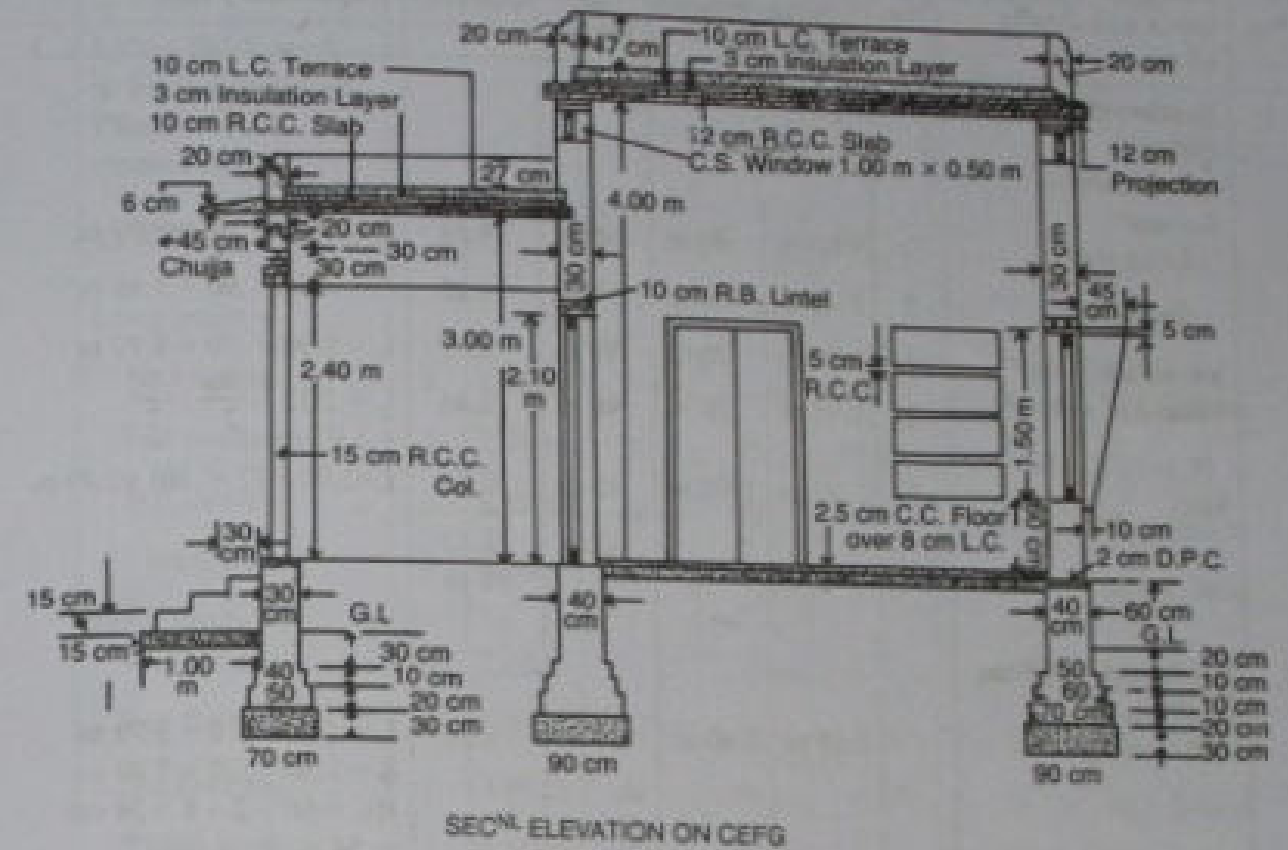

Fig. 3-5

TWO-ROOM BUILDING WITH FRONT VERANDAH

CROSS-SECTION OF TWO-ROOMED BUILDING



SECTION ELEVATION ON CEFG

Fig. 3-6

Note — Foundation of verandah is continuous of same section.

Centre to centre lengths —

Room Long walls —  $3.50 + 4.00 + 30 + (2 \times \frac{30}{2}) = 8.10$  m combined total length.

Room Short walls —  $4.00 + (2 \times \frac{30}{2}) = 4.30$  m

Verandah Front — Extreme outer length at plinth —  $(2 \times \frac{30}{2})$   
 $= \{ 3.50 + 4.00 + (3 \times 30) + (2 \times 05) \} - 30 = 8.20$  m

Verandah Sides —  $2.50 + \frac{30}{2} + \frac{20}{2} = 2.75$  m

## DETAILS OF MEASUREMENT AND CALCULATION OF QUANTITIES (Ex. 5)

Item No.	Particulars of items and details of works	No.	Length	Breadth	Height or Depth	Quantity	Explanatory note
1.	Earthwork in excavation in foundation—						
	Rooms						
	Long walls	2	9.00 m	.90 m	.90 m	14.58	$L = 8.10 + .90 = 9.00 \text{ m}$
	Short walls	3	3.40 m	.90 m	.90 m	8.26	$L = 4.30 - .90 = 3.40 \text{ m}$
	Verandah front	1	8.90 m	.70 m	.90 m	5.61	$L = 8.20 + .70 = 8.90 \text{ m}$
Verandah sides	2	1.95 m	.70 m	.90 m	2.46	$L = 2.75 - \frac{.90}{2} - \frac{.70}{2} = 1.95 \text{ m}$	
	Step	1	2.90 m	1.00 m	.15 m	0.44	$L = 2.70 + (2 \times .10) = 2.90 \text{ m}$
					Total	31.35 cu m	
2.	Earthwork in filling in plinth—						
	Room (i)	1	3.90 m	3.40 m	.54 m	7.16	$L = 4.00 - .10 = 3.90 \text{ m}$ $B = 3.50 - .10 = 3.40 \text{ m}$ $Ht. = 60 + 2 - 8 = 54 \text{ cm} = .54 \text{ m}$
	Room (ii)	1	3.90 m	3.90 m	.54 m	8.22	$L = 8.20 - .30 = 7.90 \text{ m}$ $B = 2.75 - \frac{.40}{2} - \frac{.30}{2} = 2.40 \text{ m}$
	Verandah	1	7.90 m	2.40 m	.54 m	10.23	
					Total	25.61 cu m	
3.	Lime concrete in foundation						
	Rooms —						
	Long walls	2	9.00 m	.90 m	.30 m	4.86	May be taken 1/3 of excavation.
	Short walls	3	3.40 m	.90 m	.30 m	2.75	
	Verandah front	1	8.90 m	.70 m	.30 m	1.87	
	Verandah sides	2	1.95 m	.70 m	.30 m	0.82	
Step	1	2.90 m	1.00 m	.15 m	0.44		
					Total	10.74 cu m	

(Ex. 5 Contd.)

Item No.	Particulars of items and details of works	No.	Length	Breadth	Height or Depth	Quantity	Explanatory note
4.	I-class Brick-work in Foundation and Plinth in 1 : 6 cement mortar—						
	ROOMS —						
	Long walls —						
	1st footing	2	8.80 m	.70 m	.20 m	2.46	$L = 8.10 + .70 = 8.80 \text{ m}$
	2nd footing	2	8.70 m	.60 m	.10 m	1.04	$L = 8.80 - .10 = 8.70 \text{ m}$
	3rd footing	2	8.60 m	.50 m	.10 m	0.86	$L = 8.70 - .10 = 8.60 \text{ m}$
	Plinth wall	2	8.50 m	.40 m	.80 m	5.44	$L = 8.60 - .10 = 8.50 \text{ m}$
	Short walls —						
	1st footing	3	3.60 m	.70 m	.20 m	1.51	$L = 4.30 - .70 = 3.60 \text{ m}$
	2nd footing	3	3.70 m	.60 m	.10 m	0.67	$L = 3.60 + .10 = 3.70 \text{ m}$
	3rd footing	3	3.80 m	.50 m	.10 m	0.57	$L = 3.70 + .10 = 3.80 \text{ m}$
	Plinth wall	3	3.90 m	.40 m	.80 m	3.74	$L = 3.80 + .10 = 3.90 \text{ m}$
	VERANDAH—						
	Front wall (long)—						
	1st footing	1	8.70 m	.50 m	.20 m	0.87	$L = 8.20 + .50 = 8.70 \text{ m}$
	2nd footing	1	8.60 m	.40 m	.10 m	0.34	$L = 8.70 - .10 = 8.60 \text{ m}$
	Plinth wall	1	8.50 m	.30 m	.90 m	2.30	$L = 8.60 - .10 = 8.50 \text{ m}$
	Side wall (short) —						
	1st footing	2	2.15 m	.50 m	.20 m	0.43	$L = 2.75 - \frac{.50}{2} - \frac{.70}{2} = 2.15 \text{ m}$
	2nd footing	2	2.25 m	.40 m	.10 m	0.18	$L = 2.75 - \frac{.40}{2} - \frac{.60}{2} = 2.25 \text{ m}$
						C.O.	20.41

Note. — Verandah wall foundation is continuous of same section for simplicity. In practice the foundation of verandah pillars should be square and separate and in between pillars there will be plinth dwarf wall of small section.





Item No.	Particulars of items and details of works	No.	Length m	Breadth m	Height or Depth m	Quantity	Explanatory notes
8.	R. C. C. work in ver. columns excluding steel and its bending, but including form work and binding steel complete fair finished	4	$\pi (.15)^2$ 4	x	2.70	= 0.19 cu m	30 cm insertion into the plinth wall below floor.
9.	R.C.C. work excluding steel and its bending, but including centering and shuttering and binding steel, fair finished—						
	Roof slab rooms	1	8.64	4.84	.12	5.018	12 cm projections.
	Roof slab ver.	1	8.40	2.80	.10	2.352	10 cm inner bearing, excluding chujja.
	Chujja projections						
	Ver. front	1	9.30	.45	.06	0.251	Average thickness.
	Ver. sides	2	2.70	.45	.06	0.146	
	Sun-shed and breakers in windows—						
	Top	4	2.50	.45	.05	0.225	
	Bottom	4	2.50	.15	.05	0.075	5 cm insertion into wall.
	Sides	4 x 2	1.50	.50 + .15	.05	0.195	5 cm insertion and average breadth.
	Shelf slab	2 x 3	1.10	.20	.05	0.066	5 cm bearing.
					Total	8.328 cu m	
10.	Mild steel bars including bending in reinforcement @ 1% of R.B. and R.C.C. works		10.31	$\times \frac{1}{100}$	78.5 =	8.10q	1% of total of items 1, 8 and 9.

Note. — Chujjas, sun sheds, etc. may be taken under a separate item.

(Ex. 5 Contd.)

Item No.	Particulars of items and details of works	No.	Length m	Breadth m	Height or Depth m	Quantity	Explanatory notes
11.	10 cm Lime concrete in roof terracing complete with surface finishing—						
	Rooms	1	8.00	4.20	—	33.60	Clear roof area in between parapet.
	Verandah	1	8.00	2.50	—	20.00	" " "
					Total	53.60 sq m	
12.	3 cm thick insulation layer of sand and clay—						
	Rooms	1	8.00	4.20	—	33.60	Clear roof area.
	Verandah	1	8.00	2.50	—	20.00	" "
					Total	53.60 sq m	
13.	Sal wood work in chowkhat wrought framed and fixed—						
	Doors (3 cm insertion into floor)	2	5.46	.12	.08	0.105	2 Vert.—2.13 m each. 1 Hor.—1.20 m each.
	Windows	10	5.00	.10	.08	0.400	2 Vert.—1.50 m each. 2 Hor.—1.00 m each.
	C.S. Windows	12	3.00	.08	.08	0.230	2 Vert.—0.50 m each. 2 Hor.—1.00 m each.
					Total	0.735 cu m	
14.	4 cm thick Indian teak wood panelled door and window shutters including fittings—						
	Doors	2	1.07	—	2.035	4.355	Rebate 1.5 cm.
	Windows	10	0.87	—	1.37	11.919	
					Total	16.274 sq m	
15.	4 cm thick Indian teak wood glazed shutters including fittings—						
	C.S. Windows	12	0.87	—	0.37	3.863 sq m	

Note— Lime concrete terracing (item 11) has been taken on area basis, if required the volume can be found by multiplying the thickness.

Door and window fittings may be taken under a separate item.

Item No.	Particulars of items and details of works	No.	Length m	Breadth m	Height or Depth m	Quantity	Explanatory notes
16.	Iron work (mild steel) in hold fasts and window gratings—						
	Hold fasts in doors	2×6	—	—	—	12 nos.	6 nos. per door.
	Hold fasts in windows	10×4	—	—	—	40 nos.	4 nos. per window.
	Hold fasts in C.S. windows	12×2	—	—	—	24 nos.	2 nos. per C.S. window.
						Total	76 nos. @ 1 kg each = 76 kg
	Window bars 16 mm dia. @ 1.58 kg/m—						
	Windows	10×8	1.50	—	—	120	Ver. bars at 10 cm centres approx.
	C.S. windows	12×2	1.00	—	—	24	Two horizontal bars.
						144 m	
						@ 1.58 kg	
						= 227.52 kg	
						Total	303.52 kg = 3.035 q
17.	12 mm thick plastering in walls 1 : 1 : 6 cement, sand, lime mortar —						
	INSIDE —						
	Rooms —						
	(i)	2	3.50	—	4.00	28.00	} May be taken as inner perimeter × ht. = 15.00 × 4.00
		2	4.00	—	4.00	32.00	
	(ii)	4	4.00	—	4.00	64.00	
	Verandah inner wall	1	8.40	—	3.00	25.20	Length out to out.
	Ver. Front above cols. inner face	1	8.00	—	.60	4.80	
	Ver. Sides above cols. inner face	2	2.50	—	.60	3.00	
	Jamba sills and soffits of shelves	2	5.00	.20	—	2.00	L=2 × 1.0 + 2 × 1.5=5.0 m
	Soffits of ver. lintel —						
	Front	1	8.40	.20	—	1.68	No deduction for col. ends.
	Sides	2	2.50	.20	—	1.00	
						Total	161.68

(Ex. 5 Contd.)

Item No.	Particulars of items and details of works	No.	Length m	Breadth m	Height or Depth m	Quantity	Explanatory notes
	Deduct openings in wall in between ver. and room —						
	Door openings	2	1.20	—	2.10	5.04	One surface of each.
	Window openings	2	1.00	—	1.50	3.00	
						Total	8.04
						Net	Total
							153.64 sq m
	OUTSIDE —						
	Rooms —						
	Back plinth including 10 cm below G.L.	1	8.50	—	.75	6.38	} Ht. = .60 + .05 = .10 = .75 m These can be combined as 1 × 8.40 × 4.75 = 39.90
	Back super-structure	1	8.40	—	4.00	33.60	
	Sides plinth including 10 cm below G.L.	2	4.70	—	.75	7.05	} These can be combined as 2 × 4.60 × 4.75 = 43.70
	Sides super-structure	2	4.60	—	4.00	36.80	
	Verandah —						
	Above cols. front outer face	1	8.40	—	.60	5.04	
	Above cols. sides outer face	2	2.70	—	.60	3.24	
	Plinth front including 10 cm below G.L.	1	8.50	—	.70	5.95	Ht. = .60 + .10 = .70 m
	Plinth sides	2	2.75	—	.70	3.85	
	Wall above ver. roof	1	8.40	—	.77	6.47	Ht. = 4.00 - 3.23 = .77 m
	Parapet —						
	Rooms —						
	Long wall outer face	2	8.40	—	.60	10.08	} These can be taken approx. in one operation as — = (total centre length + inner ht. + top width × outer ht.)
	Long wall inner face	2	8.00	—	.47	7.52	
	Long wall top face	2	8.40	.20	—	3.36	} = (2 × 8.40 + 2 × 4.20) × (.47 + .20 + (.47 + .10 + .03))
	Short walls outer face	2	4.60	—	.60	5.52	
	Short walls inner face	2	4.20	—	.47	3.95	
	Short walls top face	2	4.20	.20	—	1.68	× 25.20 × 1.27 = 32.00 sq m
						C.O.	140.49

Item No.	Particulars of items and details of works	No.	Length m	Breadth m	Height or Depth m	Quantity	Explanatory notes
					B.F.	140.49	
	Verandah parapet— Front wall outer face ...	1	8.40		.40	3.36	These can be taken approx. in one operation as — (Total centre length) × (inner ht. + top width × outer ht.) = (8.65 + 2 × 2.50) × [.27 + 20 + (.27 + .10 + .03)] = 13.65 × .87 = 11.88 sq m
	Front wall inner face ...	1	8.00		.27	2.16	
	Front wall top face ...	1	8.40	.20		1.68	
	Side wall outer face ...	2	2.70		.40	2.16	
	Side wall inner face ...	2	2.50		.27	1.35	
	Side wall top face ...	2	2.50	.20		1.00	
	Total					152.20	
	<b>Deduct —</b> Window openings (in outer walls) ...	8	1.00		1.50	12.00	One surface of each.
	C.S. window openings ...	12	1.00		0.50	6.00	One surface of each.
	Step from plinth wall ...	1	2.70		0.70	1.89	Including 10 cm below G.L.
	Ends of ver. side wall and lintel above col. level ...	2		.20	.60	0.24	This may be neglected.
	Ends of ver. parapet wall, from wall above ver. roof level ...	2		.20	.27	0.11	This may be neglected.
	Total of deductions					20.24	
	Net					131.96	Total of outside plastering.
	Grand outside				Total of inside plastering =	285.60	and sq m
18.	<b>20 mm thick cement plaster 1:3 in step finished cement rendered —</b> 1st step riser ...	1	4.50		.15	} = 1.49	Front and sides.
	2nd step riser ...	1	3.30		.15		Front and sides.
	3rd step riser ...	1	2.10		.15		Front and sides.

Note—No plastering in ceiling has been taken into account. R.C.C. work will be fair finished without any extra payment. If specified thin cement coarse sand plaster 1:3 may be provided and taken under a separate item.

(Ex. 5 Contd.)

Item No.	Particulars of items and details of works	No.	Length m	Breadth m	Height or Depth m	Quantity	Explanatory notes
	1st step tread ...	1	3.90		.30	} 2.43	Front and sides.
	2nd step tread ...	1	2.70		.30		Front and sides.
	3rd step tread ...	1	1.50		.30		Front and sides.
	Plinth wall above						
	1st step ...	2	.30		.45	0.27	Sides.
	2nd step ...	2	.30		.30	0.18	Sides.
	3rd step ...	1	1.50		.15	0.22	Sides.
	Total					4.59	sq m
19.	<b>2.5 cm thick c.c. 1:2:4 over and including 8 cm lime concrete floor—</b> Room (i) ...	1	4.00	3.50		14.00	
	Room (ii) ...	1	4.00	4.00		16.00	
	Verandah ...	1	8.00	2.50		20.00	Sills of verandah opening have been taken under item 20.
	Total					50.00	sq m
20.	<b>2.5 cm thick c.c. 1:2:4 floor in sills</b> Door sills ...	2	1.20	.30		0.72	
	Sills of ver. opening front ...	1	8.50	.25		2.12	Including .05 m plinth outer offset. No. deduction for cols.
	Sills of ver. opening sides ...	2	2.50	.25		1.25	
	Total					4.09	
	Deduct pillars ...	4	(.15)			0.07	This deduction may be neglected.
	Net					4.02	sqm

Item No.	Particulars of items and details of works	No.	Length m	Breadth m	Height or Depth m	Quantity	Explanatory notes	
21.	White washing three coats inside — Walls	Same as for plastering	inside in item	—	wall (17) =	153.64		
	Ceiling of room ...	1	4.00	3.50	—	14.00		
	Ceiling of room ...	1	4.00	4.00	—	16.00		
	Ceiling of ver. ...	1	8.00	2.50	—	20.00		
					Total	203.64 sq m		
22.	Colour washing two coats over one coat of white washing outside — Walls	Same as for plastering	outside in item	—	wall (17) =	131.96		
	Chujja ver. front	1	9.30	.95	—	8.84	Upper and lower faces and edges.	
	Chujja ver. sides	2	2.70	.95	—	5.13	Upper and lower faces and edges.	
	Sunshade and sun-breakers in windows — Top	4	2.50	.95	—	9.50	Upper and lower faces and edges.	
	Bottom	4	2.50	.25	—	2.50	.. .. .	
	Sides	8 × 2	1.50	$\frac{4.5 + .10}{2}$	—	6.60	Inner and outer faces.	
	Edges of sides	8	1.50	.05	—	0.60	This may be neglected.	
	Outer projection of roof slab	1	26.00	.36	—	9.36	L=Outer perimeter of room. B = .12 + .12 + .12 = .36 m	
						Total	174.49	
	Deduct portion below G.L.	1	29.10	—	.10	2.91	L=Outer perimeter—Steps = 2(8.50 + 7.40) - 2.70 = 29.10 m	
			Net	Total		171.58 sq m		

Note—Lower sides of chujjas and sunshades and inner faces of sun breakers may be white washed instead of colour washing.

Item No.	Particulars of items and details of works	No.	Length m	Breadth m	Height or Depth m	Quantity	Explanatory notes	
23.	Painting doors and windows two coats over one coat of priming—							
	Doors panelled ...	2 × 2¼	1.20	—	2.10	11.34	2¼ times one surface for both sides.	
	Windows panelled	10 × 2¼	1.00	—	1.50	33.75	.. .. .	
	C.S. windows glazed ...	12 × 1	1.00	—	0.50	6.00	One surface for both sides.	
	Window bars ...	10	0.84	1.34	—	11.25	} Excluding chowkhat, one flat area for over all.	
	C.S. window bars	12	0.84	0.34	—	3.43		
						Total	65.77 sqm	
	24.	Solignum painting two coats in back of chowkhat—						
		Doors ...	2	5.46	.12	—	1.31	} Lengths same for chowkhat in item (13)
		Windows ...	10	5.00	.10	—	5.00	
C.S. windows ...		12	3.00	0.08	—	2.88		
					Total	9.19 sq m		
25.	C.I. Pipe 10 cm dia. (rain water spout) complete with painting ...	4	1.00	—	—	4.00		

## ABSTRACT OF ESTIMATED COST (Ex. 5)

Item No.	Particulars of items	Quantity	Unit	Rate		Amount	
				Rs.	P.	Per	Rs. P.
1.	Earthwork in excavation in foundation	31.35	cu m	350.00		109.72	
2.	Earthwork in filling in plinth	25.61	cu m	275.00		70.43	
3.	Lime concrete in foundation	10.74	cu m	220.00		2362.80	
4.	1-class brickwork in foundation and plinth in 1 : 6 cement sand mortar	22.32	cu m	320.00		7142.40	
5.	2 cm damp proof course (D.P.C.) 1 : 2 cement mortar with water proofing compound	10.52	sq m	18.00		189.36	
6.	1-class brickwork in superstructure in lime mortar	30.10	cu m	320.00		9632.00	
7.	R.B. Work in lintels with 1 : 3 cement mortar excluding steel and its bending, but including centering and shuttering and binding steel.	1.788	cu m	520.00		929.76	
8.	R.C.C. work 1 : 1½ : 3 in verandah columns excluding steel and its bending, but including form work and binding steel complete fair finished	0.19	cu m	590.00		112.10	
9.	R.C.C. work 1 : 2 : 4 in slab excluding steel and its bending, but including centering and shuttering and binding steel, complete fair finished	8.328	cu m	775.00		6454.20	
10.	Mild steel including bending in reinforcement bars	8.10	q	515.00		4171.50	
11.	10 cm Lime concrete in roof terracing complete with surface finishing	53.60	sq m	12.00		643.20	
12.	3 cm thick insulation layer of sand and clay	53.60	sq m	1.50		80.40	
13.	Sal wood work in chaukhat wrought framed and fixed.	0.735	cu m	4700.00		3454.50	
							C.O. 35352.37

Item No.	Particulars of items	Quantity	Unit	Rate		Amount	
				Rs.	P.	Per	Rs. P.
14.	4 cm thick C.P. teak wood panelled door and window shutters including fittings	16.274	sq m	225.00		3661.65	
15.	4 cm thick C.P. teak wood glazed shutters including fittings	3.863	sq m	200.00		772.60	
16.	Iron work in hold fasts and window gratings	3.035	quintal	700.00		2124.50	
17.	12 mm thick plastering in walls 1 : 1 : 6 cement : lime : sand mortar	285.60	sq m	2.90		828.24	
18.	20 mm thick cement plaster in steps finished cement rendered	4.59	sq m	16.00		73.44	
19.	20 mm thick c.c. 1 : 2 : 4 floor over and including 8 cm lime concrete	50.00	sq m	18.65		932.50	
20.	2.5 cm thick c.c. 1 : 2 : 4 floor in sills	4.02	sq m	18.00		72.36	
21.	White washing 3 coats inside	203.64	sq m	0.75		152.73	
22.	Colour washing 2 coats over one coat of white washing outside	171.58	sq m	0.82		140.70	
23.	Painting doors and windows two coats over one coat of priming	65.77	sq m	10.40		684.00	
24.	Solignum painting two coats	9.19	sq m	3.50		32.16	
25.	C.I. pipe 10 cm dia. rain water spouts complete with painting	4.00	m	27.00		108.00	
							Total ... 44935.25
							Add 3% for Contingencies ... 1348.05
							Add 2% for Workcharged Establishment ... 898.70
							Grand Total ... 47181.00

## Plinth Area Rate (P.A.) —

$$\text{Plinth Area} = 8.40 \text{ m} \times 7.20 \text{ m} = 61.32 \text{ sq m (Say).}$$

$$\text{Plinth Area Rate} = \frac{\text{Total Cost}}{\text{Plinth Area}} = \text{Rs. } \frac{47181.00}{61.32} = \text{Rs. } 769.42 \text{ per sq m.}$$

**Note.** — The quantities of Earthwork in excavation in foundation (item 1), L.C. in foundation (item 3), Brickwork in foundation and plinth (item 4), Damp proof course (item 5), and Brickwork in superstructure (item 6) can be easily found by centre line method (See pages 110 and 111).

**Centre line method.** — (Ex. 5 Two-roomed building with front verandah.)

The quantities of Earthwork in excavation in foundation (item 1), Lime concrete in foundation (item 3), First class brickwork in foundation and plinth (item 4), Damp proof course (item 5), and First class brickwork in superstructure (item 6) may be calculated quickly by centre line method as follows :—

Total length of centre lines of all walls of room =  $(2 \times 8.10) + (3 \times 4.30) = 29.10$  m.

Number of junctions is two of similar walls.

Total length of all centre lines of all walls of verandah =  $8.20 + 2(2.75) = 13.70$  m.

Number of junction is two of dissimilar walls at the same level.

For centre line length and junctions see pages 94 and 95.

	No.	L. m	B. m	Ht. or D. m	Qntty.	Explanatory notes
1. Earthwork in excavation in foundation—						
Rooms	...	28.20	.90	.90	22.84	$L=29.10 - 2 \times \frac{.90}{2} = 28.20$ m
Verandah	...	12.80	.70	.90	8.06	$L=13.70 - 2 \times \frac{.90}{2} = 12.80$ m
				Total	30.90	
					cu m	
2. Lime concrete in foundation—						
Rooms	... 1	28.20	.90	.30	7.61	} Lengths same as above.
Verandah	... 1	12.80	.70	.30	2.69	
				Total	10.30	
					cu m	
3. I-class Brickwork in foundation and plinth in 1:6 cement mortar—						
Rooms—						
1st footing	... 1	28.40	.70	.20	3.98	$L=29.10 - 2 \times \frac{.70}{2} = 28.40$ m
2nd footing	... 1	28.50	.60	.10	1.71	$L = 29.10 - .60 = 28.50$ m
3rd footing	... 1	28.60	.50	.10	1.43	$L = 29.10 - .50 = 28.60$ m
Plinth wall above footing	... 1	28.70	.40	.80	9.18	$L = 29.10 - .40 = 28.70$ m

(Contd.)

## TWO-ROOMED BUILDING WITH FRONT VERADAH

	No.	L m	B m	Ht. of D. m	Qntty.	Explanatory notes
Verandah—						
1st footing	... 1	13.00	.50	.20	1.30	$L=13.70 - 2 \times \frac{.70}{2} = 13.00$ m
2nd footing	... 1	13.10	.40	.10	0.52	$L = 13.70 - .60 = 13.10$ m
Plinth wall above footing	... 1	13.20	.30	.10	0.40	$L = 13.70 - 50 = 13.20$ m
Plinth wall above footing	... 1	13.30	.30	.80	3.19	$L = 13.70 - .40 = 13.30$ m
				Total	21.71	
					cu m	

**Note.**— For steps in items 1, 3 and 4, adopt usual method as in pages 96 and 98.

5. 2 cm Damp proof course—						
Rooms	... 1	28.70	.40	—	11.48	Length same as plinth wall.
Deduct door sills	... 2	1.20	.40	—	0.96	
				Total	10.52	sq m
6. I-class brickwork in superstructure in lime mortar—						
Rooms	... 1	28.80	.30	4.00	34.56	$L = 29.10 - .30 = 28.80$ m
Verandah above lintel	... 1	13.40	.20	.30	0.80	$L = 13.70 - .30 = 13.40$ m
Parapet over room	... 1	25.20	.20	.60	3.02	Total centre line length $= 2 \times 8.20 + 2 \times 4.40 = 25.20$ m
Parapet over verandah	... 1	13.40	.20	.40	1.07	Total length= $1 \times 8.40 + 2 \times 2.50 = 13.40$ m
				Total	39.45	
Deduct openings lintels, etc.	... as usual	—	—	—	9.36	Details same as in page 99
				Net	Total	30.09
						cu m

**Note.** — The quantities estimated by the centre line method may be compared with those estimated by the general method in the previous pages.

THREE ROOMED BUILDING WITH FRONT AND BACK VERANDAH

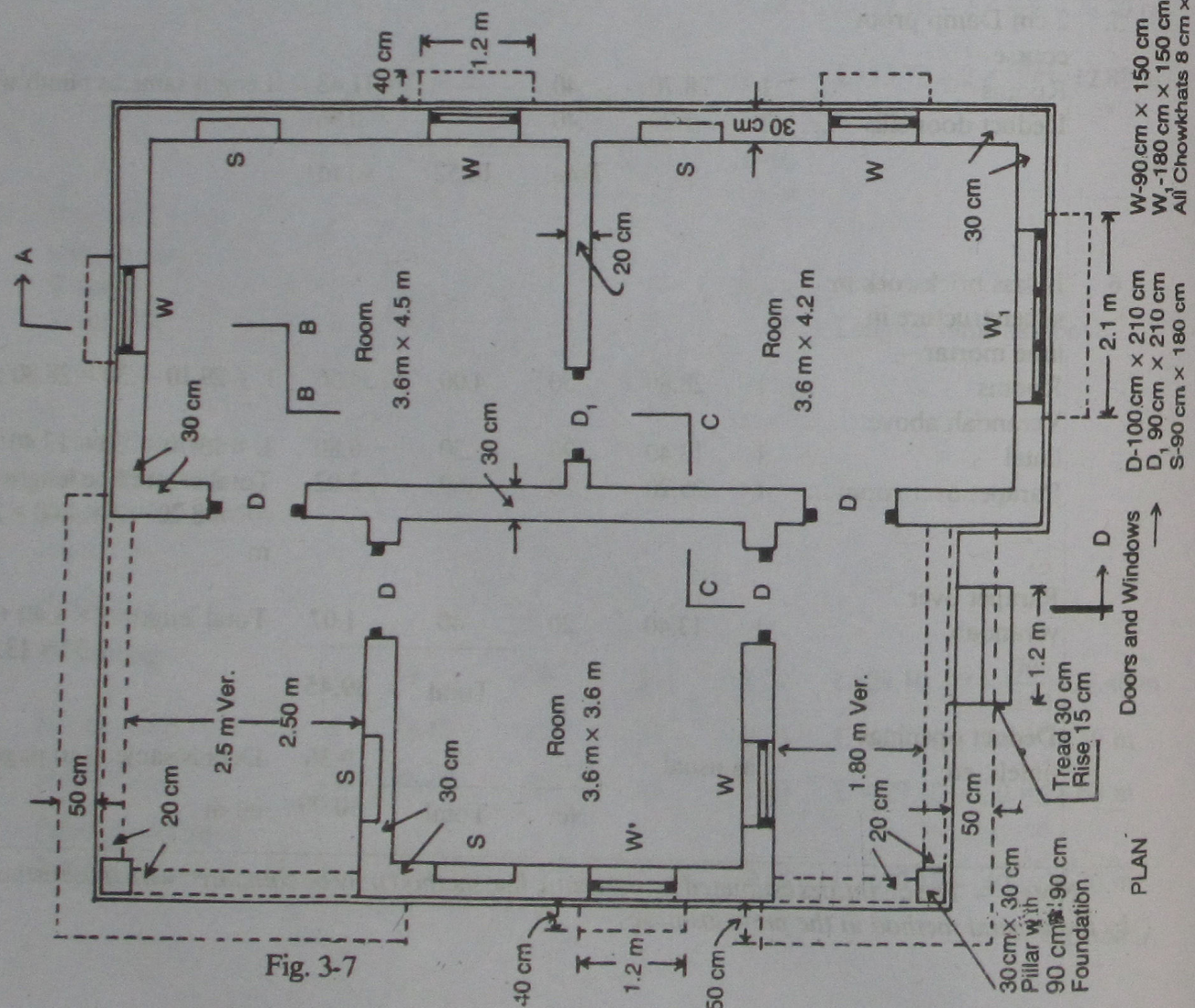
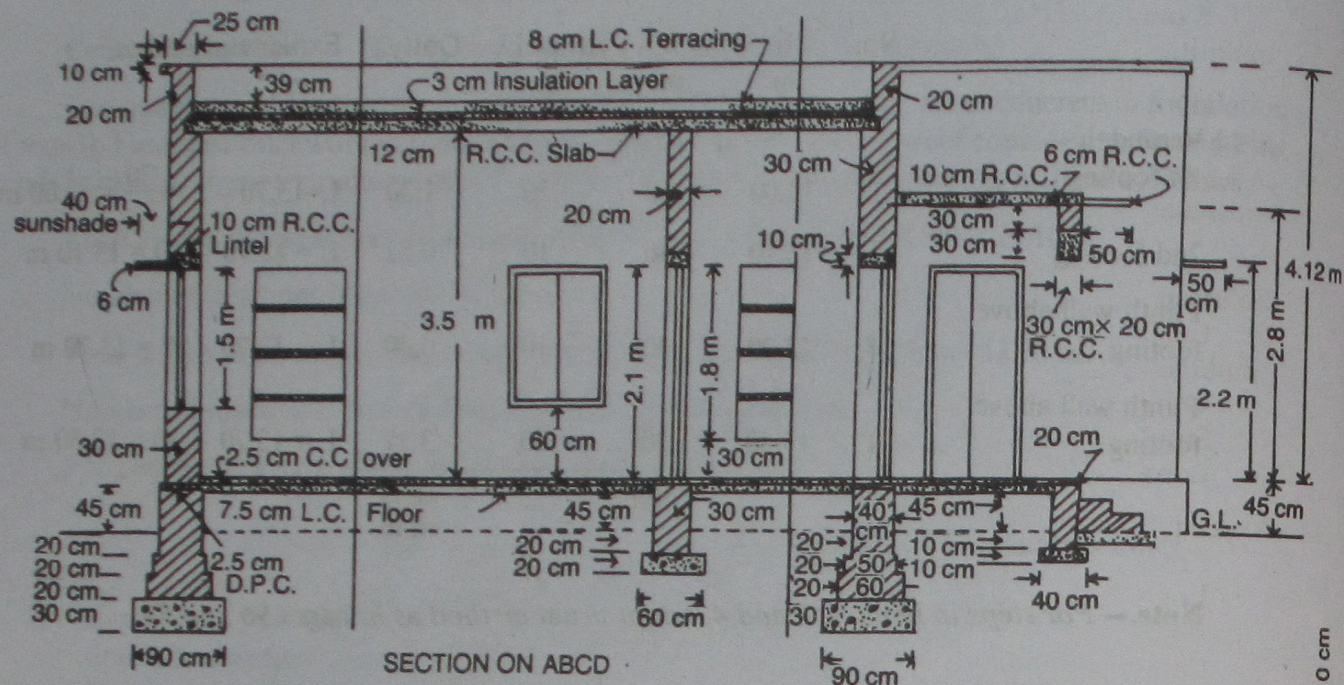

Fig. 3-7

ESTIMATE OF A THREE ROOMED BUILDING WITH FRONT AND BACK VERANDAHS

**Example 6.** — The plan and sectional elevation of a building are given in Fig. 3-7. Estimate the quantities of the following items of work of the building :—

- (1) Earthwork in excavation in foundation,
- (2) Lime concrete in foundation,
- (3) 1st class brickwork in lime mortar in foundation and plinth,
- (4) Damp proof course,
- (5) 1st class brickwork in 1 : 6 cement mortar in superstructure including parapet, sunshades, etc.,
- (6) R.C.C. work in roof slabs, lintels,
- (7) Steel reinforcement bars in R.C.C. work at 1%.

**Solution —**

Centre to centre lengths of two adjoining rooms (3.6 × 4.5 m room and 3.6 × 4.2 m room) combined —

Long walls — 9.20 m, Short walls — 3.90 m.

Square room — (3.6 × 3.6 m room)

Long walls — 3.90 m, Short walls — 3.90 m.

**Verandah.** — Centre to centre of 30 cm wall and 30 cm sq pillar —

Front Verandah (1.80 m ver.) —

Long wall (Front) — 3.90 m, Short wall (Side) — 2.00 m.

Back Verandah (2.50 m ver.) —

Long wall (Back) — 3.90 m, Short wall (Side) — 2.70 m.

**DETAILS OF MEASUREMENT AND CALCULATION OF QUANTITIES (Ex.)**

Item No.	Particulars of items and details of works	No.	Length m	Breadth m	Height or Depth m	Quantity	Explanatory notes
1.	<b>Earthwork in excavation in foundation —</b>						
	Adjoining room combined —						
	Long walls ...	2	10.10	0.90	0.90	16.36	L = 9.20 + .90 = 10.10 m
	Short walls ...	2	3.00	0.90	0.90	4.86	L = 3.90 - .90 = 3.00 m
	Inter 20 cm wall ...	1	3.00	0.60	0.40	0.72	L = 3.90 - .90 = 3.00 m
	Square room —						
	Long walls (outer) ...	1	4.80	0.90	0.90	3.88	L = 3.90 + .90 = 4.80 m
	Short walls ...	2	3.00	0.90	0.90	4.86	L = 3.90 - .90 = 3.00 m
	Verandah pillars ...	2	0.90	0.90	0.90	1.46	
	Verandah dwarf wall—Long walls (front and back) ...	2	3.00	0.40	0.20	0.48	L = 3.90 - .90 = 3.00 m
	Short wall front (side) ...	1	1.10	0.40	0.20	0.09	L = 2.00 - .90 = 1.10 m
	Short wall back (side) ...	1	1.80	0.40	0.20	0.15	L = 2.70 - .90 = 1.80 m
	Step ...	1	1.20	0.70	0.10	0.08	
		<b>Total</b>				<b>32.94</b>	<b>cu m</b>



Item No.	Particulars of items and details of works	No.	Length m	Breadth m	Height or Depth m	Quantity	Explanatory notes
2.	<b>Lime concrete in foundation—</b> Adjoining room combined —						
	Long walls ...	2	10.10	0.90	0.30	5.45	L same as in item (1).
	Short walls ...	2	3.00	0.90	0.30	1.62	L same as in item (1).
	Inter 20 cm wall ...	1	3.40	0.60	0.20	0.41	$L = 3.90 - .50 = 3.40$ m
	Square room —						
	Long wall (outer) ...	1	4.80	0.90	0.30	1.30	$L = 3.90 + .90 = 4.80$ m
	Short walls ...	2	3.00	0.90	0.30	1.62	$L = 3.90 - .90 = 3.00$ m
	Verandah pillars ...	2	0.90	0.90	0.30	0.49	
	Verandah dwarf wall—						
	Long walls (front and back) ...	2	3.50	0.40	0.10	0.28	$L = 3.90 - .40 = 3.50$ m
	Short walls front (side) ...	1	1.60	0.40	0.10	0.064	$L = 2.00 - .40 = 1.60$ m
	Short walls back (side) ...	1	2.30	0.40	0.10	0.092	$L = 2.70 - .40 = 2.30$ m
	Step ...	1	1.20	0.70	0.10	0.084	
					Total	11.41	
						cu m	
3.	<b>I-class brick work in lime mortar in foundation and plinth —</b> Adjoining rooms combined —						
	Long walls —						
	1st footing ...	2	9.80	0.60	0.20	2.35	$L = 9.20 + .60 = 9.80$ m
	2nd footing ...	2	9.70	0.50	0.20	1.94	$L = 9.80 - .10 = 9.70$ m
	Plinth wall ...	2	9.60	0.40	0.65	4.99	$L = 9.70 - .10 = 9.60$ m
	Short walls —						
	1st footing ...	2	3.30	0.60	0.20	0.79	$L = 3.90 - .60 = 3.30$ m
	2nd footing ...	2	3.40	0.50	0.20	0.68	$L = 3.30 + .10 = 3.40$ m
	Plinth wall ...	2	3.50	0.40	0.65	1.82	$L = 3.40 + .10 = 3.50$ m
	Inter 20 cm wall—						
	Plinth wall ...	1	3.50	0.30	0.65	0.68	$L = 3.90 - .40 = 3.50$ m
					C.O.	13.25	

(Ex. 6 Contd.)

Item No.	Particulars of items and details of works	No.	Length m	Breadth m	Height or Depth m	Quantity	Explanatory notes
	Square room in between verandah—				B.F.	13.25	
	Long wall (outer)—						
	1st footing ...	1	4.50	0.60	0.20	0.54	$L = 3.90 + .60 = 4.50$ m
	2nd footing ...	1	4.40	0.50	0.20	0.44	$L = 4.50 - .10 = 4.40$ m
	Plinth wall ...	1	4.30	0.40	0.65	1.12	$L = 4.40 - .10 = 4.30$ m
	Short walls —						
	1st footing ...	2	3.30	0.60	0.20	0.79	$L = 3.90 - .60 = 3.30$ m
	2nd footing ...	2	3.40	0.50	0.20	0.68	$L = 3.30 + .10 = 3.40$ m
	Plinth wall ...	2	3.50	0.40	0.65	1.82	$L = 3.40 + .10 = 3.50$ m
	Verandah Pillars						
	1st footing ...	2	0.60	0.60	0.20	0.15	
	2nd footing ...	2	0.50	0.50	0.20	0.10	
	Plinth wall ...	2	0.40	0.40	0.65	0.21	
	Verandah dwarf walls —						
	Long walls front and back ...	2	3.50	0.20	0.55	0.77	$L = 3.90 - .40 = 3.50$ m
	Short side wall (front) ...	1	1.60	0.20	0.55	0.18	$L = 2.00 - .40 = 1.60$ m
	Short side wall (back) ...	1	2.30	0.20	0.55	0.25	$L = 2.70 - .40 = 2.30$ m
	Step —						
	1st step ...	1	1.20	0.60	0.15	0.11	
	2nd step ...	1	1.20	0.30	0.15	0.05	
					Total	20.46	
						cu m	
4.	<b>2.5 cm damp proof course—</b> Adjoining room combined—						
	Long walls ...	2	9.60	0.40	—	7.68	L same as plinth wall.
	Short walls ...	2	3.50	0.40	—	2.80	
	Inter 20 cm wall ...	1	3.50	0.30	—	1.05	
	Square room —						
	Long wall (outer) ...	1	4.30	0.40	—	1.72	
	Short walls ...	2	3.50	0.40	—	2.80	
	Verandah Pillars ...	2	0.40	0.40	—	0.32	
					Total	16.37	
	Deduct Door Sills — D ...	4	1.00	0.40	—	1.60	
	D <sub>1</sub> ...	1	0.90	0.30	—	0.27	
					Total of deductions	1.87	
					Net	Total	14.50
							sq m

Item No.	Particulars of items and details of works	No.	Length m	Breadth m	Height or Depth m	Quantity	Explanatory notes
5.	<b>1st class brick-work in 1 : 6 cement mortar in super-structure —</b>						
	Adjoining rooms combined —						
	Long walls ...	2	9.50	0.30	3.62	20.63	Ht. up to top of slab.
	Short walls ...	2	3.60	0.30	3.62	7.82	Ht. up to top of slab.
	Inter 20 cm wall ...	1	3.60	0.20	3.50	2.52	Ht. up to bottom of slab.
	Square room in between verandah —						
	Long wall (outer)	1	4.20	0.30	3.62	4.56	$L = 3.90 + .30 = 4.20$ m
	Short walls ...	2	3.60	0.30	3.62	7.82	$L = 3.90 - .30 = 3.60$ m
	Verandah pillars	2	0.30	0.30	2.80	0.50	
	Verandah 20 cm wall above lintel—						
	Long wall (front and back)	2	3.60	0.20	0.30	0.43	
	Short wall front (side) ...	1	1.70	0.20	0.30	0.10	
	Short wall back (side) ...	1	2.40	0.20	0.30	0.14	
	<b>Parapet —</b>						
	Adjoining rooms —						
	Outer long wall (out to out)	1	9.50	0.20	0.50	0.95	Ht. of parapet = $.39 + .08 + .03 = 0.50$ m
	Short walls	2	4.00	0.20	0.50	0.80	$L = 9.20 + .30 = 9.50$ m $L = 3.60 + .30 + .10 = 4.00$ m
	Front verandah side	1	2.40	0.20	0.50	0.24	$L = 1.80 + .60 = 2.40$ m
	Back verandah side	1	2.50	0.20	0.50	0.25	$L = 2.50 + .20 - 0.20 = 2.50$ m
	Square room-outer wall ...	1	4.20	0.20	0.50	0.42	$L = 3.60 + .60 = 4.20$ m
	Walls in between ver. and room ...	2	3.90	0.20	0.50	0.78	$L = 3.60 + .20 + .10 = 3.90$ m
					Total	47.96	
						cu m	

Note.—Parapet is only on the outer main walls of rooms. Parapet may be taken in one operation by finding the total length of walls =  $34.40 \times 0.20 \times 0.50 = 3.44$  cu m.

(Ex. 6 Contd.)

Item No.	Particulars of items and details of works	No.	Length m	Breadth m	Height or Depth m	Quantity	Explanatory notes
	<b>Deduct —</b>						
	Door openings—						
	D ...	4	1.00	0.30	2.10	2.52	
	D <sub>1</sub>	1	0.90	0.20	2.10	0.38	
	Window openings						
	W ...	5	0.90	0.30	1.50	2.02	
	W <sub>1</sub>	1	1.80	0.30	1.50	0.81	
	Shelves	4	0.90	0.20	1.80	1.30	
	Lintels over doors, windows and shelves ...		Same marked	as for (a)	item 6	0.567	Bearing of roof slab not deducted may be deducted, if specified
			Total of	deduc-	tions	7.60	
				Net	Total	40.36	
						cu m	
6.	<b>R.C.C. work</b>						
	<b>1 : 2 : 4 excluding steel and its bending, but including centering and shuttering and binding steel</b>						
	Roof slab —						
	Adjoining rooms combined ...	1	9.20	3.90	0.12	4.306	Bearing 15 cm
	Square room ...	1	3.90	3.90	0.12	1.825	Bearing 15 cm
	Verandah front ...	1	4.05	2.15	0.10	0.871	Bearing 15 cm
	Verandah back ...	1	4.05	2.85	0.10	1.154	
	Verandah Chujja —						
	Front and back long ...	2	4.55	0.50	0.06	0.273	
	Side (front) ...	1	2.15	0.50	0.06	0.065	
	Side (back) ...	1	2.85	0.50	0.06	0.085	
	Sunshades over windows—						
	W ...	4	1.20	0.40	0.06	0.115	
	W <sub>1</sub> ...	1	2.10	0.40	0.06	0.050	
					C.O.	8.744	

Item No.	Particulars of items and details of works	No.	Length m	Breadth m	Height or Depth m	Quantity	Explanatory notes
					B.F.	8.744	
	Lintels over doors, windows, shelves—						
	Doors D ...	4	1.30	0.30	0.10	0.156 (a)	Bearing 15 cm
	Doors D <sub>1</sub> ...	1	1.20	0.20	0.10	0.024 (a)	Total of (a) s = 0.567 cu m
	Windows W ...	5	1.20	0.30	0.10	0.180 (a)	
	Windows W <sub>1</sub> ...	1	2.10	0.30	0.10	0.063 (a)	
	Shelves S ...	4	1.20	0.30	0.10	0.144 (a)	
	Verandah lintels						
	Front and back long ...	2	4.10	0.20	0.30	0.492	Bearing over wall 20 cm
	Side (front)	1	2.00	0.20	0.30	0.120	
	Side (back)	1	2.70	0.20	0.30	0.162	
					Total	10.085	
						cu m	
7.	Steel reinforcement bars including bending at 1% ...		10.085 × $\frac{1}{100}$		cu m = 0.1009	cu m	
					@ 78.5 q/cu m		
					= .1009 × 78.5 =	7.92 q	

Note. — Chujjas and sunshades may be taken under a separate item.

#### ABSTRACT OF QUANTITIES (Ex. 6)

1. Earthwork in excavation in foundation	...	32.94	cu m
2. Lime concrete in foundation	...	11.41	cu m
3. 1st class brickwork in lime mortar in foundation and plinth	...	20.46	cu m
4. 2.5 cm Damp proof course	...	14.50	sq m
5. 1st class brickwork in 1 : 6 cement mortar in superstructure	...	40.36	cu m
6. R.C.C. work 1 : 2 : 4 excluding steel and its bending but including centering and shuttering and binding steel	...	10.085	cu m
7. Steel reinforcement bars including bending	...	7.92	q

Item nos. 1 to 5 have been dealt by centre line method in the following pages.

Note — Students may estimate the remaining items of the building as exercise.

#### Centre Line Method (Ex. 6)

Estimate of the quantities of the items 1 to 5 by centre line method is as given below:—

- (i) Total centre line length of all 30 cm walls— Total centre line lengths of two long walls and two outer short walls of the right side rooms (combined) and of the three walls of the remaining room (square room) =  $(2 \times 9.20 + 2 \times 3.90) + (3 \times 3.90) = 37.90$  m. Numbers of junctions are two with 30 cm walls.
- (ii) Total centre line length of 20 cm inter wall = 3.90 m. Numbers of junctions are two with 30 cm walls.
- (iii) Total centre line length of all 20 cm walls of front and back verandah = Total centre line length of the front verandah long wall and side wall and of the back verandah long wall and side wall =  $(3.90 + 2.00) + (3.90 + 2.70) = 12.50$  m. Numbers of junctions are 8 (4 with 30 cm walls and 4 with 30 cm pillars).
- (iv) Total length of parapet wall, over outer walls of right side rooms and over outer walls of square room = Right side long wall + front and back outer walls + (walls by the right side of front and back verandahs) + (outer walls of square room + front and back walls of square room) =  $(9.50 + 2 \times 4.00 + 2.40 + 2.50) + (4.20 + 2 \times 3.90) = 22.40 + 12.00 = 34.40$  m.

Item No.	Particulars of items and details of works	No.	Length m	Breadth m	Height or Depth m	Quantity	Explanatory notes
1.	<b>Earthwork in excavation in foundation—</b>						
	All 30 cm walls ...	1	37.00	0.90	0.90	29.97	$L = 37.90 - 2 \times \frac{90}{2} = 37.00$ m
	20 cm inter wall ...	1	3.00	0.60	0.40	0.72	$L = 3.90 - 2 \times \frac{90}{2} = 3.00$ m
	Verandah pillars ...	2	0.90	0.90	0.90	1.46	
	All 20 cm wall of verandahs ...	1	8.90	0.40	0.20	0.71	$L = 12.50 - 8 \times \frac{90}{2} = 8.90$ m
	Step ...	1	1.20	0.60	0.10	0.07	
					Total	32.93	
						cu m	
2.	<b>Lime concrete in foundation</b>						
	All 30 cm walls ...	1	37.00	0.90	0.30	9.99	Length same as above.
	20 cm inter wall ...	1	3.40	0.60	0.20	0.41	$L = 3.90 - 2 \times \frac{50}{2} = 3.40$ m
	Verandah pillars ...	2	0.90	0.90	0.30	0.49	
	All 20 cm wall of verandah ...	1	10.90	0.40	0.10	0.44	$L = 12.50 - 8 \times \frac{40}{2} = 10.90$ m
	Step ...	1	1.20	0.60	0.10	0.07	
					Total	11.40	
						cu m	

Item No.	Particulars of items and details of works	No.	Length m	Breadth m	Height or Depth m	Quantity	Explanatory notes
3.	<b>First class brick-work in lime mortar in foundation and plinth</b>						
	All 30 cm walls—1st footing ...	1	37.30	0.60	0.20	4.48	$L=37.90 - 2 \times \frac{.60}{2} = 37.30$ m
	2nd footing ...	1	37.40	0.50	0.20	3.74	$L=37.90 - 2 \times \frac{.50}{2} = 37.40$ m
	Plinth wall ...	1	37.50	0.40	0.65	9.75	$L=37.90 - 2 \times \frac{.40}{2} = 37.50$ m
	20 cm inter wall, plinth ...	1	3.50	0.30	0.65	0.68	$L=8.90 - 2 \times \frac{.40}{2} = 3.50$ m
	Verandah pillars	2	0.60	0.60	0.20	0.15	Same as in page 132.
	1st footing ...	2	0.50	0.50	0.20	0.10	
	Plinth wall ...	2	0.40	0.40	0.65	0.21	
	All 20 cm verandah walls, plinth	1	10.90	0.20	0.55	1.20	$L=12.50 - 8 \times \frac{.40}{2} = 10.90$ m
	Steps—						Same as in page 130.
	1st ...	1	1.20	0.60	0.15	0.11	
	2nd ...	1	1.20	0.30	0.15	0.05	
						Total	20.47 cu m
4.	<b>2.5 cm Damp Proof course—</b>						Length same as plinth wall.
	All 30 cm walls ...	1	37.50	0.40	—	15.00	
	20 cm inter walls ...	1	3.50	0.30	—	1.05	
Verandah pillars ...	2	0.40	0.40	—	0.32		
						Total	16.37
	Deduct door sills	Same as in page 115				1.87	
			Net	Total		14.50 sq m	
5.	<b>First class brick-work in 1:6 cement mortar in superstructure</b>						
	All 30 cm walls ...	1	37.60	0.30	3.62	40.83	$L=37.90 - 2 \times \frac{.30}{2} = 37.60$ m
	20 cm inter wall ...	1	3.60	0.20	3.50	2.52	$L=3.90 - 2 \times \frac{.30}{2} = 3.60$ m
	Verandah pillars ...	2	0.30	0.30	2.80	0.50	No. of junctions 4 with 30 cm walls.
	All 20 cm walls of verandah above lintel including over pillars ...	1	11.90	0.20	0.30	0.71	$L=12.50 - 4 \times \frac{.30}{2} = 11.90$ m
	Parapet (all walls) 20 cm walls ...	1	34.40	0.20	0.40	2.75	Total length of all walls as in page 119.
	25 cm coping ...	1	34.40	0.25	0.10	0.86	
						Total	48.17
	Deduct doors and window opening and lintels ...	same as in page 117				7.60	
			Net	Total		40.57 cu m	

**Example 7.**— Estimate the quantities of the following items of work of the six-roomed building from the given drawings, Figs. 3-8 and 3-9:—

(1) Earthwork in excavation in foundation, (2) Earthwork in filling in plinth, (3) Lime concrete in foundation, (4) First class brickwork in 1:6 cement sand mortar in foundation and plinth, (5) 2.5 cm Damp proof course, (6) First class brickwork in lime mortar in superstructure, (7) R.C.C. work, in roof slab, beam, lintel, sun shade, etc. excluding steel, (8) Steel work in reinforcement in R.C.C. work, (9) Lime concrete terracing in roof, and (10) Bitumen insulation layer in roof.

SIX ROOMED BUILDING  
WITH FRONT AND BACK VERANDAHS AND SIDE ROOMS CROSS-SECTION,

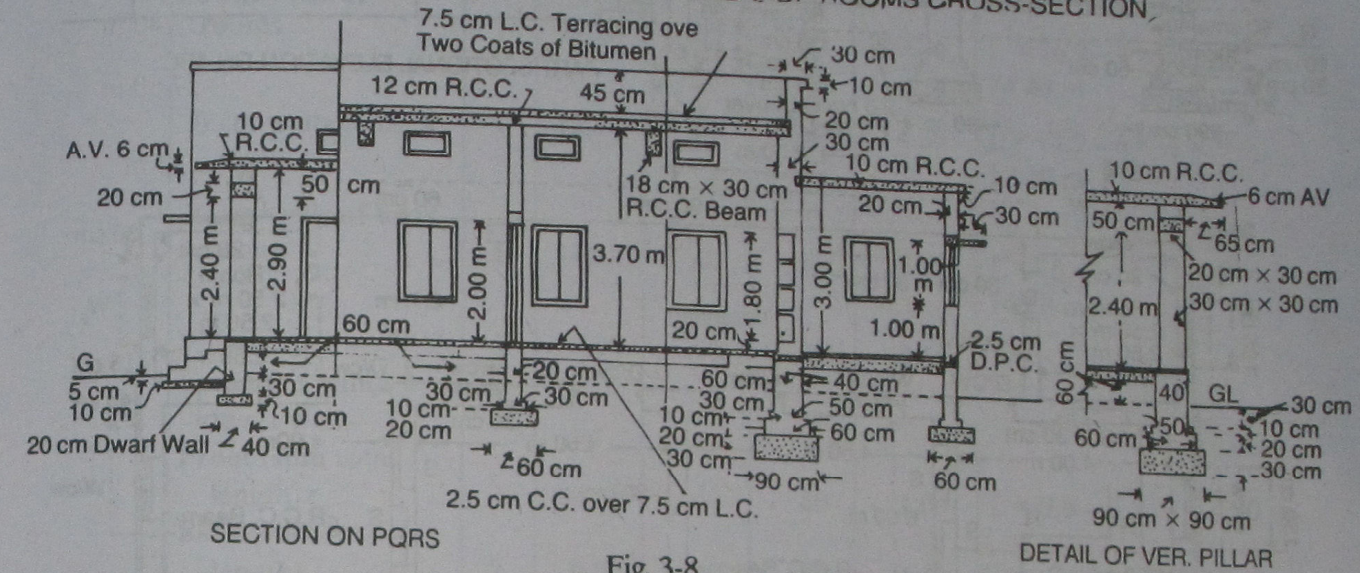

Fig. 3-8

SECTION ON PQRS  
Centre to centre length of walls —  
30 cm walls —

Total centre to centre length of left side rooms and right side rooms  
= 2 [2(4.5 + 5.0 + .2 + .3) + 2(4.0 + .30)] = 2 [20.0 + 8.6] = 57.20 m

Total centre to centre length of central rooms  
= 2(4.5 + 4.5 + .2 + .3) = 2 × 9.5 = 19.00 m

Total centre to centre length of all 30 cm walls  
= 57.20 + 19.00 = 76.20 m

Number of junctions = 4 (junctions with 30 cm walls).

20 cm walls —

Total centre to centre length of 20 cm partition walls in rooms  
= 2 × 4.30 + 6.30 = 14.90 m

Number of junctions — 6 (junctions with 30 cm walls).

Total centre length of 20 cm walls of back side rooms  
= 2(2 × 2.75 + 2.70) = 16.40 m

Number of junctions = 4 (junctions with 30 cm walls).

Centre to centre length of front verandah = 9.50 m

Centre to centre length of back verandah

= (4.0 + 4.5 + 4.5 + 4.0 + 4 × .30 + .20) — (2 × 2.90) + .20 = 12.80 m

Parapet — Parapet is only over the outer main walls of rooms.

Total centre length of parapets =

Left and right side lengths + back side length + front side lengths

2 × 10.1 + 18.2 + 2 × 4.4 + 9.40 + 2 × 3.70 = 64.00 m

**Note.**— In this example items 1, 3, 4, 5 and 6 have been estimated by centre line method in the following pages.

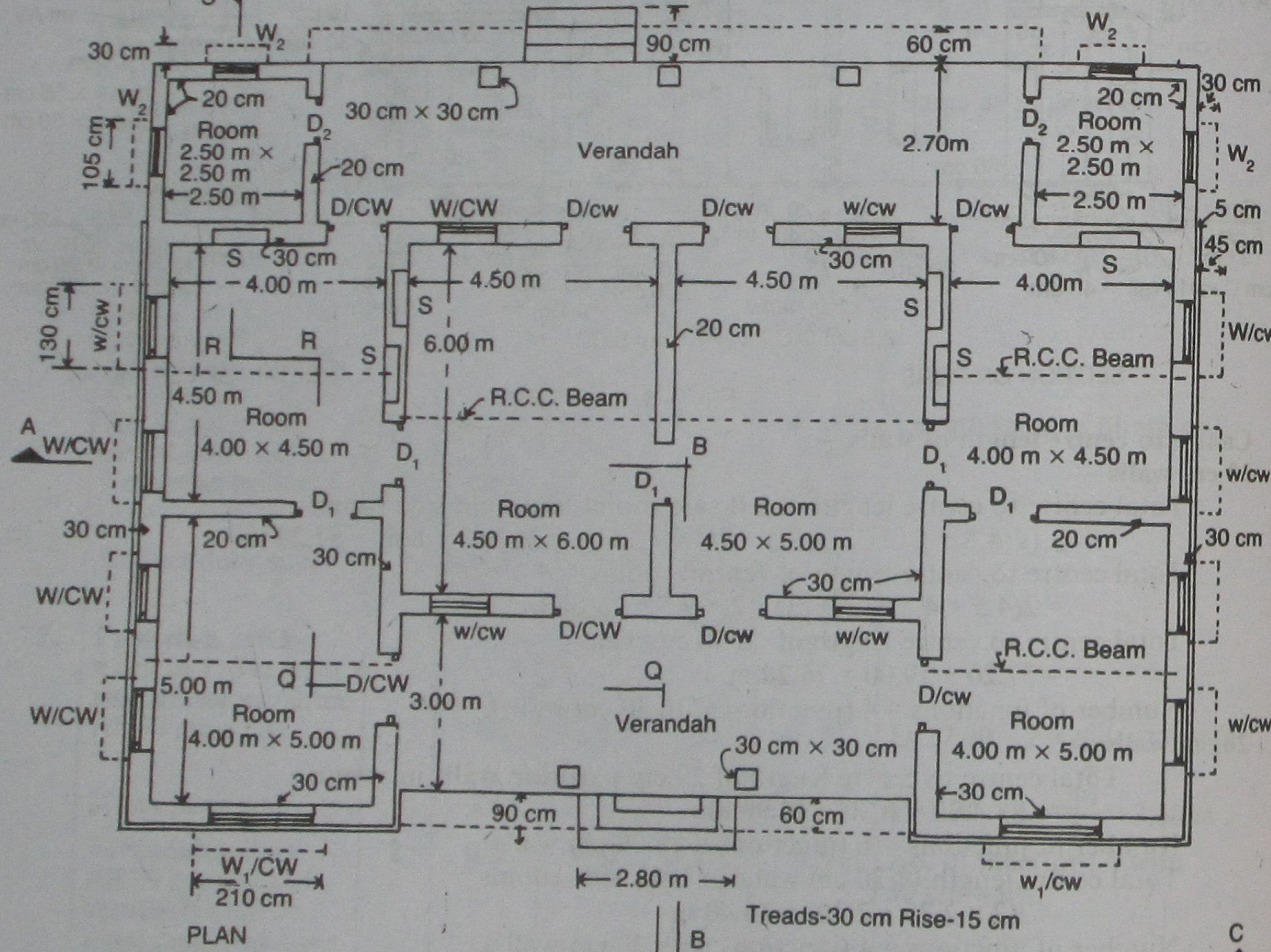
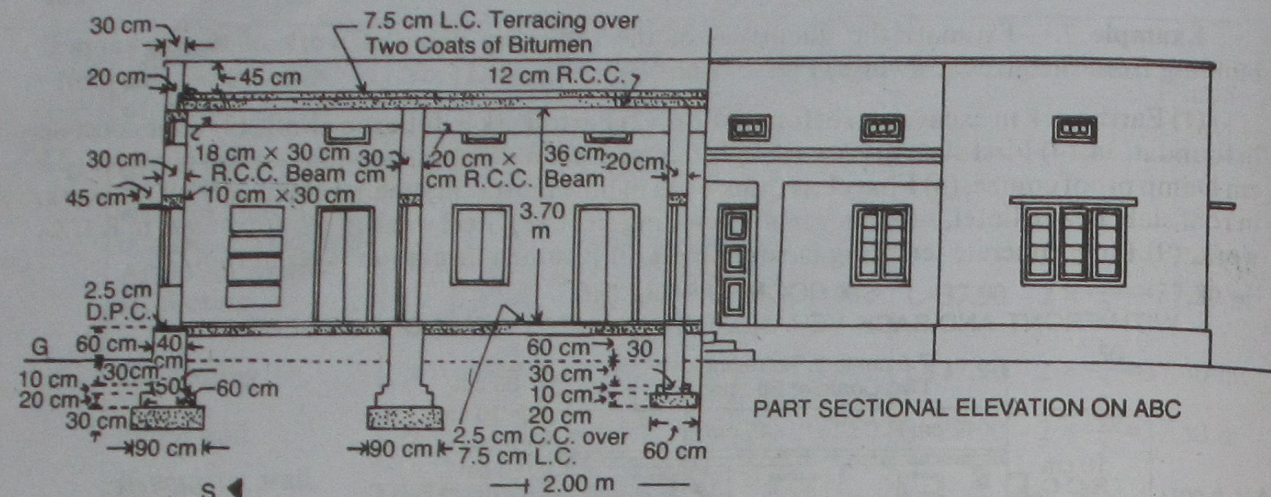

Sizes	Shutters	Chaukhats
D-120 cm x 200 cm	Part Panelled Part Glazed	12 cm x 8 cm
D <sub>1</sub> -110 cm x 200 cm	Fully Panelled	12 cm x 8 cm
D <sub>2</sub> -80 cm x 180 cm	Fully Panelled	10 cm x 7.5 cm
W-100 cm x 150 cm	Fully Glazed	10 cm x 7.5 cm
W <sub>1</sub> -180 cm x 150 cm		
W <sub>2</sub> -75 cm x 100 cm		
CW-75 cm x 50 cm	Fully Glazed	7.5 cm x 7.5 cm
S-100 cm x 180 cm	4 cm Precast R.C.C. Slab.	

Fig. 3-9

Item No.	Particulars of items and details of works	No.	Length m	Breadth m	Height or Depth m	Quantity	Explanatory notes
1.	<b>Earthwork in excavation in foundation—</b>						
	30 cm walls of rooms	1	74.40	.90	.90	60.26	$L = 76.2 - 4 \times \frac{1}{2} \times .9 = 74.40 \text{ m}$
	20 cm walls of back room	1	12.20	.60	.60	4.39	$L = 14.9 - 6 \times \frac{1}{2} \times .9 = 12.20 \text{ m}$
	20 cm walls of back rooms	1	14.60	.60	.60	5.26	$L = 16.4 - 4 \times \frac{1}{2} \times .9 = 14.60 \text{ m}$
	Pillars	5	.90	.90	.90	3.65	
	Verandah plinth dwarf wall—						
	Front (sum total length)	1	6.80	.40	.40	1.09	$L = 9.5 - 3 \times .9 = 6.80 \text{ m}$
	Back (sum total length)	1	9.50	.40	.40	1.52	$L = 12.80 - 3 \times .9 = 9.50 \text{ m}$
	Step front	1	2.90	.95	.15	0.41	} 5 cm projections.
	Step back	1	2.10	.95	.15	0.30	
	<b>Total</b>					76.88	cu m
2.	<b>Earthwork in filling in plinth—</b>						
	Left and right side rooms—						
	(i)	2	3.90	4.45	.525	18.22	
	(ii)	2	3.90	4.95	.525	20.27	
	Central rooms	2	4.45	5.90	.525	27.57	
	Back side rooms	2	2.50	2.45	.525	6.43	
	Front verandah	1	9.10	2.75	.525	13.14	
	Back verandah	1	12.60	2.45	.525	16.21	
	<b>Total</b>					101.84	
	Deduct pillars	5	.40	.20	.525	.21	This may be neglected.
	<b>Total</b>					101.63	cu m

Item No.	Particulars of items and details of works	No.	Length m	Breadth m	Height or Depth m	Quantity	Explanatory notes
3.	<b>Lime concrete in foundation—</b>						
	30 cm walls of rooms ...	1	74.40	.90	.30	20.09	L same as excavation.
	20 cm walls of rooms ...	1	13.10	.60	.20	1.57	$L = 14.9 - 6 \times \frac{1}{2} \times .6 = 13.10 \text{ m}$
	20 cm walls of back small rooms ...	1	15.20	.60	.20	1.82	$L = 16.4 - 4 \times \frac{1}{2} \times .6 = 15.20 \text{ m}$
	Pillars ...	5	.90	.90	.30	1.22	
	Plinth dwarf wall—						
	Front (sum total length) ...	1	8.00	.40	.10	0.32	$L = 9.5 - 3 \times .5 = 8.00 \text{ m}$
	Back (sum total length) ...	1	11.00	.40	.10	0.44	$L = 12.80 - 3 \times .5 - .3 = 11.00 \text{ m}$
	Step front ...	1	2.90	.95	.10	0.28	
	Step back ...	1	2.10	.95	.10	0.20	
				Total	25.94	cu m	
4.	<b>1st class brick-work in 1:6 cement mortar in foundation and plinth—</b>						
	30 cm walls of rooms—						
	1st footing ...	1	75.00	.60	.20	9.00	$L = 76.2 - 4 \times \frac{1}{2} \times .6 = 75.00 \text{ m}$
	2nd footing ...	1	75.20	.50	.10	3.76	$L = 76.2 - 4 \times \frac{1}{2} \times .5 = 75.20 \text{ m}$
	Plinth wall above footing ...	1	75.40	.40	.90	27.14	$L = 76.2 - 4 \times \frac{1}{2} \times .4 = 75.40 \text{ m}$
	20 cm walls of rooms—						
	Footing ...	1	13.40	.30	.10	0.40	$L = 14.9 - 6 \times \frac{1}{2} \times .5 = 13.40 \text{ m}$
	Plinth wall above footing ...	1	13.70	.20	.90	2.47	$L = 14.9 - 6 \times \frac{1}{2} \times .4 = 13.70 \text{ m}$
	20 cm walls of back small rooms—						
	Footing ...	1	15.40	.30	.10	0.46	$L = 16.4 - 4 \times \frac{1}{2} \times .5 = 15.40 \text{ m}$
				C.O.	43.23		

(Ex. 7 Contd.)

Item No.	Particulars of items and details of works	No.	Length m	Breadth m	Height or Depth m	Quantity	Explanatory notes
	Plinth wall above footing ...	1	15.60	.20	B.F. .90	43.23	
	Pillars—						
	1st footing ...	5	.60	.60	.20	2.81	$L = 16.4 - 4 \times \frac{1}{2} \times .4 = 15.60 \text{ m}$
	2nd footing ...	5	.50	.50	.10	0.36	
	Plinth wall above footing ...	5	.40	.40	.90	0.13	
	Verandah plinth dwarf wall						
	Front (sum total length) ...	1	8.30	.20	.90	0.72	
	Back (sum total length) ...	1	11.40	.20	.90	1.49	$L = 9.5 - 3 \times .4 = 8.30 \text{ m}$
	Step front—						
	1st step ...	1	2.80	.90	.15	2.05	$L = 12.8 - 3 \times .40 - .2 = 11.40 \text{ m}$
	2nd step ...	1	2.20	.60	.15	0.38	
	3rd step ...	1	1.60	.30	.15	0.20	
	Step back—						
	1st step ...	1	2.00	.90	.15	0.07	
	2nd step ...	1	2.00	.60	.15	0.27	
	3rd step ...	1	2.00	.30	.15	0.18	
					Total	51.98	
						cu m	
5.	<b>2.5 cm damp proof course—</b>						
	30 cm walls of rooms ...	1	75.40	.40	—	30.16	Length same as for plinth wall in item 4.
	20 cm walls of rooms ...	1	13.70	.20	—	2.74	
	20 cm walls of back rooms ...	1	15.60	.20	—	3.12	
	Pillars ...	5	.40	.40	—	0.80	
					Total	36.82	
	Deduct doors sills—						
	D in 30 cm wall ...	8	1.20	.40	—	3.84	
	D <sub>1</sub> in 30 cm wall ...	2	1.10	.40	—	0.88	
	D <sub>1</sub> in 20 cm wall ...	3	1.10	.20	—	0.66	
D <sub>2</sub> in 20 cm wall ...	2	.80	.20	—	0.32		
				Total	5.70		
				Net	31.12	sq m	

Item No.	Particulars of items and details of works	No.	Length m	Breadth m	Height or Depth m	Quantity	Explanatory notes
6.	<b>I-class brick-work in lime mortar in superstructure</b>						
	30 cm walls of rooms ...	1	75.60	.30	3.70	83.92	$L = 76.2 - 4 \times \frac{1}{2} \times .30 = 75.60$ m
	30 cm walls of rooms ...	1	14.00	.20	3.70	10.36	$L = 14.9 - 6 \times \frac{1}{2} \times .30 = 14.00$ m
	20 cm walls of back rooms ...	1	15.80	.20	2.90	9.16	$L = 16.4 - 4 \times \frac{1}{2} \times .30 = 15.80$ m
	Pillars ...	5	0.30	.30	2.40	1.08	
	Verandah 30 cm wall above pillars above lintel—						
	Front ...	1	9.20	.30	.30	0.83	$L = 9.5 - .3 = 9.20$ m
	Back ...	1	12.50	.30	.30	1.13	$L = 12.8 - .3 = 12.50$ m
	Parapet 20 cm wall	1	64.00	.20	.545	6.98	$Ht. = .35 + .075 + .12 = .545$ m
	Upper 30 cm coping	1	64.00	.30	.10	1.92	
					Total	115.38	
	<b>Deduct —</b>						
	Door openings—						
	D in 30 cm wall ...	8	1.20	.30	2.00	5.76	
	D <sub>1</sub> in 30 cm wall ...	2	1.10	.30	2.00	1.32	
	D <sub>1</sub> in 20 cm wall ...	3	1.10	.20	2.00	1.32	
	D <sub>2</sub> in 20 cm wall ...	2	0.80	.20	1.80	0.58	
	Window openings—						
	W in 30 cm wall ...	12	1.00	.30	1.50	5.40	
	W <sub>1</sub> in 30 cm wall ...	2	1.80	.30	1.50	1.62	
	W <sub>2</sub> in 20 cm wall ...	4	0.75	.20	1.00	0.60	
	C.W. openings in 30 cm wall ...	22	0.75	.30	.50	2.48	
	Shelve openings ...	6	1.00	.20	1.80	2.16	Back wall 10 cm thick.

(Ex. 7 Contd.)

Item No.	Particulars of items and details of works	No.	Length m	Breadth m	Height or Depth m	Quantity	Explanatory notes
	R.C.C. lintels—						
	Over doors—D ...	8	1.40	.30	.10	.336	(a) 10 cm bearing.
	D <sub>1</sub> ...	2	1.30	.30	.10	.078	(a)
	D <sub>1</sub> ...	3	1.30	.20	.10	.078	(a)
	D <sub>2</sub> ...	2	1.00	.20	.10	.040	(a)
	Over windows W ...	12	1.20	.30	.10	.432	(a)
	W <sub>1</sub> ...	2	2.00	.30	.10	.120	(a)
	W <sub>2</sub> ...	4	.95	.20	.10	.076	(a)
	Over C.S. windows	22	.95	.30	.10	.627	(a)
	Over shelves ...	6	1.20	.30	.10	.216	(a) Total of (a) s = 2.003.
	Bearing of verandah Lintels ...	2×2	.15	.30	.20	.036	15 cm bearing.
					Total	23.279	
					Net	Total	92.101 cu m
7.	<b>R.C.C. work excluding steel and its bending but including centering and shuttering and binding steel—</b>						
	R.C.C. beams ...	4	4.40	.18	.30	0.950	20 cm bearing.
		2	4.80	.20	.36	0.691	
	R.C.C. roof slab—						
	Left side and right side rooms ...	2	10.00	4.30	.12	10.320	15 cm bearing.
	Central rooms ...	1	9.50	6.30	.12	7.182	
	Back side rooms ...	2	2.95	2.95	.10	1.741	Including 10 cm projections.
	Verandah—						
	Front ...	1	9.50	2.95	.10	2.803	Excluding chujja.
	Back ...	1	12.80	2.65	.10	3.392	
	Chujja front ...	1	9.50	.65	.06	0.371	6 cm average thickness.
	Chujja back ...	1	13.00	.65	.06	0.507	
	Sun shades						
	Over windows—						
	W ...	8	1.30	.45	.05	0.234	15 cm extended both ends.
	W <sub>1</sub> ...	2	2.10	.45	.05	0.095	
	W <sub>2</sub> ...	4	1.05	.30	.05	0.063	
					C.O.	28.349	

Item No.	Particulars of items and details of works	No.	Length m	Breadth m	Height or Depth m	Quantity	Explanatory notes
	Lintels— Over front verandah pillars	1	9.50	.30	.20	0.570	15 cm bearing.
	Over back verandah pillars	1	13.00	.30	.20	0.780	15 cm bearing.
	Over doors and windows	Same as marked (a) in		item 6		2.003	
					Total	31.702 cu m	
8.	Mild steel work incl- uding bending in re- inforcement in R.C.C. work @ 1%	31.702	$\times 1 =$	0.31702			Density of mild steel 78.5 q/cu m
		100		$= 0.31702 \times 78.5$		24.89 q	
9.	7.5 cm Lime concrete roof, terracing— Left and right side rooms	2	9.90	4.20		83.16	10 cm bearing.
	Central rooms	1	9.60	6.20		59.52	
					Total	142.68 sq m	
10.	Bitumen insulation layer of two coats in roof	Same as in item 9 above				142.68 sq m	

ABSTRACT OF QUANTITIES

1. Earthwork in excavation in foundation	76.88	cu m
2. Earthwork in filling in plinth	101.63	cu m
3. Lime concrete in foundation	25.94	cu m
4. 1st class brickwork in 1:6 cement mortar in foundation and plinth	51.98	cu m
5. 2.5 cm Damp proof course	31.12	sq m
6. 1st class brickwork in lime mortar in superstructure	92.101	cu m
7. R.C.C. work excluding steel and its bending but including centering and shuttering and binding steel	31.702	cu m
8. Mild steel work in reinforcement including bending in R.C.C. work	24.89	q
9. 7.5 cm lime concrete roof terracing	142.68	sq m
10. Bitumen insulation layer of two coats in roof	142.68	sq m

CIRCULAR SEMICIRCULAR, HEXAGONAL, HALF HEXAGONAL  
ETC. ROOMS

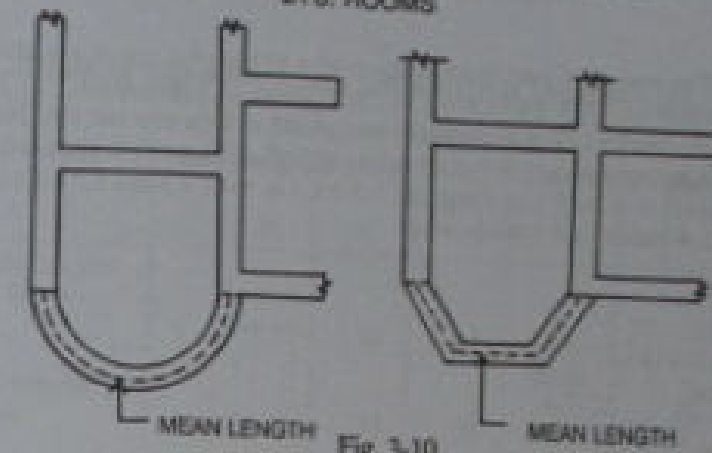

For rooms circular, semi-circular, hexagonal, half-hexagonal, etc., the total centre line length of all walls may be found out and the quantities may be calculated multiplying the respective breadth and height. For semi-circular, half-hexagonal, etc., the centre line length (mean length) of these portions may also be found out and dealt separately.

ESTIMATE OF A HEXAGONAL ROOM

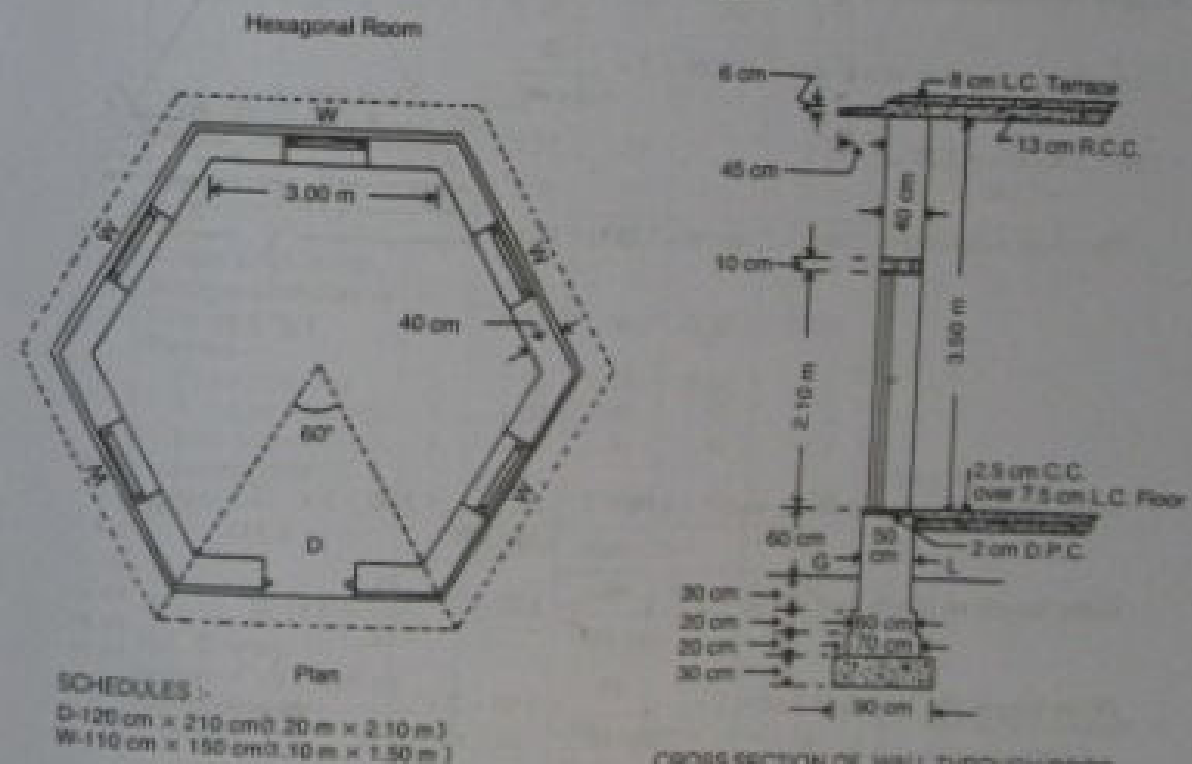

Fig. 3-11



**Example 8.** — The plan and part cross-section of a hexagonal room are given in (Fig. 3-11). Estimate the quantities of— (1) Earthwork in excavation in foundation, (2) Lime concrete in foundation, (3) I-class brickwork in foundation and plinth in lime mortar, (4) Damp proof course, (5) I-class brickwork in superstructure in lime mortar, (6) R.C.C. work in roof including chujja and lintels, (7) Lime concrete in roof terracing, (8) 2.5 cm c.c. over 7.5 cm L.C. floor and (9) 12 mm cement plastering 1:6 inside and outside walls.

The length of the centre line and the area of the hexagon may be calculated as below:—

Fig. 3-12 represents  $\frac{1}{4}$  of the hexagon. The sides of a hexagon form equilateral triangles at the centre.

$$\text{Length of centre line of one side } L_c = 3.00 + 2 \times \frac{.20}{\tan 60^\circ}$$

$$= 3.00 + 2 \times \frac{.20}{1.732} = 3.23 \text{ m.}$$

Therefore, total length of centre lines =  $6 \times 3.23 = 19.38 \text{ m.}$

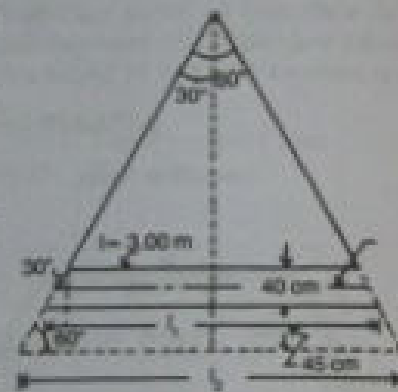

Fig. 3-12

$$\text{Outer length of superstructure wall } L_s = 3.00 + 2 \times \frac{.40}{\tan 60^\circ} = 3.00 + 2 \times \frac{.40}{1.732} = 3.46 \text{ m}$$

$$\text{Outer length of plinth wall} = 3.00 + 2 \times \frac{.45}{\tan 60^\circ} = 3.00 + 2 \times \frac{.45}{1.732} = 3.52 \text{ m}$$

$$\text{Outer length of Chujja } L_c = 3.00 + 2 \times \frac{.85}{\tan 60^\circ} = 3.00 + 2 \times \frac{.85}{1.732} = 3.98 \text{ m}$$

$$\text{Floor area} = 6 \times \text{area of one inside triangle} = 6 \times \left(\frac{1}{2} \times \text{base} \times \text{altitude}\right) = 6 \times \left(\frac{1}{2} \times 3.00 \times 3.00 \times \frac{1}{2} \times \tan 60^\circ\right) = 6 \times \left(\frac{1}{2} \times 3 \times 3 \times \frac{1}{2} \times 1.732\right) = 23.38 \text{ sq m}$$

$$\text{Roof area} = 6 \times \text{area of one outside triangle} = 6 \times \left(\frac{1}{2} \times 3.46 \times 3.46 \times \frac{1}{2} \times 1.732\right) = 31.10 \text{ sq m}$$

Details of Measurement and Calculation of Quantities (Ex. 8)

Item No.	Particulars of items and details of works	No.	Length m	Breadth m	Height or Depth m	Quantity	Explanatory notes
1.	Earthwork in excavation in foundation	1	19.38	.90	1.00	17.44	} L = Total length of center lines. } 3/10 of excavation.
2.	Lime concrete in foundation	1	19.38	.90	.30	5.23	
3.	I-class brick-work in foundation and plinth in lime mortar— 1st footing ... 1 19.38 .70 .20 2.71 2nd footing ... 1 19.38 .60 .20 2.33 Plinth wall ... 1 19.38 .50 .90 8.72					13.76	
					Total	cu m	
4.	2 cm Damp proof course	1	19.38	.50	—	9.69	
	Deduct door sill	1	1.20	.50	—	0.60	
					Net	Total	
5.	I-class brick-work in super-structure in lime mortar	1	19.38	.40	3.50	27.13	
	Deduct— Door openings ... 1 1.20 .40 2.10 1.01 Window openings ... 5 1.10 .40 1.50 3.30 Lintels over door ... 1 1.40 .40 .10 0.06 Lintels over windows ... 5 1.30 .40 .10 0.26					4.63	} 40 cm bearing.
					Total of deduction	4.63	
					Net	Total	
6.	R.C.C. work complete with steel reinforcement— Roof slab	$6 \times \frac{1}{2} \times 3.46 \times \frac{3.46}{2} \times 1.732 \times .13$				4.043	} 6 × area of one triangle of side of outer wall × thickness. } 6 × mean length × breadth × thickness.
	Chujja	$6 \times \frac{3.46 + 3.98}{2} \times .45 \times .06$				0.603	
	Lintels	Same as above in item	(5)			0.320	
					Total	4.966	
						cu m	

Item No.	Particulars of items and details of works	No.	Length m	Breadth m	Height or Depth m	Quantity	Explanatory notes
7.	8 cm Lime concrete in roof terracing	6	$\times \frac{1}{2} \times 3.46$	$\times \frac{3.46}{2}$	$\times 1.732$	31.10 sq m	Same area as for R.C.C. roof.
8.	2.4 cm c.c. over and including 7.5 cm L.C. floor	6	$\times \frac{1}{2} \times 3$	$\times \frac{3}{2}$	$\times 1.732$	23.38 sq m	6 × area of one triangle of side of inner length.
9.	12 mm cement plastering 1:6 in walls—						
	Inside	6	3.00	—	3.50	63.00	
	Outside above plinth	6	3.46	—	3.50	72.66	
	Outside plinth wall	6	3.52	—	.70	14.78	Including 10 cm below G.L.
					Total	150.44	
	Deduct Door opening	1	1.20	—	2.10	2.52	} One face.
	Deduct Window	5	1.10	—	1.50	8.25	
					Total	10.77	
					Net	Total	139.67 sq m

## ABSTRACT OF QUANTITIES (Ex. 8)

1. Earthwork in excavation in foundation	...	17.44	cu m
2. Lime concrete in foundation	...	5.23	cu m
3. I-class brickwork in foundation and plinth in lime mortar	...	13.76	cu m
4. 2 cm Damp proof course	...	9.09	sq m
5. I-class brickwork in superstructure in lime mortar	...	22.50	cu m
6. R.C.C. work complete with steel reinforcement	...	4.966	cu m
7. 8 cm Lime concrete in roof terracing	...	31.10	sq m
8. 2.5 cm c.c. over and including 7.5 cm L.C. floor	...	23.38	sq m
9. 12 mm Cement plastering 1 : 6 in walls	...	139.67	sq m

**Example 9.** — From the attached plan and the detail of wall section (Fig. 3-13) estimate the quantities of—

- (1) Earthwork in foundations.
- (2) Concrete in foundations.
- (3) Brickwork in foundation and plinth in 1:6 cement mortar.
- (4) 2 cm Damp proof course at plinth level.
- (5) Brickwork in superstructure in lime mortar.
- (6) 2.5 cm c.c. over 7.5 cm L.C. floor.

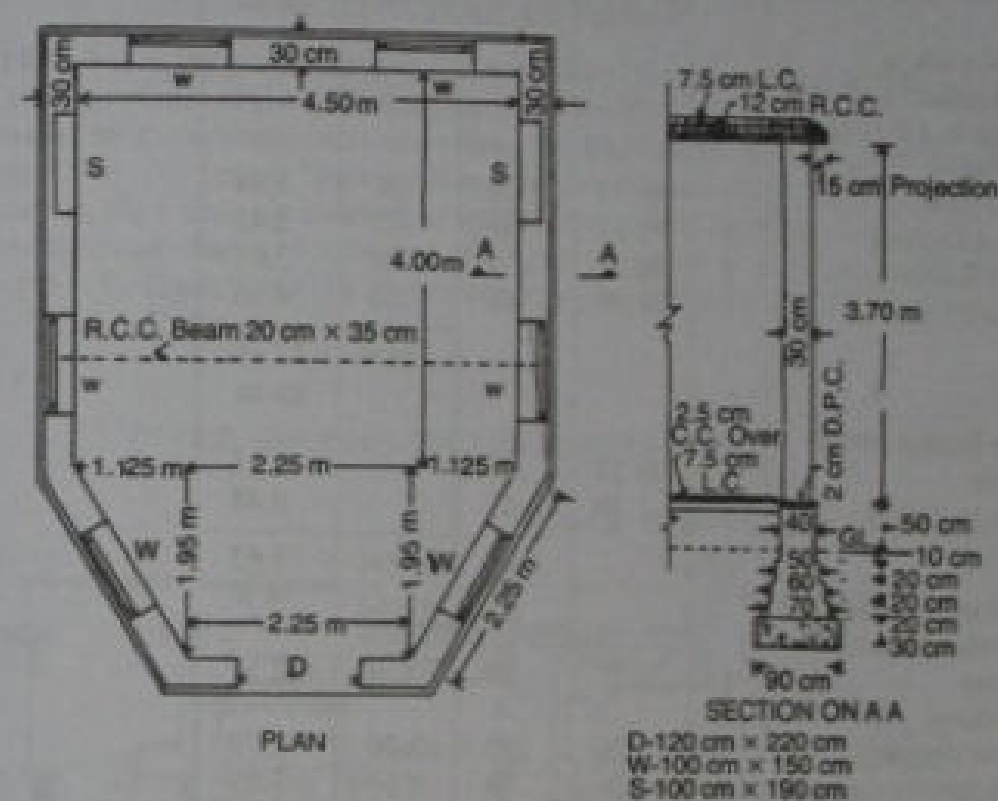

Fig. 3-13

Centre to centre length of inclined wall

$$\begin{aligned}
 &= \sqrt{(1.95 + .15)^2 + (1.125 + .15)^2} \\
 &= \sqrt{(2.1)^2 + (1.275)^2} \\
 &= \sqrt{6.04} = 2.46 \text{ m (approximately).}
 \end{aligned}$$

Total centre line length of walls = 4.80 + (2 × 4.15) + (2 × 2.46) + 2.25 = 20.27 m.

The centre length of front half hexagonal portion may be calculated by trigonometrical method as per Example No. 8 in page 130. But the length as has been found above is sufficient for practical purpose.

Details of Measurement and Calculation of Quantities (Ex. 9)

Item No.	Particulars of items and details of works	No.	Length m	Breadth m	Height or Depth m	Quantity	Explanatory notes
1.	Earthwork in foundation ...	1	20.27	.90	.90	16.42 cu m	} L = Total centre length = 20.27 m
2.	Concrete in foundation ...	1	20.27	.90	.30	5.47 cu m	
3.	Brickwork in foundation and plinth in 1:6 cement mortar—						
	1st footing ...	1	20.27	.70	.20	2.84	
	2nd footing ...	1	20.27	.60	.20	2.43	
	3rd footing ...	1	20.27	.50	.20	2.03	
	Plinth wall ...	1	20.27	.40	.60	4.86	
					Total	12.16 cu m	
4.	2 cm Damp proof course ...	1	20.27	.40	—	8.11	
	Deduct door sill ...	1	1.20	.40	—	0.48	
				Net	Total	7.63 sq m	
5.	Brickwork in superstructure in lime mortar	1	20.27	.30	3.70	22.50	
	Deduct —						
	Door opening ...	1	1.20	.30	2.20	0.79	
	Window openings ...	6	1.00	.30	1.50	2.70	
	Shelf ...	2	1.00	.20	1.90	0.76	
	Lintel over door ...	1	1.44	.30	.10	0.043	} 10 cm thick lintel } 12 cm bearing
	Lintel over windows ...	6	1.24	.30	.10	0.223	
	Lintel over shelf ...	2	1.24	.30	.10	0.074	
				Total deduction		4.59	
				Net	Total	17.91 cu m	
6.	2.5 cm c. c. over 7.5 cm lime concrete floor						
	Rectangular portion	1	4.50	4.00	—	18.00	
	Front half hexagonal portion	1	$\frac{4.50 + 2.25}{2} \times 1.95$	—	—	6.58	
	Door sill ...	1	1.20	.35	—	0.42	} Only 2.5 cm c.c.
					Total	25.00 sq m	

ABSTRACT OF QUANTITIES Ex. 9

1. Earthwork in foundation	—	16.42 cu m
2. Concrete in foundation	—	5.47 cu m
3. Brickwork in foundation and plinth in 1:6 cement mortar	—	12.16 cu m
4. 2 cm Damp proof course	—	7.63 sq m
5. Brickwork in superstructure in lime mortar	—	17.91 cu m
6. 2.5 cm c.c. over 7.5 cm lime concrete floor	—	25.00 sq m

### ESTIMATE OF AN OFFICE BUILDING, ONE OF THE ROOM HAVING SEMI-CIRCULAR FRONT

**Example 10.** — From the given plan, elevation and section of an office building Figs. 3-14 and 3-15 work out the quantities of the following items of work:—

(1) Earthwork in excavation in foundation, (2) Earthwork in filling in plinth, (3) Lime concrete in foundation, (4) I-class Brickwork in foundation and plinth in lime mortar, (5) 2.5 cm Damp proof course, (6) I-class Brickwork in superstructure in lime mortar, (7) R.C.C. work in beam, roof including sun shades, lintels, etc., (8) Lime concrete in roof terracing, (9) 2.5 cm c.c. 1:2:4 over 7.5 cm L.C. floor, and (10) 12 mm cement plastering 1:6 inside and outside walls.

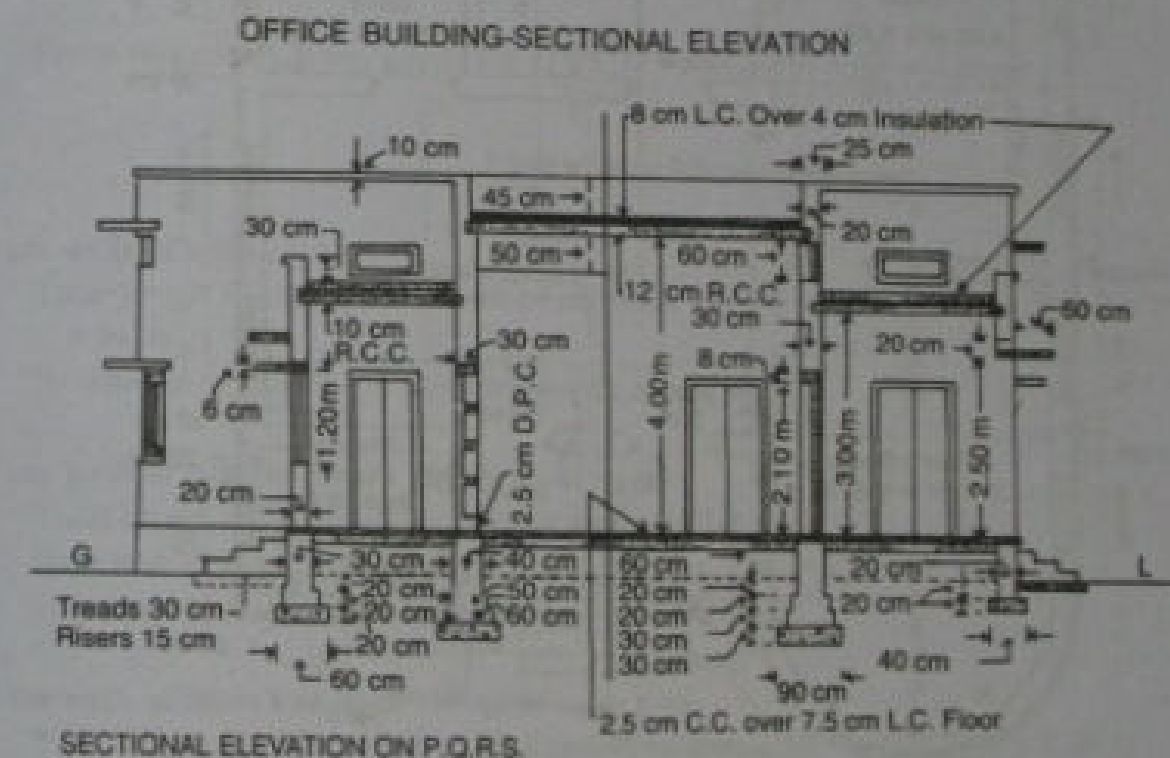
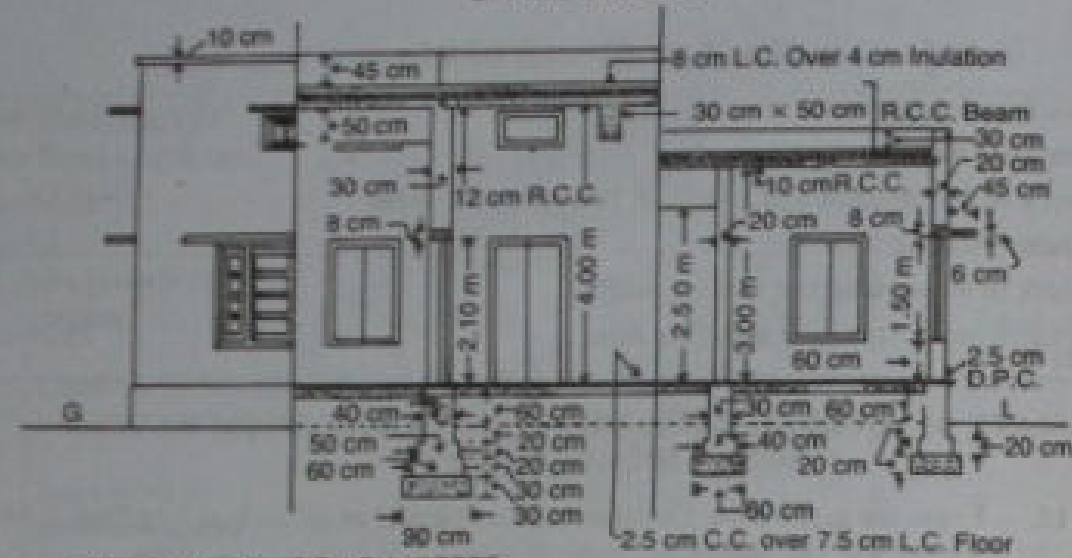
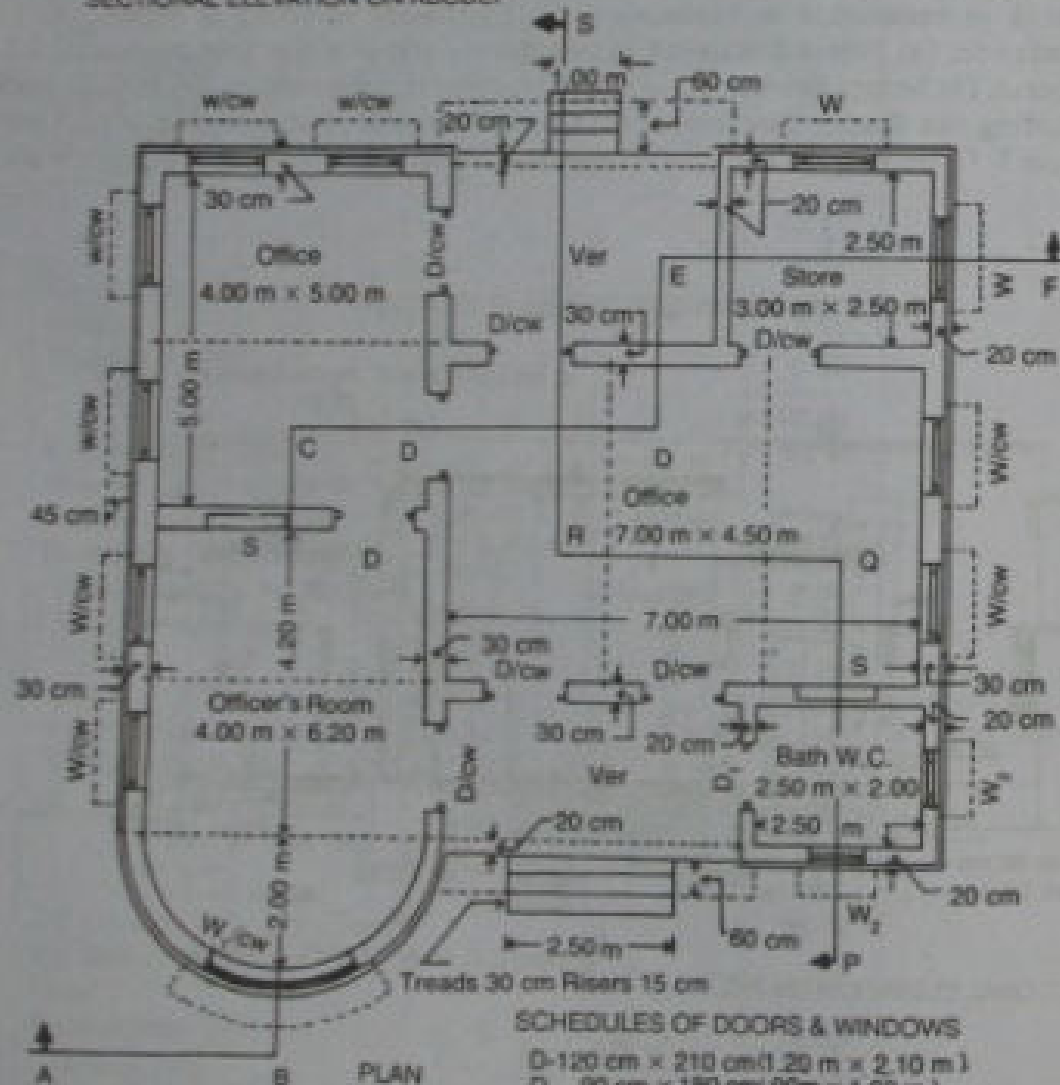

Fig. 3-14

## OFFICE BUILDING



SECTIONAL ELEVATION ON ABCDEF



## SCHEDULES OF DOORS &amp; WINDOWS

- D-120 cm x 210 cm (1.20 m x 2.10 m)  
 D<sub>1</sub> 90 cm x 180 cm (90 cm x 1.80 m)  
 W-110 cm x 150 cm (1.10 m x 1.50 m)  
 W<sub>1</sub> 200 cm x 150 cm (2.00 m x 1.50 m)  
 W<sub>2</sub> 75 cm x 120 cm (75 cm x 1.20 m)  
 C.W.-100 cm x 60 cm (1.00 m x 60 cm)  
 S-120 cm x 200 cm (1.20 m x 2.00 m)

Fig. 3-15

## Centre to Centre Length of Walls—(Ex. 10)

Officer's room and left hand office room combined (30 cm wall) —

$$\text{Long walls c. to c.} = 5.00 + 4.20 + .3 + .15 = 9.65 \text{ m}$$

$$\text{Short walls c. to c.} = 4.00 + .30 = 4.30 \text{ m}$$

$$\text{Semi circular wall c. to c.} = \pi r = \frac{22}{7} \times 2.15 = 6.757 \text{ m} = 6.76 \text{ m}$$

Office room right side (30 cm wall) —

$$\text{Long walls c. to c.} = 7.00 + .30 = 7.30 \text{ m}$$

$$\text{Short walls c. to c.} = 4.50 + .30 = 4.80 \text{ m}$$

Short room (20 cm wall) —

$$\text{Back wall c. to c.} = 3.00 + .20 = 3.20 \text{ m}$$

$$\text{Side wall c. to c.} = 2.50 + \frac{.20}{2} + \frac{.30}{2} = 2.75 \text{ m}$$

Bath and W.C. (20 cm wall) —

$$\text{Front wall c. to c.} = 2.50 + .20 = 2.70 \text{ m}$$

$$\text{Side wall c. to c.} = 2.00 + \frac{.20}{2} + \frac{.30}{2} = 2.25 \text{ m}$$

$$\text{Back verandah (20 cm wall) c. to c.} = 7.30 - 3.40 + \frac{.20}{2} + \frac{.30}{2} = 4.15 \text{ m}$$

$$\text{Front verandah (20 cm wall) c. to c.} = 7.30 - 2.90 + \frac{.20}{2} + \frac{.30}{2} = 4.65 \text{ m}$$

## Total Centre Line Length

30 cm walls of main rooms —

$$\text{Total length of centre lines of all 30 cm walls} = 2 \times 9.65 + 2 \times 4.30 + 6.76 + 2 \times 7.30 + 4.80 = 54.06 \text{ m}$$

$$\text{Number of junctions} = 4 \text{ (Junctions with 30 cm wall)}$$

20 cm walls of store and bath and W.C. —

$$\text{Total length of centre lines of 20 cm walls of Store and Bath and W.C.} = (3.20 + 2 \times 2.75) + (2.70 + 2 \times 2.25) = 15.90 \text{ m}$$

$$\text{Number of junctions} = 4 \text{ (Junctions with 30 cm wall)}$$

20 cm walls of front and back verandah —

$$\text{Total length of centre lines of 20 cm walls of verandah} = 4.65 + 4.15 = 8.80 \text{ m}$$

$$\text{Number of junctions} = 4 \text{ (Two junctions with 30 cm wall and two junctions with 20 cm wall)}$$

*Note.*— Estimate of this example (Ex. 10) has been solved by centre line method in the following pages.

## OFFICE BUILDING

## Details of Measurement and Calculation of Quantities (Ex. 10)

Item No.	Particulars of items and details of works	No.	Length m	Breadth m	Height or Depth m	Quantity	Explanatory notes
1.	<b>Earthwork in excavation in foundation</b>						
	30 cm walls of Main rooms	1	52.26	.90	1.00	47.034	$L = 54.06 - 4 \times \frac{.90}{2} = 52.26 \text{ m}$
	20 cm walls of Store and Bath and W.C.	1	14.10	.60	.60	5.076	$L = 15.90 - 4 \times \frac{.90}{2} = 14.10 \text{ m}$
	20 cm walls of front and back verandah	1	7.30	.40	.40	1.168	$L = 8.80 - 2 \times \frac{.90}{2} - 2 \times \frac{.60}{2} = 7.30 \text{ m}$
	Step front	1	2.70	1.00	.15	0.405	
	Step back	1	1.20	1.00	.15	0.180	
					Total	53.863	cu m
2.	<b>Earthwork in filling in plinth—</b>						
	Officer's rooms	1	4.15	3.90	.525	8.497	Ht. = 60 cm - 7.5 cm = 52.5 cm = .525 m
	Semi-circular portion	1	$\frac{1}{2} \pi \times (1.95)^2$		.525	3.134	
	Office room left	1	4.90	3.90	.525	10.033	
	Office room right	1	6.90	4.40	.525	15.939	
	Store room	1	2.90	2.40	.525	3.654	
	Bath and W.C.	1	2.40	1.90	.525	2.394	
	Verandah front	1	4.30	1.95	.525	4.402	
	Verandah back	1	3.80	2.45	.525	4.888	
					Total	52.941	cu m
3.	<b>Lime concrete in foundation</b>						
	30 cm walls	1	52.26	.90	.30	14.110	L same as for excavation
	20 cm walls of store and bath and W.C.	1	14.70	.60	.20	1.764	$L = 15.90 - 4 \times \frac{.60}{2} = 14.70 \text{ m}$
	20 cm walls of front and back verandah	1	7.90	.40	.20	0.632	$L = 8.80 - 2 \times \frac{.90}{2} - 2 \times \frac{.40}{2} = 7.90 \text{ m}$
	Step front	1	2.70	1.00	.15	0.405	
	Step back	1	1.20	1.00	.15	0.180	
					Total	17.091	cu m

(Ex. 10 Contd.)

Item No.	Particulars of items and details of works	No.	Length m	Breadth m	Height or Depth m	Quantity	Explanatory notes
4.	<b>I-class brick-work in foundation and plinth in lime mortar—</b>						
	30 cm walls — 1st footing	1	52.86	.60	.30	9.515	$L = 54.06 - 4 \times \frac{.60}{2} = 52.86 \text{ m}$
	2nd footing	1	53.06	.50	.20	5.306	$L = 54.06 - 4 \times \frac{.50}{2} = 53.06 \text{ m}$
	Plinth wall	1	53.26	.40	.80	17.043	$L = 54.06 - 4 \times \frac{.40}{2} = 53.26 \text{ m}$
	Note — Length of 2nd and subsequent footings can be obtained by adding .20 m ( $4 \times .05$ ) to first footing length.						
	20 cm walls of store and bath—						
	Footing	1	14.90	.40	.20	1.192	$L = 15.90 - 4 \times \frac{.50}{2} = 14.90 \text{ m}$
	Plinth wall	1	15.10	.30	.80	3.624	$L = 15.90 - 4 \times \frac{.40}{2} = 15.10 \text{ m}$
	20 cm walls of verandah—Dwarf plinth wall	1	8.10	.20	.80	1.296	$L = 8.80 - 2 \times \frac{.40}{2} - 2 \times \frac{.30}{2} = 8.10 \text{ m}$
	Step front	1	2.50	.60	.45	0.675	Average breadth
	Step back	1	1.00	.60	.45	0.270	
					Total	38.921	cu m
5.	<b>2.5 cm Damp proof course—</b>						
	30 cm walls	1	53.26	.40	—	21.304	Length same as plinth wall.
	30 cm walls of store and bath	1	15.10	.30	—	4.530	
					Total	25.834	sq m
	<b>Deduct door openings—</b>						
	Doors D	8	1.20	.40	—	3.840	
	Doors D <sub>1</sub>	1	.90	.30	—	0.270	
					Total	4.110	sq m
					Net	21.724	sq m

Item No.	Particulars of items and details of works	No.	Length m	Breadth m	Height or Depth m	Quantity	Explanatory notes
	Right side room ...	1	7.40	4.70	B.F.	47.25	
	Front verandah and bath ...	1	7.10	2.00	—	34.78	
	Back verandah and store ...	1	7.10	2.50	—	14.20	
					Total	17.75	
						113.98	
						sq m	
9.	2.5 cm c.c. 1:2:4 over and including 7.5 cm L.C. floor—						
	Officer's room ...	1	4.20	4.00	—	16.80	Note: Sills of doors and sills of verandah opening over dwarf walls which consists of only 2.5 cm c.c., have not been included.
	Semi-circular portion ...	1	$\frac{1}{2}\pi \times 2^2$	—	—	6.29	
	Office left ...	1	5.00	4.00	—	20.00	
	Office right ...	1	7.00	4.50	—	31.50	
	Store ...	1	3.00	2.50	—	7.50	
	Bath ...	1	2.50	2.00	—	5.00	
	Verandah back ...	1	3.90	2.50	—	9.75	
	Verandah front ...	1	4.40	2.00	—	8.80	
					Total	105.64	
						sq m	
10.	12 mm cement plastering 1:6 in walls—						
	Officer's room ...	1	18.70	—	4.00	74.80	Total L = 4.00 + 2 × 4.20 + $\pi \times 2.00 = 18.70$ m
	Office left (4 walls) ...	1	18.00	—	4.00	72.00	
	Office right (4 walls) ...	1	23.00	—	4.00	92.00	
	Store (4 walls) ...	1	11.00	—	3.00	33.00	
	Bath (4 walls) ...	1	9.00	—	3.00	27.00	
	Verandah front (3 walls) ...	1	8.40	—	3.00	25.20	
	Verandah back (3 walls) ...	1	9.40	—	3.00	28.20	
					C.O.	352.20	

Note.—Insulation layer got the same area as in item 8.

(Ex. 10 Contd.)

Item No.	Particulars of items and details of works	No.	Length m	Breadth m	Height or Depth m	Quantity	Explanatory notes
	Verandah front above opening ...	1	4.40	—	B.F.	352.20	
	Verandah back above opening ...	1	3.90	—	.50	2.20	
	Jamb, sill, soffit of shelf ...	2	6.40	.20	—	1.95	
	Jamb of walls below verandah lintel ...	4	—	.20	2.50	2.56	
	Outside—						
	Left side outer walls full height G.L. to top of parapet including 10 cm below G.L. ...	1	21.60	—	5.40	116.64	Total L = 4.60 + 9.80 + $\pi \times 2.3 = 21.60$ m
	Right outer wall of room, height as above ...	1	5.10	—	5.40	27.54	
	Outer walls short (2 walls) height as above ...	1	6.10	—	4.22	25.74	L = 3.40 + 2.70 = 6.10 m
	Outer walls bath (2 walls) height as above ...	1	5.10	—	4.22	21.52	L = 2.90 + 2.20 = 5.10 m
	Verandah front above opening ...	1	4.40	—	1.02	4.49	Up to top of parapet.
	Verandah back above opening ...	1	3.90	—	1.02	3.98	
	Front verandah plinth excluding step ...	1	1.90	—	.70	1.33	Including 10 cm below G.L.
	Back verandah plinth excluding step ...	1	2.90	—	.70	2.03	
	Main wall above lower roof— Front and back ...	2	7.30	—	1.47	21.46	Ht = 4.69 - 3.22 = 1.47 m
	Parapet top and inner face—						
	Over main rooms ...	1	44.76	—	.70	31.33	Length as in item 6.
	Outer verandah and side rooms ...	1	19.10	—	.55	10.51	
					Total	627.48	sq m

Item No.	Particulars of items and details of works	No.	Length m	Breadth m	Height or Depth m	Quantity	Explanatory notes
<b>Deduct openings —</b>							
<b>Door —</b>							
D	—	8	1.20	—	2.10	20.16	One face.
D <sub>1</sub>	—	1	.90	—	1.80	1.62	
<b>Windows —</b>							
W	—	10	1.10	—	1.50	16.50	
W <sub>1</sub>	—	1	2.00	—	1.50	3.00	
W <sub>2</sub>	—	2	.75	—	1.20	1.80	
CW	—	15	1.00	—	.60	9.00	
		Total of deduction				52.08 sq m	
		Net		Total		575.40 sq m	

#### ABSTRACT OF QUANTITIES (Ex. 10)

1. Earthwork in excavation in foundation	...	53.863 cu m
2. Earthwork in filling in plinth	...	52.941 cu m
3. Lime concrete in foundation	...	17.091 cu m
4. I-class brickwork in lime mortar in foundation and plinth	...	38.921 cu m
5. 2.5 cm Damp proof course	...	21.724 sq m
6. I-class Brickwork in superstructure in lime mortar	...	65.206 cu m
7. R.C.C. work including steel in beam, roof, lintel, sunshades, etc.	...	19.278 cu m
8. 8 cm Lime concrete roof terracing	...	113.98 sq m
9. 2.5 cm c.c. 1:2:4 over and including 7.5 cm L.C. floor	...	105.64 sq m
10. 12 mm cement plastering 1:6 in walls	...	575.40 sq m

Note.— Students may estimate the remaining items of this example.

#### FOUNDATION PLAN OF SHOP BUILDING (Ex. 11)

See Example 11 and Figs. 3-17 and 3-18 in pages 146-147.

Fig. 3-16 is the plan of the shop building, earth removed, showing the foundation footings, walls, etc., which will help the beginners to understand and to take out the dimensions of different walls and footings.

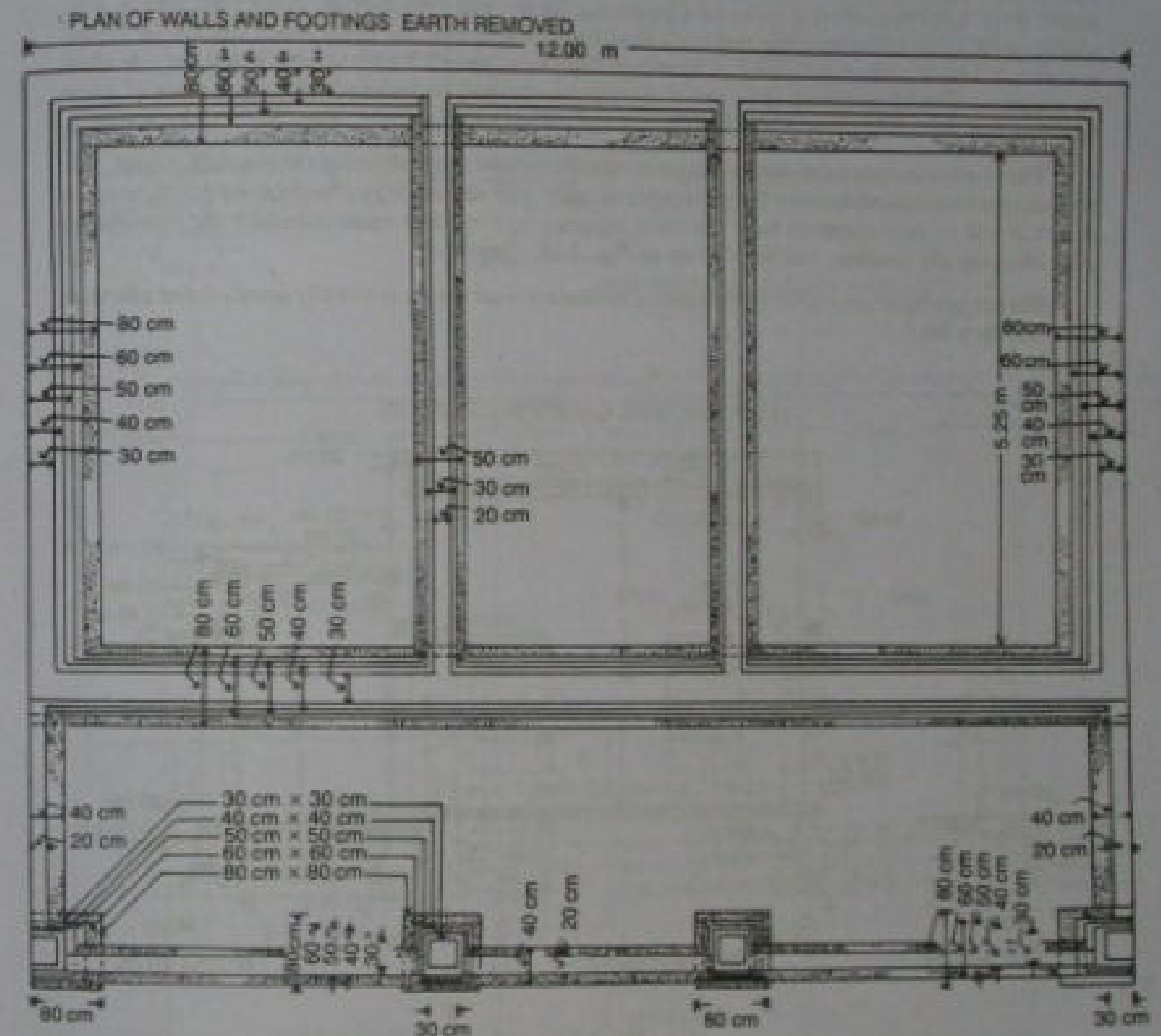

Fig. 3-16

**ESTIMATE OF A SHOP BUILDING WITH WALLS ABUTTING BOUNDARY LAND**

**Example 11.** — Prepare a detailed estimate of a shop building consisting of three shops with front verandah from the given drawing (Figs. 3-17 and 3-18). The general specifications are as follows:—

Foundation concrete shall be of lime concrete. Foundation and plinth masonry shall be of first class brickwork in 1 : 6 cement sand mortar. 2.5 cm c.c. Damp proof course shall be provided at the plinth level. Superstructure shall be of first class brickwork in lime mortar. Roof slab, lintels, etc. shall be of R.C.C. Lime concrete terracing shall be provided over the roof. Floor shall be of 2.5 cm c.c. over 7.5 cm lime concrete. Sills of openings shall be of only 2.5 cm c.c. Inside and outside shall be plastered with 12 mm thick 1 : 6 cement mortar. Inside shall be finished with three coats of white washing and outside finished with the two coats of colour washing over one coat of white washing.

This is a typical problem with walls on the back and two sides abutting the boundary land. The foundation footings of these walls are on one side only. For estimating of foundation portions up to plinth it will be convenient to take the walls separately. For clear understanding the foundation plan showing the footings has been given in Fig. 3-16, page 145.

Similar problem may arise in the case of boundary wall which is usually constructed abutting the boundary land.

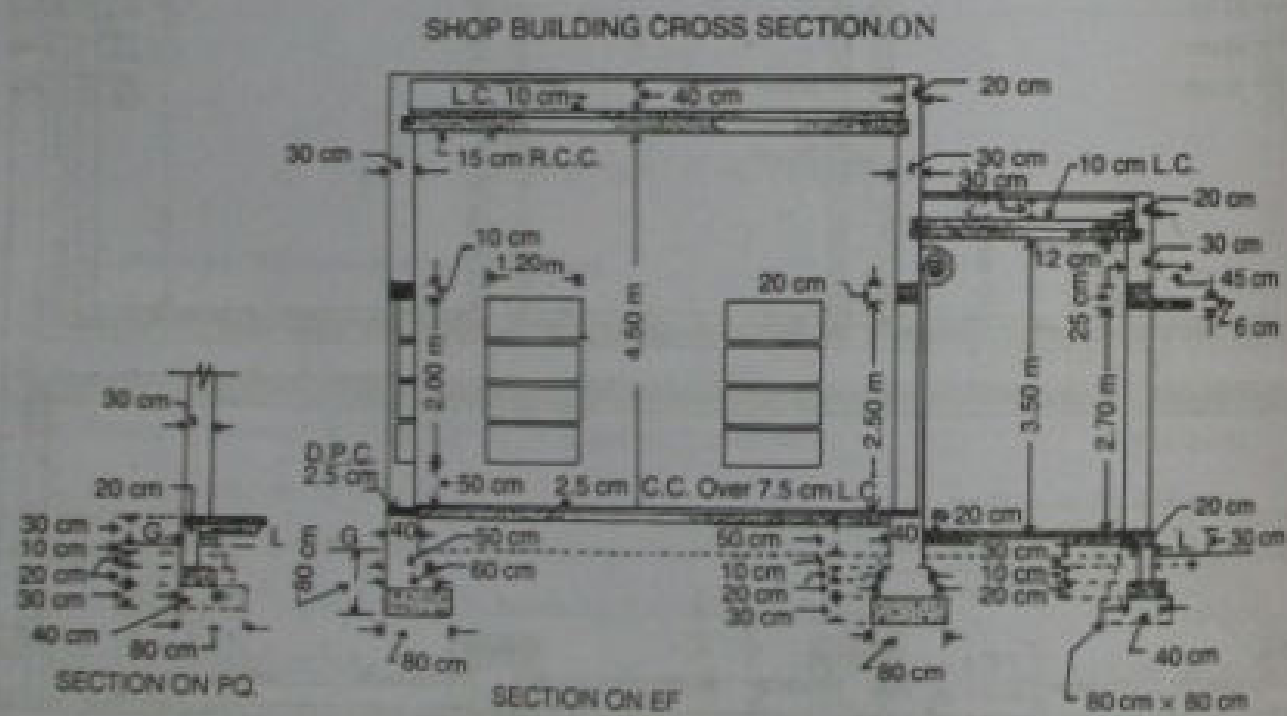

Fig. 3-17

**SHOP BUILDING WALLS ABUTTING BOUNDARY LAND**

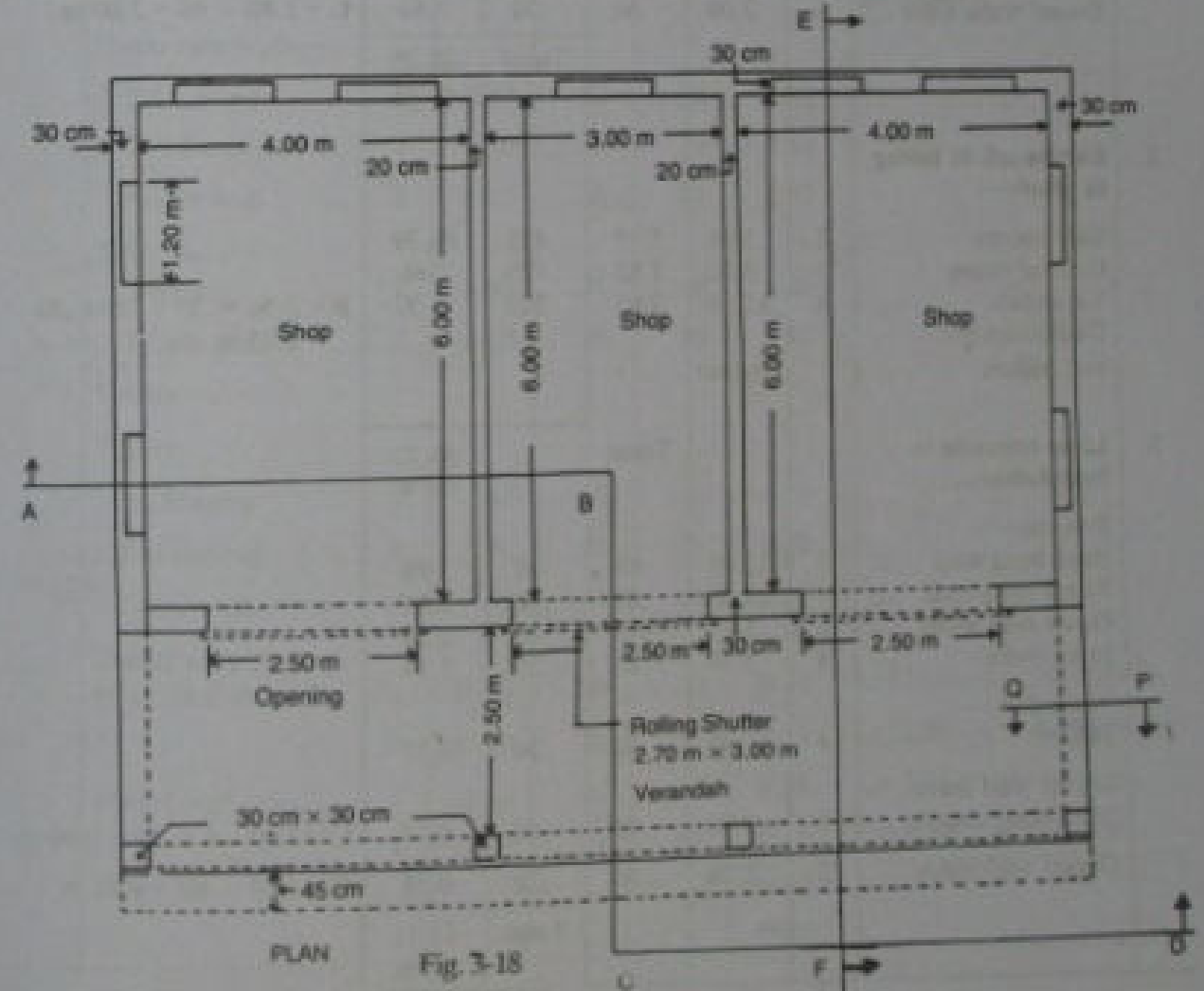
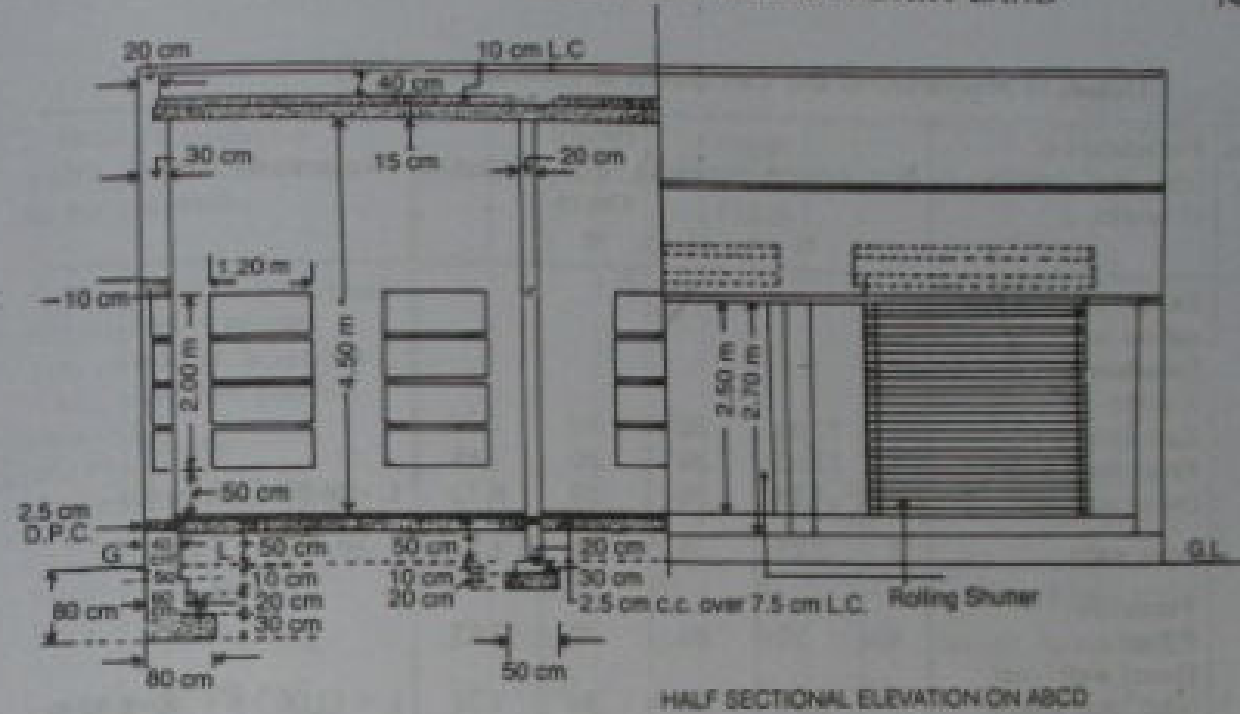

Fig. 3-18



Details of Measurement and Calculation of Quantities (Ex. 11)

Item No.	Particulars of items and details of works	No.	Length m	Breadth m	Height or Depth m	Quantity	Explanatory notes
1.	<b>Earthwork in excavation in foundation—</b>						
	Rooms—						
	Back long wall ...	1	12.00	.80	.80	7.68	
	Front long wall ...	1	12.00	.80	.80	7.68	
	Outer side wall ...	2	5.25	.80	.80	6.72	$L = (6.00 + .30 + \frac{.30}{2})$ $- .80 - \frac{.80}{2} = 5.25 \text{ m}$
	Inter walls ...	2	5.25	.50	.30	1.57	
	Verandah—						
	Pillars ...	4	.80	.80	.80	2.05	
	Dwarf wall front (sum total length) ...	1	8.80	.40	.50	1.76	$L = 12.00 - 4 \times .80 = 8.80 \text{ m}$
	Dwarf walls sides ...	2	2.00	.40	.50	0.80	$L = 2.80 - .80 = 2.00 \text{ m}$
					Total	28.26	cu m
2.	<b>Earthwork in filling in plinth—</b>						
	Side rooms ...	2	3.90	5.85	.425	19.39	
	Central room ...	1	3.00	5.85	.425	7.46	
	Verandah ...	1	11.60	2.65	.225	6.92	$B = 2.50 + .30 + .05 - .20$ $= 2.65 \text{ m}$
	Deduction for ver. pillars ...		Neglect				
					Total	33.77	cu m
3.	<b>Lime concrete in foundation—</b>						
	Rooms—						
	Back long wall ...	1	12.00	.80	.30	2.88	
	Front long wall ...	1	12.00	.80	.30	2.88	
	Outer side walls ...	2	5.25	.80	.30	2.52	
	Inter walls ...	2	5.70	.50	.20	1.14	
	Verandah—						
	Pillars ...	4	.80	.80	.30	0.77	
	Dwarf wall front (sum total length) ...	1	9.60	.40	.20	0.77	$L = 12.00 - 4 \times .60 = 9.60 \text{ m}$
	Dwarf wall sides ...	2	2.20	.40	.20	0.35	$L = 2.80 - .60 = 2.20 \text{ m}$
					Total	11.31	cu m

(Ex. 11 Contd.)

Item No.	Particulars of items and details of works	No.	Length m	Breadth m	Height or Depth m	Quantity	Explanatory notes
4.	<b>1st class brick-work in 1:6 cement mortar in foundation and plinth—</b>						
	Rooms—						
	Front and back walls—						
	1st footing ...	2	12.00	.60	.20	2.88	Front and back walls
	2nd footing ...	2	12.00	.50	.20	2.40	though dis-similar in
	Plinth wall ...	2	12.00	.40	.60	5.76	section, their dimensions
							are same.
	Outer side walls—						
	1st footing ...	2	5.55	.60	.20	1.33	
	2nd footing ...	2	5.70	.50	.20	1.14	
	Plinth wall ...	2	5.85	.40	.60	2.81	
	Inter walls—						
	Footing ...	2	5.85	.30	.10	0.35	
	Plinth wall ...	2	5.85	.20	.50	1.17	
	Verandah—						
	Pillars—						
	1st footing ...	4	.60	.60	.20	0.29	
	2nd footing ...	4	.50	.50	.20	0.20	
	Plinth wall ...	4	.40	.40	.40	0.26	
	Dwarf wall front (sum total length) ...	1	10.00	.20	.20	0.40	$L = 12.00 - 4 \times .50 = 10.00 \text{ m}$
		1	10.40	.20	.40	0.83	$L = 12.00 - 4 \times .40 = 10.40 \text{ m}$
	Dwarf wall sides ...	1	2.30	.20	.20	0.09	$L = 2.80 - .50 = 2.30 \text{ m}$
		1	2.40	.20	.40	0.19	$L = 2.80 - .40 = 2.40 \text{ m}$
					Total	20.10	cu m

Item No.	Particulars of items and details of works	No.	Length m	Breadth m	Height or Depth m	Quantity	Explanatory notes
5.	<b>2.5 cm c.c. Damp proof course—</b>						
	Rooms—						
	Back and front walls	2	12.00	.40	—	9.60	
	Outer side walls	2	5.85	.40	—	4.68	
	Inter walls	2	5.85	.20	—	2.34	
	Verandah pillars	4	.40	.40	—	0.64	
						Total	17.26
	Deduct sills of gate	3	2.50	.40	—	3.00	
				Net	Total	14.26	sq m
6.	<b>I-class brick-work in super-structure in lime mortar —</b>						
	Rooms front, back and outer side walls	1	36.00	.30	4.50	48.60	Total length of outer walls = $2 \times 12 + 2 \times 6 = 36.00$ m
	Inter walls	2	6.00	.20	4.50	10.80	
	Verandah —						
	Pillars	4	.30	.30	2.70	0.97	
	Walls above lintel over pillar, front and sides	1	17.00	.30	.55	2.81	Total length = $12 + 2 \times 2.50 = 17.00$ m
	Parapet, rooms total length	1	36.40	.20	.65	4.73	$L = 2 \times 12 + 2 \times 6.20 = 36.40$ m
	Parapet, verandah total length	1	17.20	.20	.52	1.79	$L = 12 + 2 \times 2.60 = 17.20$ m
						Total	69.70
	<b>Deduct —</b>						
	Gate openings	3	2.50	.30	2.50	5.63	
	Shelf openings	9	1.20	.20	0.20	0.43	
	Lintels over gates	3	2.80	.30	.20	0.50	Bearing 15 cm
	Lintels over shelf	9	1.40	.30	.10	0.38	Bearing 10 cm
						Total	6.94
				Net	Total	62.76	cu m

Item No.	Particulars of items and details of works	No.	Length m	Breadth m	Height or Depth m	Quantity	Explanatory notes
7.	<b>R.C.C. work including steel and its bending but including centering, shuttering and binding steel—</b>						
	Room roof slab	1	11.60	6.20	.15	10.78	Bearing 10 cm
	Verandah roof slab	1	11.60	2.70	.12	3.75	
	Lintel over gates	3	2.80	.30	.20	0.50	
	Lintel over shelf	9	1.40	.30	.10	0.37	
	Verandah lintel front and sides	1	17.40	.30	.25	1.30	Total length including 20 cm bearing on walls of rooms.
	Front chujja	1	12.00	.45	.06	0.32	
						Total	17.02
						cu m	
8.	<b>Mild steel work including bending in reinforcement bars @ 9%</b>						
						$\frac{0.9 \times 17.02}{100} \times 78.5 = 12.02$	Density of mild steel = 78.5 q/cu m
9.	<b>10 cm lime concrete terracing—</b>						
	Room	1	11.60	6.20	—	71.92	
	Verandah	1	11.60	2.70	—	31.32	
						Total	103.24
						sq m	
10.	<b>12 mm thick cement plastering 1 : 6 in walls —</b>						
	Inside						
	Side room 4 walls	2	20.00	—	4.50	180.00	Inside perimeter
	Central room 4 walls	1	18.00	—	4.50	81.00	
	Verandah —						
	Wall of rooms	1	11.40	—	3.50	39.90	
	Front and side wall above pillars	1	16.40	—	.80	13.12	$L = 11.40 + 2 \times 2.50 = 16.40$ m
	Pillars' inner faces	12	—	.30	2.70	9.72	3 faces of central, 2 faces of outer pillars and 2 faces of wall.
	Jambs of shelf	9	6.40	.20	—	11.52	Total length of jambs, sills and soffits.
						C.O.	335.26

Item No.	Particulars of items and details of works	No.	Length m	Breadth m	Height or Depth m	Quantity	Explanatory notes
					B.F.	335.26	
	Jambs and soffits of gates	3	7.50	.30	—	6.75	Total length of 2 jambs and 1 soffits.
	Soffit of ver. lintel front and sides	1	15.80	.30	—	4.74	$L = 11.40 + 2 \times 2.50 - 2 \times .30 = 15.80$ m
	Deduct gate openings	3 × 2	2.50	—	Total 2.50	37.50	Both sides.
				Total of inside		309.25	sq m
	Outside — Rooms back and sides including 10 cm below G.L.	1	25.20	—	5.75	144.90	$L = 12.00 + 2 \times 6.60 = 25.20$ m $Ht. = 4.50 + .65 + .50 + .10 = 5.75$ m
	Front wall above verandah roof	1	12.00	—	1.63	19.56	$Ht. = 4.50 - 3.52 + .25 + .40 = 1.63$ m
	Verandah front and side above pillars	1	17.60	—	1.32	23.23	$L = 12.00 + 2 \times 2.80 = 17.60$ m $Ht. = .80 + .22 + .30 = 1.32$ m
	Verandah plinth wall front and sides	1	17.70	—	0.40	7.08	Including 10 cm below G.L.
	Parapet over rooms, inner faces	1	35.60	—	0.40	14.24	$L = 2 \times 11.60 + 2 \times 6.20 = 35.60$ m
	Parapet over rooms, top	1	36.40	.20	—	7.28	
	Parapet verandah inner faces	1	16.80	—	0.30	5.04	$L = 11.60 + 2 \times 2.60 = 16.80$ m
	Parapet verandah top	1	17.20	.20	—	3.44	
				Total of outside		224.77	sq m
		Total of inside and outside				534.02	sq m
11.	2.5 cm c.c. over and including 7.5 cm L.C. floor—						
	Side rooms	2	4.00	6.00	—	48.00	
	Central room	1	3.00	6.00	—	18.00	
	Verandah	1	11.60	2.60	—	30.16	
				Total		96.16	sq m

Item No.	Particulars of items and details of works	No.	Length m	Breadth m	Height or Depth m	Quantity	Explanatory notes
12.	2.5 cm c.c. floor—						
	Sills of gate	3	2.50	.30	—	2.25	
	Sills of verandah opening over 20 cm dwarf wall	1	15.80	.20	—	3.16	$L = (12.00 - 4 \times .30) + 2 \times 2.50 = 15.80$ m
				Total		5.41	sq m
13.	Steel rolling shutters of 18 gauge of inter-locked laths complete with shaft, spring encasing box, push and pull operations, inside and outside locking arrangements and all other fittings	3	2.70	—	3.00	24.30	sq m
14.	White washing 3 coats inside —						
	Inside walls	Same as inside plastering				309.25	
	Ceiling side rooms	2	4.00	6.00	—	48.00	
	Ceiling central room	1	3.00	6.00	—	18.00	
	Verandah	1	11.40	2.50	—	28.50	
	Soffits of Chujja	1	12.00	0.45	—	5.40	
				Total		409.15	sq m
15.	Colour washing 2 coats over one coat of white washing						
	Outside walls	Same as outside plaster				224.77	
	Upper surface and edges of chujja	1	12.00	.51	—	6.12	
				Total		230.89	sq m
16.	Painting two coats over a coat of priming —						
	Rolling shutters (corrugated)	6 × 1.25	2.70	—	3.00	60.75	3 × 2 = 6 faces, 1/4 for one face.

## Abstract of Estimated Cost (Ex. 11)

Item No.	Details of items	Quantity	Unit	Rate		Per	Amount	
				Rs.	P.		Rs.	P.
1.	Earthwork in excavation in foundation	28.26	cu m	350.00		% cu m	98.91	
2.	Earthwork in filling in plinth	33.77	cu m	275.00		% cu m	92.87	
3.	Lime concrete in foundation	11.31	cu m	220.00		/ cu m	2488.20	
4.	1-class Brickwork in 1 : 6 cement mortar foundation and plinth	20.10	cu m	320.00		/ cu m	6432.00	
5.	2.5 cm c.c. Damp proof course	14.26	sq m	18.00		/ sq m	256.68	
6.	1-class Brickwork in lime mortar in superstructure	62.76	cu m	320.00		/ cu m	20083.20	
7.	R.C.C. work excluding steel and its bending but including centering and shuttering and binding steel	17.02	cu m	675.00		/ cu m	11488.50	
8.	Mild steel work including bending in reinforcement bars at 9%	12.02	quin-tal	515.00		/ quin-tal	6190.30	
9.	10 cm Lime concrete terracing including surface finishing	103.24	sq m	12.00		/ sq m	1238.88	
10.	12 mm Cement plastering 1 : 6	534.02	sq m	7.10		/ sq m	3791.54	
11.	2.5 cm c.c. over and including 7.5 cm L.C. floor	96.16	sq m	18.65		/ sq m	1793.38	
12.	2.5 cm c.c. floor	5.41	sq m	18.00		/ sq m	97.38	
13.	Steel rolling shutters of 18 gauge of inter-locked laths complete with shafts, spring, encasing box, push and pull operations, inside and outside locking arrangements and all other fittings	24.30	sq m	100.00		/ sq m	2430.00	
14.	White washing 3 coats	409.15	sq m	0.75		/ sq m	306.86	
15.	Colour washing 2 coats over one coat of white washing	230.89	sq m	0.82		/ sq m	189.33	
16.	Painting two coats over one coat of priming	60.75	sq m	10.40		/ sq m	631.80	
				Total			57609.83	
	Add 3% for Contingencies						1728.29	
	Add 2% for Workcharged Establishment						1152.20	
				Grand Total			60490.32	

Plinth Area Rate. — Plinth Area of the building = 12.00 m × 9.40 m = 112.80 sq m.

Plinth Area Rate =  $\frac{\text{Total Cost}}{\text{Plinth Area}} = \frac{\text{Rs. } 60490.32}{112.80 \text{ sq m}} = \text{Rs. } 536.26 \text{ per sq m.}$

Note. — For electrification 8% may be added.

Sometimes walls of a building are constructed with different kinds of mortar, certain portion with rich mortar and certain other portion with weak mortar. The jambs of doors and windows and small pillars in between them, and arches may need rich mortar, and the remaining portions of the brick masonry. For economy sometimes the walls are also constructed with mud mortar except the jambs and sills of doors and windows, the upper one or two layers below roof and lower one or two layers above plinth, arches and verandah pillars which are made with cement mortar or lime mortar. In such cases for estimating, the masonry which forms the mass of the wall is calculated as solid, and the masonry in jambs, sills, upper and lower layers, arches, pillars, etc., are calculated. Then to get the quantity of mass masonry deductions are made from solid masonry for :—

- (i) Masonry in jambs, sills upper and lower layers, etc.,
- (ii) Masonry in arches or lintels,
- (iii) Openings.

The following examples illustrate the method of estimating mixed type walls.

#### BUILDING WITH WALL PARTLY IN MUD MORTAR AND PARTLY IN LIME MORTAR

**Example 12.** — The superstructure of the two-roomed building in Fig. 2-6, page 35, shall consist of second class brickwork in mud mortar with the exception of usual trimmings as jambs, sills, upper two layers below roof and lower two layers above plinth which shall be of second class brickwork in lime mortar.

Estimate the quantities of brickwork in the superstructure.

#### Details of Measurement and Calculation of Quantities (Ex. 12)

Item No.	Particulars of items and details of works	No.	Length m	Breadth m	Height or Depth m	Quantity	Explanatory notes
1.	Second class brickwork in lime mortar—						
	Jambs of doors	2 × 2	0.30	.30	2.40	0.86	L = 1½ brick = 30 cm
	Jambs of windows	4 × 2	0.20	.30	1.50	0.72	L = One brick = 20 cm
	Jambs of shelves	2 × 2	0.20	.30	1.50	0.36	L = One brick = 20 cm
	Sills of windows	4	1.40	.30	.20	0.34	L = Whole length including jambs = 1.00 + 2 × .20 = 1.40 m Ht. = Two layers = 20 cm
	Sills of shelves	2	1.40	.30	.20	0.17	Dimensions same as for window.
	Back of shelves	2	1.00	.10	1.50	0.30	10 cm thick.
					C.O.	2.75	

Item No.	Particulars of items and details of works	No.	Length m	Breadth m	Height or Depth m	Quantity	Explanatory notes
	Upper two layers — Front and back walls ...	2	10.90	.30	B.F. .20	2.75 1.31	
	Outer side walls and inter wall ...	3	6.00	.30	.20	1.08	
	Lower two layers — Back wall ...	1	10.90	.30	.20	0.65	
	Front wall (deducting doors) ...	1	8.50	.30	.20	0.51	L=10.90 - 2 × 1.20=8.50 m
	Outer side walls and inter walls ...	3	6.00	.30	.20	1.08	
					Total	7.38 cu m	
2.	Second class brick-work in mud mortar — Front and back walls as solid ...	2	10.90	.30	4.20	27.47	
	Side and back walls as solid ...	3	6.00	.30	4.20	22.68	
						50.15 cu m	As solid.
	Deduct openings and lintels of door, windows and shelves ...	—	—	—	—	4.40	Same as per details on page 40.
	Deduct second class brick-work in lime mortar		Same quantity as in item 1	above		7.38	
			Total of deduction			11.78	
			Net	Total		38.37 cu m	

Abstract of Quantities (Ex. 13) —

1. Second class brickwork in lime mortar in superstructure ...	7.38 cu m
2. Second class brickwork in mud mortar in superstructure ...	38.37 cu m

SITE OFFICE BLOCK

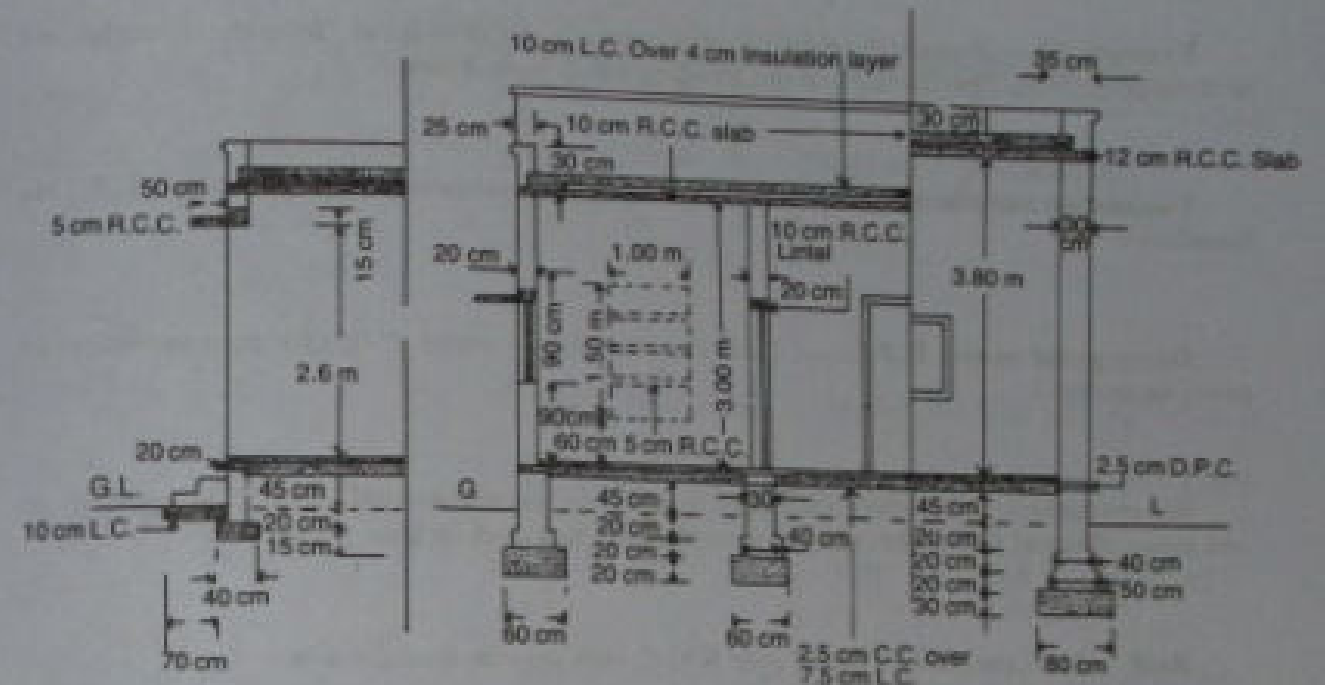

SECTION-PQ

SECTION ELEVATION ON ABCD

- Doors
- D<sub>1</sub>-1.20 × 2.00 m
- D<sub>2</sub>-0.90 × 1.80 m
- Windows
- W<sub>1</sub>-1.00 × 1.20 m
- W<sub>2</sub>-0.75 × 0.90 m
- Shelf-1.00 × 1.50 m
- Steps
- Treads-30 cm
- Rise 15 cm

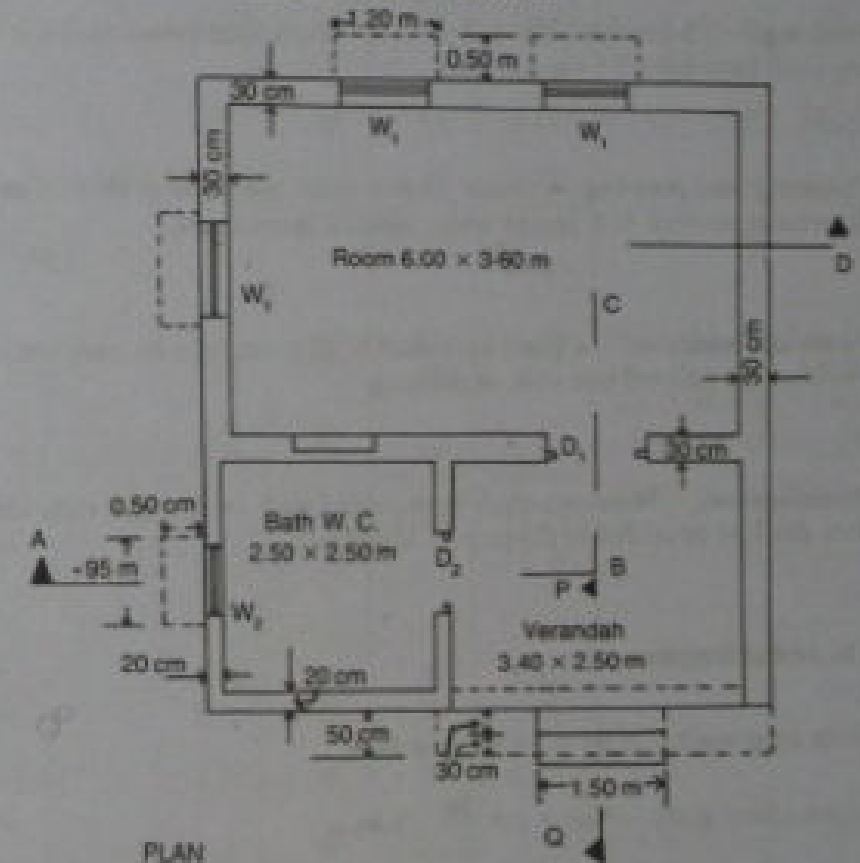

PLAN

Fig. 3-19

CROWKHATS — DOORS = 8 × 12 cm. WINDOWS = 8 × 10 cm.

**Example 13.**— Prepare the detailed estimate of a "Site Office Block" from the given plan and sections (Fig. 3-19). Specification of the building are as given below:—

**Foundation and plinth.**— 2nd class brickwork in lime mortar over cement concrete 1:6:12 in foundation.

**Damp proof course D.P.C.**— 2.5 cm thick cement concrete 1:1½:3 with standard water proofing material.

**Superstructure.**— 2nd class brickwork in mud mortar except usual jambs, sills, upper 10 cm and lower 10 cm of wall which shall be second class brickwork in lime mortar 1:2.

**Roof.**— Lime concrete terracing over R.C.C. slab with an insulation layer.

**Flooring.**— 2.5 cm thick c.c. 1:2:4 over 7.5 cm lime concrete. Sills of doors and verandah opening shall have only 2.5 cm c.c. floor.

**Plastering and pointing**— Inside 12 mm thick plastered with 1:6 cement sand mortar and outside cement pointed 1:3. Inside white washed three coats.

**Doors and windows.**— Chowkhats shall be of salwood part panelled, part glazed. Doors and windows shall be painted one coat of priming.

**Miscellaneous.**— Windows shall be provided with 16 mm dia. mild steel bars. Necessary iron hold fasts shall be provided in doors and windows.

**Centre to centre lengths—**

$$\text{Room long walls} = 6.00 + 2 \times \frac{30}{2} = 6.30 \text{ m}$$

$$\text{Rooms short walls} = 3.60 + 2 \times \frac{30}{2} = 3.90 \text{ m}$$

**Note.**— Special attention shall be given while calculating the centre to centre length of Bath—W.C. and verandah see explanatory notes.

Details of Measurement and Calculation of Quantities (Ex. 13)

Item No.	Particulars of items and details of works	No.	Length m	Breadth m	Height or Depth m	Quantity	Explanatory notes
1.	<b>Earthwork in excavation in foundation—</b>						
	Room—						
	Long walls	2	7.10	.80	.90	10.22	$L = 6.30 + 2 \times \frac{30}{2} = 7.10 \text{ m}$
	Short walls	2	3.10	.80	.90	4.46	$L = 3.90 - 2 \times \frac{30}{2} = 3.10 \text{ m}$
	Bath W.C.—						
	Long walls	1	3.30	.60	.60	1.18	$L = 2.75 + 2 \times \frac{60}{2} = 3.30 \text{ m}$
	Short walls	2	2.00	.60	.60	1.44	$L = 2.75 - \frac{60}{2} - \frac{80}{2} = 2.00 \text{ m}$
	Ver. short walls	1	2.70	.80	.90	1.94	$L = 2.75 - .05 + \frac{80}{2} - \frac{80}{2} = 2.70 \text{ m}$
	Dwarf wall	1	2.95	.40	.35	0.41	$L = 3.65 - \frac{60}{2} - \frac{80}{2} = 2.95 \text{ m}$
	Step	1	1.70	.70	.10	0.12	
					Total	19.78	cu m
2.	<b>Earthwork in filling in plinth—</b>						
	Room	1	6.00	3.60	.375	8.10	Ht. = .45 - .075 = .375 m
	Bath W.C.	1	2.35	2.40	.375	2.11	$L = 2.50 - .10 - .05 = 2.35 \text{ m}$ $B = 2.50 - .10 = 2.40 \text{ m}$
	Verandah	1	3.35	2.50	.375	3.14	$L = 3.40 - .05 = 3.35 \text{ m}$
					Total	13.35	cu m
3.	<b>Lime concrete in foundation—</b>						
	Room long walls	2	7.10	.80	.30	3.41	
	Room short walls	2	3.10	.80	.30	1.49	
	Bath W.C. long wall	1	3.25	.60	.20	0.39	
	Bath W.C. short walls	2	2.15	.60	.20	.85	$L = 2.75 - \frac{80}{2} - \frac{60}{2} = 2.15 \text{ m}$
					C.O.	5.81	

Item No.	Particulars of items and details of works	No.	Length m	Breadth m	Height or Depth m	Quantity	Explanatory notes
					B.F.	5.81	
	Ver. short wall	1	2.70	.80	.30	0.65	
	Dwarf wall	1	3.25	.40	.15	0.20	$B = 3.65 - \frac{.40}{2} - \frac{.40}{2}$
	Step	1	1.70	.70	.10	0.12	$= 3.25 \text{ m}$
					Total	6.78	
						cu m	
4.	II-class brickwork in foundation and plinth— Room—						
	Long wall—						
	1st footing	2	6.80	.50	.20	1.36	$L = 6.30 + 2 \times \frac{.50}{2} = 6.80 \text{ m}$
	2nd footing	2	6.70	.40	.20	1.07	$L = 6.80 - .10 = 6.70 \text{ m}$
	Plinth wall	2	6.60	.30	.65	2.57	$L = 6.70 - .10 = 6.60 \text{ m}$
	Short walls—						
	1st footing	2	3.40	.50	.20	0.68	$L = 3.90 - 2 \times \frac{.50}{2} = 3.40 \text{ m}$
	2nd footing	2	3.50	.40	.20	0.56	$L = 3.40 + .10 = 3.50 \text{ m}$
	Plinth wall	2	3.60	.30	.65	1.40	$L = 3.50 + .10 = 3.60 \text{ m}$
	Bath W.C.—						
	Long wall—						
	1st footing	1	3.05	.40	.20	0.24	$L = 2.70 + 2 \times \frac{.40}{2} = 3.05 \text{ m}$
	Plinth wall	2	3.60	.30	.65	1.40	$L = 3.50 + .10 = 3.60 \text{ m}$
	Short walls—						
	1st footing	2	2.30	.40	.20	0.37	$L = 2.75 - \frac{.40}{2} - \frac{.40}{2} = 2.30 \text{ m}$
	Plinth wall	2	2.40	.30	.65	0.94	$L = 2.30 + .10 = 2.40 \text{ m}$
					C.O.	10.59	

(Ex. 13 Contd.)

Item No.	Particulars of items and details of works	No.	Length m	Breadth m	Height or Depth m	Quantity	Explanatory notes
					B.F.	10.59	
	Ver. Short wall—						
	1st footing	1	2.70	.50	.20	0.27	$L = 2.75 - .05 - \frac{.50}{2} - \frac{.50}{2} = 2.70 \text{ m}$
	2nd footing	1	2.70	.40	.20	0.22	$L = 2.75 - .05 - \frac{.40}{2} - \frac{.40}{2} = 2.70 \text{ m}$
	Plinth wall	1	2.70	.30	.65	0.53	$L = 2.75 - .05 - \frac{.30}{2} - \frac{.30}{2} = 2.70 \text{ m}$
	Dwarf wall	1	3.35	.20	.65	0.44	$L = 3.65 - 2 \times \frac{.30}{2} = 3.35 \text{ m}$
	Step—1st	1	1.50	.60	.15	0.14	
	2nd	1	1.50	.30	.15	0.07	
					Total	12.26	
						cu m	
5.	2.5 cm Damp proof course— Room—						
	Long walls	2	6.60	.30	—	3.96	
	Short walls	2	3.60	.30	—	2.16	
	Bath W.C.—						
	Long walls	1	2.95	.30	—	0.89	
	Short walls	2	2.40	.30	—	1.44	
	Ver. short wall	1	2.70	.30	—	0.81	
					Total	9.26	
	Deduct—						
	Door sill D <sub>1</sub>	1	1.20	.30	—	0.36	
	Door sill D <sub>2</sub>	1	0.90	.20	—	0.18	
					Net	0.54	
					Net	8.72	
					Total	8.72	
						sq m	

Item No.	Particulars of items and details of works	No.	Length m	Breadth m	Height or Depth m	Quantity	Explanatory notes
6.	II-class brickwork in superstructure 10 cm upper and 10 cm lower, jambs and sills, in lime mortar 1:2—						
	Rooms—						
	Long walls	2	6.60	.30	.20	0.79	$L = 6.30 + 2 \times \frac{.30}{2} = 6.60$ m
	Short walls	2	3.60	.30	.20	0.43	$L = 3.90 - 2 \times \frac{.30}{2} = 3.60$ m
	Bath W.C.—						
	Long wall	1	2.90	.20	.20	0.12	Length out to out.
	Short walls	2	2.50	.20	.20	0.20	Length in to in.
	Ver. short wall	1	2.70	.30	.20	0.16	
	Verandah long wall (above lintel)	1	3.40	.20	.10	0.07	
	Jambs—						
	Door D <sub>1</sub>	1 × 2	0.30	.30	1.90	0.34	
	Door D <sub>2</sub>	1 × 2	0.20	.20	1.70	0.14	
	Windows W <sub>1</sub>	3 × 2	0.30	.30	1.20	0.65	
	Windows W <sub>2</sub>	1 × 2	0.20	.20	0.90	0.07	
	Shelf	1 × 2	0.30	.30	1.50	0.27	
	Sills—						
	Windows W <sub>1</sub>	3 × 1	1.00	.30	.10	0.09	
	Windows W <sub>2</sub>	1 × 1	0.75	.20	.10	0.02	
	Shelf	1 × 1	1.00	.30	.10	0.03	
	Back of shelf	1	1.00	.10	1.50	0.15	
					Total	3.53	

Note: Brickwork in lime mortar and mud have been taken separately.

(Ex. 13 Contd.)

Item No.	Particulars of items and details of works	No.	Length m	Breadth m	Height or Depth m	Quantity	Explanatory notes
	Deduct—						
	Door D <sub>1</sub>	1	1.20	.30	.10	0.04	
	Door D <sub>2</sub>	1	0.90	.20	.10	0.02	
					Total	0.06	
				Net	Total	3.47	cu m
7.	II-class brick-work in superstructure in mud mortar—						
	Room—						
	Long walls	2	6.60	.30	3.80	15.05	
	Short walls	2	3.60	.30	3.80	8.21	
	Bath W.C.—						
	Long walls	1	2.90	.20	3.00	1.74	
	Short walls	2	2.50	.20	3.00	3.00	
	Ver. short wall	1	2.70	.30	3.00	2.43	
	Parapet—						
	Over room—						
	Long walls	2	6.60	.30	.44	1.74	Hl. = .30 × .20 × .04 = 0.44 m
	Short walls	2	3.60	.30	.44	0.95	
	Over Bath-W.C. and Verandah—						
	Long wall	1	6.60	.20	.44	0.58	Hl. = .30 × .10 × .04 = 0.44 m
	Short walls	2	2.50	.20	.44	0.44	
					Total	34.14	



Item No.	Particulars of items and details of works	No.	Length m	Breadth m	Height or Depth m	Quantity	Explanatory notes
<b>Deduct —</b>							
<b>Door openings —</b>							
D <sub>1</sub>	1	1.20	0.30	2.00	0.72		
D <sub>2</sub>	1	0.90	0.20	1.80	0.32		
<b>Window openings —</b>							
W <sub>1</sub>	3	1.00	0.30	1.50	1.35		
W <sub>2</sub>	1	0.75	0.20	.90	0.14		
Shelf	1	1.00	0.20	1.50	0.30		
<b>R.C.C. lintel over —</b>							
Door D <sub>1</sub>	1	1.40	0.30	.10	0.042	(a) 10 cm bearing.	
Door D <sub>2</sub>	1	1.10	0.20	.10	0.022	(a)	
Windows W <sub>1</sub>	3	1.20	0.30	.10	0.108	(a) Total of (a) s = 0.227 cu m	
Window W <sub>2</sub>	1	0.95	0.20	.10	0.019	(a)	
Shelf	1	1.20	0.30	.10	0.036	(a)	
<b>Brickwork in lime mortar as in item No. (6)</b>							
						3.47	
						Total	6.53
						Net	Total
							27.61 cu m
8.	R.C.C. work excluding steel and its bending but including centering and shuttering and binding steel fair finished —						
	Roof slab room	1	6.60	4.20	.12	3.33	
	Roof slab Bath-W.C. and Verandah	1	6.60	2.80	.10	1.85	10 cm insertion into 30 cm wall.
						C.O.	5.18

(Ex. 13 Contd.)

Item No.	Particulars of items and details of works	No.	Length m	Breadth m	Height or Depth m	Quantity	Explanatory notes
					B.F.	5.18	
	Lintel over doors windows and shelf	Same as for marked (a) item			item in no. (6)	0.227	
	Verandah lintel	1	3.70	.20	.15	0.111	15 cm insertion into walls.
	Chujia projection verandah front	1	3.90	.50	.05	0.098	
	Sun-sheds over —						
	Windows W <sub>1</sub>	3	1.20	.50	.05	0.090	
	Windows W <sub>2</sub>	1	0.95	.50	.05	0.024	
	Shelf slabs	1 × 2	1.10	.20	.05	0.033	5 cm bearing.
					Total	5.76 cu m	
9.	Mild steel bars including bending in reinforcement @ 1% of R.C.C. works		5.76 × $\frac{1}{100}$	78.5 ×		4.52 q	1% of item no. 8.
10.	10 cm lime concrete in roof terracing —						
	Room	1	6.00	3.60	—	21.60	Clear roof area in between parapet.
	Bath-W.C. and verandah	1	6.20	2.50	—	15.50	
					Total	37.10 sq m	
11.	4 cm thick insulation layer —						
	Room	1	6.00	3.60	—	21.60	
	Bath-W.C. and verandah	1	6.20	2.50	—	15.50	
					Total	37.10 sq m	

Item No.	Particulars of items and details of works	No.	Length m	Breadth m	Height or Depth m	Quantity	Explanatory notes
12.	Salwood work in chowkhat wrought framed and fixed— Doors (3 cm insertion into floor)—						
	D <sub>1</sub> ...	1	5.26	.12	.08	0.051	{ 2 Vert. — 2.03 m each. { 1 Hor. — 1.20 m each. { 2 Vert. — 1.83 m each. { 1 Hor. — 0.90 m each. { 2 Vert. — 1.20 m each. { 2 Hor. — 1.00 m each. { 2 Vert. — 0.90 m each. { 2 Hor. — 0.75 m each.
	D <sub>2</sub> ...	1	4.56	.12	.08	0.044	
	Windows W <sub>1</sub> ...	3	4.40	.10	.08	0.106	
	Windows W <sub>2</sub> ...	1	3.30	.10	.08	0.026	
						Total	0.227 cu m
13.	2.5 cm thick salwood work part panelled and part glazed door and window shutters including fittings—						
	Door D <sub>1</sub> ...	1	1.07	—	1.92	2.05	Rebate 1.5 cm.
	Door D <sub>2</sub> ...	1	0.77	—	1.72	1.32	
	Windows W <sub>1</sub> ...	3	0.87	—	1.07	2.79	
	Windows W <sub>2</sub> ...	1	0.62	—	0.77	0.48	
						Total	
14.	Iron work (mild steel) in hold fasts and window gratings—						
	Hold fasts in doors	2 × 6	—	—	—	12 nos.	6 nos. per door.
	.. .. windows	4 × 4	—	—	—	16 nos.	4 nos. per window.
						Total	28 nos. each 28 kg

(Ex. 13 Contd.)

Item No.	Particulars of items and details of works	No.	Length m	Breadth m	Height or Depth m	Quantity	Explanatory notes
	Window bars 16 mm dia. @ 1.58 kg per m						
	Windows W <sub>1</sub> ...	3 × 7	1.20	—	—	25.20	Vert. bars at 10 cm centres approx.
	Windows W <sub>2</sub> ...	1 × 5	0.90	—	—	4.50	
						29.70 m @ 1.58 kg/m 46.93 kg	
						Total	
15.	12 mm thick plastering inside walls 1:6 cement sand, mortar—						
	Room	2	6.00	—	3.80	45.60	
		2	3.60	—	3.80	27.36	
	Bath-W.C.	4	2.50	—	3.00	30.00	
	Verandah—						
	Back wall	1	3.40	—	3.00	10.20	
	Side walls	2	2.50	—	3.00	15.00	
	Front wall (inside)	1	3.40	—	0.40	1.36	
	Jambs, sills and soffits of shelf	1	5.00	.20	—	1.00	L = 2 × 1.00 + 2 × 1.50 = 5.00 m
	Verandah jambs	2	0.20	—	2.80	1.04	
						Total	131.56
	Deduct—						
	Door openings—						
	D <sub>1</sub> ...	1	1.20	—	2.80	2.40	One face only.
	D <sub>2</sub> ...	1	0.90	—	1.80	1.62	One face only.
						Total	4.02
						Net	Total
							127.54 sq m

Item No.	Particulars of items and details of works	No.	Length m	Breadth m	Height or Depth m	Quantity	Explanatory notes
A.	Cement pointing 1:3 outside—						
	Room— Back wall including 10 cm below G.L. and parapet	1	6.60	—	4.91	32.41	Ht. = 3.80 + .45 + .10 + .12 + .10 + .04 + .30 = 4.91 m
	Side wall including 10 cm below G.L. and parapet	2	4.20	—	4.91	41.24	
	Room front above verandah	1	6.60	—	1.12	7.39	
	Bath-W.C.— Front including 10 cm below G.L.	1	2.90	—	3.99	11.57	Ht. = 3.00 + .45 + .10 + .10 + .04 + .30 = 3.99 m
	Bath-W.C. and ver. Side walls	2	2.70	—	3.99	21.55	
	Verandah— Bottom 10 cm below G.L.	1	3.70	—	0.55	2.04	Ht. = .45 + .10 = .55 m
	Top portion including parapet	1	3.70	—	0.89	3.29	Ht. = .40 + .05 + .10 + .10 + .04 + .30 = 0.89 m
	Parapet— Room—						
	Long walls (inside)	2	6.00	—	.30	3.60	
	Short walls (inside)	2	3.60	—	.30	2.16	
	Top long walls	2	6.60	.35	—	4.62	Out to out.
	Top short walls	2	3.60	.35	—	2.52	In to in.
	Bath-W.C. and ver. Long walls (inside)	2	6.10	—	.30	3.66	
	Short walls (inside)	2	2.50	—	.30	1.50	
					C.O.	137.55	

(Ex. 13 Contd.)

Item No.	Particulars of items and details of works	No.	Length m	Breadth m	Height or Depth m	Quantity	Explanatory notes
	Top long wall	1	6.60	.25	B.F.	137.55	
	Bath-W.C. top side	1	2.50	.25	—	1.65	Out to out.
	Verandah top side	1	2.50	.35	—	0.63	In to in.
						0.88	In to in.
	Deduct— Window openings					Total	140.71
	W <sub>1</sub>	3	1.00	—	1.20	3.60	One face only.
	W <sub>2</sub>	1	0.75	—	0.90	0.68	One face only.
	Step	1	1.50	—	0.55	0.83	Including 10 cm. below G.L.
						Total	5.11
					Net	Total	135.60 sq m
							Total of cement pointing outside.
17.	20 mm thick plastering with 1:3 cement and coarse sand finished with neat cement—						
	Tread	2	1.50	0.30	—	0.90	
	Rise	3	1.50	—	0.15	0.68	
	Sides	2	0.60	—	0.15	0.18	
		2	0.30	—	0.15	0.09	
						Total	1.85 sq m
18.	2.5 cm thick c.c. 1:2:4 over and including 7.5 cm lime concrete floor						
	Room	1	6.00	3.60	—	21.60	
	Bath-W.C.	1	2.50	2.50	—	6.25	
	Verandah	1	3.40	2.50	—	8.50	
						Total	36.35 sq m

Item No.	Particulars of items and details of works	No.	Length m	Breadth m	Height or Depth m	Quantity	Explanatory notes
19.	2.5 cm thick c.c. 1:2:4 in sills —						
	Door sill D <sub>1</sub> ...	1	1.20	.30	—	0.36	
	Door sill D <sub>2</sub> ...	1	0.90	.20	—	0.18	
	Sill verandah front	1	3.40	.20	—	0.68	
						Total	1.22 sq m
20.	White washing three coats inside walls		Same as plastering in item	inside (15)	—	127.54	
	Ceiling of room ...	1	6.00	3.60	—	21.60	
	Ceiling of Bath-W.C. ...	1	2.50	2.50	—	6.25	
	Ceiling of verandah	1	3.40	2.50	—	8.50	
						Total	163.89 sq m
21.	Painting door and windows—						
	Door D <sub>1</sub> ...	1 × 2	1.20	—	2.00	4.80	2 time one surface for both sides.
	Door D <sub>2</sub> ...	1 × 2	0.90	—	1.80	3.24	" " " " "
	Windows W <sub>1</sub> ...	3 × 2	1.00	—	1.20	7.20	" " " " "
	Windows W <sub>2</sub> ...	1 × 2	0.75	—	0.90	1.35	" " " " "
	Window bars —						
	W <sub>1</sub> ...	3	0.84	1.04	—	2.62	Excluding chowkhat, one flat area for over all.
	W <sub>2</sub> ...	1	0.59	0.74	—	0.44	" " " " "
						Total	19.65 sq m

(Ex. 13 Contd.)

Item No.	Particulars of items and details of works	No.	Length m	Breadth m	Height or Depth m	Quantity	Explanatory notes
22.	Solignum painting two coats in back of chowkhat—						
	Door D <sub>1</sub> ...	1	5.26	12	—	0.63	
	Door D <sub>2</sub> ...	1	4.56	12	—	0.55	
	Window W <sub>1</sub> ...	3	4.40	10	—	1.32	
	Window W <sub>2</sub> ...	1	3.50	10	—	0.35	
						Total	2.85 sq m

## ABSTRACT OF QUANTITIES (Ex. 5)

1. Earthwork in excavation in foundation	—	19.78 cu m
2. Earthwork in filling in plinth	—	13.35 cu m
3. Lime concrete in foundation	—	6.78 cu m
4. II-class brickwork in foundation and plinth	—	12.26 cu m
5. 2.5 cm Damp proof course	—	8.72 sq m
6. II-class brickwork in superstructure 10 cm upper, 10 cm lower, jambs and sills	—	3.47 cu m
7. II-class brickwork in superstructure in mud mortar	—	27.61 cu m
8. R.C.C. work excluding steel and its bending but including centering and shuttering and binding steel fair finished	—	5.76 cu m
9. Mild steel bars including bending in reinforcement	—	4.52 q
10. 10 cm lime concrete in roof terracing	—	37.10 sq m
11. 4 cm thick insulation layer	—	37.10 sq m
12. Salwood work in chowkhat wrought framed and fixed	—	0.227 cu m
13. 2.5 cm thick salwood work part panelled, part glazed door and window shutters including fittings	—	6.64 sq m
14. Iron work (mild steel) in hold fasts	—	74.93 kg
15. 12 mm thick plastering inside walls	—	127.54 sq m
16. Cement pointing 1:3 outside	—	135.60 sq m
17. 20 cm thick plastering in steps	—	1.85 sq m
18. 2.5 cm thick c.c. 1:2:4 over and including 7.5 cm lime concrete floor	—	36.35 sq m
19. 2.5 cm thick c.c. 1:2:4 in sills	—	1.22 sq m
20. White washing three coats inside walls	—	163.89 sq m
21. Painting doors and windows	—	19.65 sq m
22. Solignum painting two coats in back of chowkhat	—	2.85 sq m

LINE PLAN OF BUILDING

In case of line plan of a building, the dimensions of internal measurements of the rooms are usually given in the plan. In such cases before undertaking the work of estimating, the detailed plan of the building showing the walls, doors, windows, etc., should be drawn and then cross-section of the building with usual foundations and footings should be drawn showing all dimensions. After drawing the plan and section, general specifications may be assumed suitably and then the estimate may be prepared in the usual manner.

If quick work is required without drawing the detailed plan and the cross-section of the building the total centre line length of all walls may be found by assuming the thickness of walls and then the quantities of different items of work may be calculated with this total centre line length by multiplying the respective breadth and or height. Breadth and height may be suitably assumed or a cross-section of wall may be drawn or imagined.

If an approximate estimate is required then the dimensions of the lines in the line plan may be considered as those of the centre line of walls and the total centre line length may be found approximately from these dimensions and then the quantities of different items of works may be calculated approximately with this total centre line length by multiplying by the assumed breadth and height of the respective items.

An illustration of estimating from line plan of a building is given in the following pages :-

**Example 14.** — The line plan of a three-roomed residential building is given in Fig. 3-20. Estimate the quantities of the following items of work approximately :-

1. Lime concrete in foundation.
2. 1st class brickwork in foundation and plinth in lime mortar.
3. Damp proof course at plinth.
4. 1st class brickwork in superstructure in 1 : 6 cement mortar.
5. R.C.C. work in roof slab, lintel and sun shades.
6. Mild steel work in reinforcement in R.C.C. work at one per cent.
7. Lime concrete terracing in roof.
8. 2.5 cm c.c. floor over 7.5 cm lime concrete.
9. 12 mm cement plaster 1 : 6 inside and outside walls.

Suitable cross-section and other data may be assumed

Assuming cross-sections as in Fig. 3-21 and the dimensions as inner dimensions of rooms, the total centre line lengths may be taken as :-

Total centre line length of 30 cm thick walls of main rooms :-

Drawing and dining room —  $(6.00 + .30) \times 2 + (3.20 + .30) \times 2 = 19.60$

Bed room left side —  $(4.00 + .30) \times 2 + (3.00 + .30) \times 2 = 15.20$

Bed room left central remaining walls —  $(3.60 + .30) \times 2 = 7.80$

Total 42.60 m

Total centre line length of 20 cm thick walls of kitchen, store, bath and W.C. —

Kitchen —  $(3.20 + .20) \times 2 + (2.40 + .20) \times 2 = 12.00$

Store room (remaining walls) —  $(2.40 + \frac{.20}{2} + \frac{.30}{2}) \times 2 = 5.30$

Bath room (remaining walls) —  $(1.5 + .20) \times 1 + (2.00 + \frac{.20}{2} + \frac{.30}{2}) \times 2 = 6.20$

W.C. —  $(1.00 + .20) \times 1 + (1.20 + .20) \times 2 = 4.00$

Total 27.50 m

Total centre line length of 20 cm thick verandah walls —

Front verandah —  $(3.60 + \frac{.30}{2} + \frac{.20}{2}) \times 1 + (2.00 + \frac{.20}{2} + \frac{.30}{2}) \times 1 = 6.10$  m

Back verandah —  $(3.60 + .20) \times 1 = 3.80$  m

Total 9.90 m

Total centre line length of parapet 20 cm thick wall over main rooms (perimeter) —

Outer wall right side drawing-cum dining room, back side walls of drawing room and bed rooms, outer left side wall of left bed room and front walls of bed rooms and dining rooms. =  $6.40 + 3.55 + 3.85 + 1.30 + 3.40 + 4.40 + 3.35 + 3.85 + 3.00 + 3.55 = 36.65$  m

Total centre line length of parapet 20 cm thick wall over kitchen, store, bath, W.C. and verandahs —

Outer right side wall of store, outer right side wall of kitchen, back side wall of kitchen, left side wall of kitchen, back verandah, back wall of bath and W.C. left wall of bath, left wall of front verandah and front wall of front verandah — =  $2.50 + 2.60 + 3.40 + 2.60 + 3.30 + 3.30 + 2.25 + 2.25 + 3.30 = 25.50$  m

Total length of plinth wall outer perimeter (starting from right outer wall of drawing-cum-dining room counter clock-wise) —

=  $6.60 + 2.60 + 2.60 + 3.60 + 3.00 + 0.80 + 3.30 + 2.20 + 4.60 + 3.30 + 2.20 + 3.40 + 0.80 + 3.60 = 42.40$  m

THREE ROOMED RESIDENTIAL BUILDING LINE PLAN

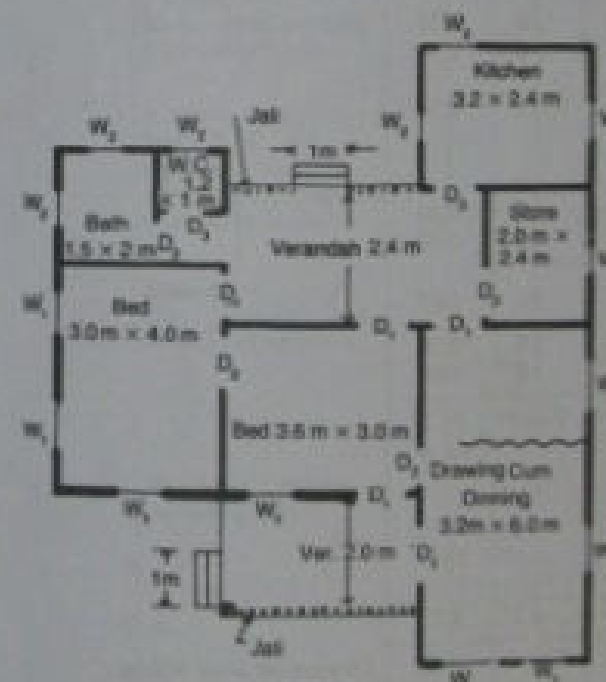

Fig. 3-20

SCHEDULE :-

- D<sub>1</sub> - 100 x 200 cm
- D<sub>2</sub> - 90 x 200 cm
- D<sub>3</sub> - 75 x 200 cm
- W<sub>1</sub> - 90 x 140 cm
- W<sub>2</sub> - 75 x 140 cm

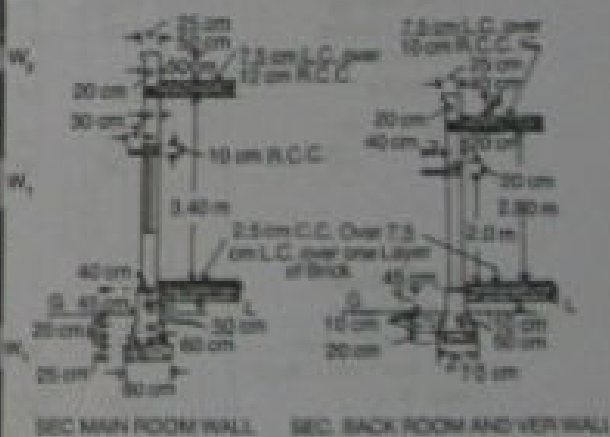

Fig. 3-21

## Line Plan of Building

Item No.	Particulars of items and details of works	No.	Length m	Breadth m	Height or Depth m	Quantity	Explanatory notes
1.	Lime concrete in foundation—						
	Main room walls ...	1	42.60	.80	.25	8.52	L = Total centre line length.
	Kitchen, Store, Bath and W.C. ...	1	27.50	.70	.20	3.85	" " " " "
	Front and back verandah ...	1	9.90	.70	.20	1.39	" " " " "
	Steps ...	2	1.00	.60	.10	0.12	Two treads 30 cm each.
						Total	13.88 cu m
2.	First class brick-work in foundation and plinth in lime mortar—						
	Main room walls—						
	1st footing ...	1	42.60	.60	.20	5.11	
	2nd footing ...	1	42.60	.50	.20	4.26	
	Plinth wall above footing ...	1	42.60	.40	.65	11.08	
	Kitchen, Store, Bath and W.C. —						
	1st footing ...	1	27.50	.50	.10	1.38	
	2nd footing ...	1	27.50	.40	.10	1.10	
	Plinth wall above footing ...	1	27.50	.30	.55	4.54	
	Front and back verandah—						
	1st footing ...	1	9.90	.50	.10	0.49	
	2nd footing ...	1	9.90	.40	.10	0.39	
	Plinth wall above footing ...	1	9.90	.30	.55	1.63	
	Steps — (i)	2	1.00	.60	.15	0.18	
	(ii)	2	1.00	.30	.15	0.09	
						Total	30.25 cu m
3.	2.5 cm thick D.P.C.—						
	Main room walls ...	1	42.60	.40	—	17.04	
	Kitchen, Store, Bath and W.C. ...	1	27.50	.30	—	8.25	
						Total	25.29
							Deduction door sills see next page.

(Ex. 14 Contd.)

Item No.	Particulars of items and details of works	No.	Length m	Breadth m	Height or Depth m	Quantity	Explanatory notes
	Deduct door sills—						
	D <sub>1</sub> ...	5	1.00	.40	—	0.20	
	D <sub>2</sub> ...	2	0.90	.40	—	0.72	
	D <sub>3</sub> ...	2	0.90	.30	—	0.54	
	D <sub>4</sub> ...	2	0.75	.30	—	0.45	
						Total of deduction	1.91
						Net	Total
							23.38
4.	First class brick-work in superstructure in 1 : 6 cement mortar— Main rooms 30 cm walls ...	1	42.60	.30	3.40	43.45	L = Total centre line length
	Kitchen, Store, Bath and W.C. rooms 20 cm wall ...	1	27.50	.20	2.80	15.40	" " " " "
	Front and back verandahs— 20 cm wall above lintel ...	1	9.90	.20	0.60	1.19	" " " " "
	Parapet — Main room parapet over outer walls ...	1	36.65	.20	.575	4.21	L = Total centre line length.
	Kitchen, Store, Bath, W.C. and front and back verandahs, parapet over outer walls ...	1	25.50	.20	.475	2.42	" " " " "
						Total as solid	66.67
	Deduct — Door openings including lintel above—						
	D <sub>1</sub> ...	5	1.00	.30	2.10	3.15	Ht. = 2.00 + .30 = 2.10 m
	D <sub>2</sub> ...	2	0.90	.30	2.10	1.17	" " " " "
	D <sub>3</sub> ...	2	0.90	.20	2.10	0.76	" " " " "
	D <sub>4</sub> ...	2	0.75	.30	2.10	0.63	" " " " "
	Window openings including lintel —						
	W <sub>1</sub> ...	8	0.90	.30	1.50	3.24	Ht. = 1.40 + .30 = 1.50 m
	W <sub>2</sub> ...	2	0.75	.30	1.50	1.58	" " " " "
						Total of deduction	10.49
						Net	Total
							56.18
							cu m

Item No.	Particulars of items and details of works	No.	Length m	Breadth m	Height or Depth m	Quantity	Explanatory notes
5.	R.C.C. work excluding reinforcement and its bending but including centering and shuttering and binding steel						
	Roof slab —						
	Dining-cum-drawing room ...	1	6.60	3.80	.12	3.01	Bearing — Full wall.
	Bed room left ...	1	4.60	3.60	.12	1.99	
	Bed room central ...	1	3.60	3.60	.12	1.56	
	Kitchen ...	1	3.40	2.60	.10	0.88	
	Bath and W.C. ...	1	3.30	2.40	.10	0.79	
	Verandah back including store ...	1	7.60	2.80	.10	2.12	
	Front verandah ...	1	4.00	2.40	.10	0.96	
	Lintels over door —						
	D <sub>1</sub> ...	5	1.20	.30	.10	0.18	Bearing 10 cm.
	D <sub>2</sub> ...	2	1.10	.30	.10	0.07	" "
	D <sub>3</sub> ...	2	1.10	.20	.10	0.04	" "
	D <sub>4</sub> ...	2	0.95	.20	.10	0.04	" "
	Lintels over windows —						
	W <sub>1</sub> ...	8	1.10	.30	.10	0.26	" "
	W <sub>2</sub> ...	7	0.95	.20	.10	0.13	" "
	Front verandah lintel front ...	1	4.00	.20	.20	0.16	Bearing 20 cm.
	Front verandah lintel side ...	1	2.20	.20	.20	0.09	" "
	Back verandah lintel ...	1	4.00	.20	.20	0.16	" "
	Sunshades over windows						
	W <sub>1</sub> ...	8	1.10	.30	.06	0.16	Av. thickness 6 cm.
	W <sub>2</sub> ...	7	0.95	.30	.06	0.12	" "
						C.O.	12.72

(Ex. 14 Contd.)

Item No.	Particulars of items and details of works	No.	Length m	Breadth m	Height or Depth m	Quantity	Explanatory notes
					B.F.	12.72	
	Front verandah sunshade front ...	1	4.40	.40	.06	0.11	Av. thickness 6 cm.
	Front verandah sunshade side ...	1	2.20	.40	.06	0.05	" "
	Back verandah sunshade ...	1	3.60	.40	.06	0.09	" "
					Total	12.97	
6.	Mild steel work including bending in reinforcement at 1% of R.C.C. ...		12.97	× 1 =	.1297	cu m	
			100	× 12.97 × 78.5 =		10.18 q	Wt. of steel 78.5 q per cu m
7.	L.C. terracing in roof 7.5 cm thick —						
	Drawing-cum-dining room ...	1	6.20	3.40	—	21.08	
	Bed room left ...	1	4.20	3.20	—	13.44	
	Bed room central ...	1	4.00	3.20	—	12.80	
	Kitchen ...	1	3.20	2.40	—	7.68	
	Bath and W.C. ...	1	2.90	2.00	—	5.80	
	Back verandah including store ...	1	7.10	2.40	—	17.04	
	Front verandah ...	1	3.60	2.00	—	7.20	
					Total	85.04	
						sq m	
8.	2.5 cm c.c. floor over and including 7.5 cm L.C. —						
	Drawing-cum-dining room ...	1	6.00	3.20	—	19.20	
	Bed room central ...	1	3.60	3.00	—	10.80	
	Bed room left ...	1	4.00	3.00	—	12.00	
	Kitchen ...	1	3.20	2.40	—	7.68	
	Store ...	1	2.40	2.00	—	4.80	
					C.O.	54.48	

Item No.	Particulars of items and details of works	No.	Length m	Breadth m	Height or Depth m	Quantity	Explanatory notes
					B.F.	54.48	
	Bath ...	1	2.00	1.50	—	3.00	
	W.C. ...	1	1.20	1.00	—	1.20	
	Passage to bath ...	1	1.20	0.80	—	0.96	
	Back verandah ...	1	4.90	2.40	—	11.76	
	Front verandah ...	1	3.60	2.00	—	7.20	
	Door sills —						Only 2.5 cm c.c. floor.
	D <sub>1</sub> ...	5	1.00	.30	—	1.50	
	D <sub>2</sub> ...	2	0.90	.30	—	0.54	
	D <sub>3</sub> ...	2	0.90	.20	—	0.36	
	D <sub>4</sub> ...	2	0.75	.20	—	0.30	
	Sills over verandah plinth walls—Front verandah front ...	1	3.60	.20	—	0.72	
	Front verandah side	1	2.00	.20	—	0.40	
	Back verandah ...	1	4.70	.20	—	0.94	
					Total	83.36	
						sq m	
9.	12 mm plastering inside and outside wall with 1 : 6 cement sand mortar—						
	Main room walls, super- structure both sides	1 × 2	42.60	—	3.40	289.68	Total centre length.
	Kitchen, Store, Bath and W.C. both sides	1 × 2	27.50	—	2.80	154.00	" " "
	Back verandah wall above opening inside and outside ...	1	3.60	—	2 × .80	5.76	
	Front verandah wall above opening inside and outside (front and side) ...	1	5.60	—	2 × .80	8.96	L = 3.6 + 2.0 = 5.60 m
	Parapet over main rooms ...	1	36.65	—	1.45	53.14	H <sub>1</sub> = .50 + .25 + .58 + .12 = 1.45 m
					C.O.	511.54	

(Ex. 14 Contd.)

Item No.	Particulars of items and details of works	No.	Length m	Breadth m	Height or Depth m	Quantity	Explanatory notes
					B.F.	511.54	
	Parapet over Kit- chen, Store, Bath and W.C. and Verandahs	1	25.50	—	1.23	31.37	H <sub>1</sub> = .40 + .25 + .48 + .10 = 1.23 m
	Plinth wall out-side including 10 cm below G.L. (outer perimeter)	1	42.30	—	.55	23.27	
			Total	as solid	...	566.18	
	Deduct one surface of door and window openings—						
	D <sub>1</sub>	5	1.00	—	2.00	10.00	
	D <sub>2</sub>	4	0.90	—	2.00	7.20	
	D <sub>3</sub>	2	0.75	—	2.00	3.00	
	W <sub>1</sub>	8	0.90	—	1.40	10.08	
	W <sub>2</sub>	7	0.75	—	1.40	7.35	
			Total of	deductions		37.63	
			Net	Total	—	528.55	
						sq m	

## ABSTRACT OF QUANTITIES (Ex. 14)

1. Lime concrete in foundation	—	13.88 cu m
2. First class brickwork in foundation and plinth in lime mortar	—	30.25 cu m
3. 2.5 cm damp proof course (D.P.C.)	—	23.38 sq m
4. First class brickwork in superstructure in 1 : 6 cement mortar	—	56.18 cu m
5. R.C.C. work excluding steel reinforcement and its bending but including centering and shuttering and binding steel	—	12.87 cu m
6. Mild steel reinforcement including bending in R.C.C. work	—	10.18 q
7. L.C. terracing in roof 7.5 cm thick	—	85.04 sq m
8. 2.5 cm c.c. floor over and including 7.5 cm lime concrete	—	83.36 sq m
9. 12 mm plastering in wall with 1 : 6 cement mortar	—	528.55 sq m



## STOREYED BUILDINGS

The second storeyed, third storeyed, etc., buildings may be estimated in the same method and principle as for one storeyed building, one by one as 1st storey, 2nd storey, 3rd storey, etc. The estimate of upper storey is similar to the estimate of the superstructure of one storeyed building, there being no foundation and plinth walls. The floor of the first floor usually consist of 2.5 cm or 4 cm (1" or 1½") cement concrete over R.C.C. or R.B. or other types of structure. A lime concrete base may also be provided in between the R.C.C. slab and cement concrete floor finish for cushion and better bond, but this will increase the load. The supporting slab or structure and the cement concrete floor are estimated under separate items. Lime concrete terracing is usually provided on the roof of the topmost storey for waterproofing. Estimate of a double storey building has been given at the end of Chapter 5.

Multi-storeyed buildings are constructed either on steel structures or R.C.C. structures or frames with panel walls usually, of one brick 20 cm (9" or 10") thickness. Internal partition walls may be half-brick with hoop iron or wire netting or the equivalent reinforcements at every fourth layer. The height of each storey may be 3 m to 3.50 m (10 ft to 12 ft). For estimating, first the steel structure or the R.C.C. framed building of one storey has been worked out as illustration in Chapter of R.C.C. Work (Chapter 5). Higher storeyed buildings may be estimated on the same principle storey by storey.

Estimate of steel stanchion with beams connections for a double storeyed building has also been given as illustration in Chapter 5.

For construction first the framework, column or stanchions with beams are erected and then the R.C.C. floor slabs are constructed, and then the walling of all storeys are taken up simultaneously. Thus the construction may start simultaneously in all storeys and the whole work may be completed very quickly.

**Thickness of wall.** — In general for one storeyed residential building one brick, 20 cm (9" or 10") thick wall is sufficient. For big size room the walls should be 1½ brick thick. For residential building upto three storeyed without framework the thickness of wall of ground floor may be of two bricks, 40 cm (18 or 20") that of first floor may be of 1½ brick, 30 cm (13½" or 15") and that of the second floor may be one brick, 20 cm (9" or 10"). Walls longer than four-metre length (span) should be thicker than one brick. Walls of small rooms in ground floor and upper floor may be one brick thick. Half brick self-supporting partition wall reinforced with hoop iron or wire netting of 6 mm dia. bar at every fourth layer may be provided where required without any foundation or wall below. The load of the half brick wall or thin wall with proper reinforcement is transferred on the side walls.

Minimum thickness of stone masonry wall may be 30 cm.

CHAPTER 4  
DIFFERENT TYPE ROOFS

Roof may be of R.C.C. slab, R.B. slab, Jack arches, Flat terraced, Madras terraced, Sloping or Pitched roof, etc., R.C.C. and R.B. slab roofs which are commonly used have already been dealt with the building estimates and other types of roofs have been dealt in this chapter.

## JACK ARCH ROOF

Jack arches are segmental arches. The span of the jack arches varies from 90 cm to 1.8 m (3' to 6') with rise of 1/6th to 1/10th of the span and usually consist of a single 10 cm (4½") ring of brickwork laid in lime mortar or cement mortar. The jack arches are spanned and supported on R.S. Joist or R.C.C. beams spaced at regular intervals.

Brickwork in arches may be calculated in cu m, concrete in haunches filling in cu m for average thickness, the roof lime concrete terracing in sq m and the roof surface finishing in sq m, each under separate item.

For calculation the length of the arch is taken as equal to the width of the room plus twice of the thickness of the arch as cover over the walls. The length of arc of the jack arch, i.e. the breadth is taken as the curved length of the intrados. The mean length of arc is same as that of the intrados. For the end bays the mean breadth is slightly greater than the central bays, but for practical purposes this may be taken as same as that of central bays. If the rise of jack arch is ¼ of the span then the length of arc may be taken as 1.07 times the clear span. Clear span may be taken as centre to centre of beams. For haunch filling or spandrel filling the average thickness of concrete is taken as ¼ of the rise of jack arch. The haunch filling is done with weak cement concrete or lime concrete.

According to I.S.I. (IS 1200) jack arch roofing including brickwork in haunch filling and finishing of underside is taken as flat surface as a whole is sq m under one item stating span, thickness of arch, method of laying, jointing and finishing. The lime concrete in roof terracing over the jack arch is taken in sq m stating the thickness (average). And a top surface finishing of roof is taken in sq m under a separate item.

The rods or tie bolts are provided at the end bays with 16 to 20 mm (¾" to ¾") diameter steel bars 1 to 1.5 (3' to 5') apart. The rods are fixed in wall with wall-plates of angle iron, I-joist, etc. embedded inside wall with cement mortar or cement concrete. The rods may also be fixed only with washer plates against the wall.

For construction of brick jack arches continuous centering is not required. A segmental piece of timber about 4 cm (1½") thick in the form of segment to conform to the soffit of arch just to fit in between joints, is placed in position near the wall and brick arch is constructed for one brick length starting from both ends (sides) and proceeding towards the centre and central key brick is placed with stiff mortar and lightly packed by giving light strokes. Bricks are laid with break joints along the length starting alternately with full brick and half brick from one end. The joints at the joints should be filled with cement mortar to protect the joints against rusting and corrosion. When one brick length of the arch is laid, the centering timber is lowered and pushed forward by one brick length and next-length of another brick is laid similarly and the process is continued until the whole length of the arch is completed. The brickwork should be cured for ten days.

The jack arches are usually supported on the lower flange of the joists, but it is better to support the jack arches over the upper flange of the joists so that the joists are not liable to rust and corrosion. Steel joints may also be encased with cement concrete to protect against rusting. Instead of R.S. Joist, R.C.C. beam may also be provided.

## TYPES OF ESTIMATE, SANCTION, PROJECT, ETC.

**Estimate—**

An estimate is the anticipated or probable cost of a work and is usually prepared before the construction is taken up. Before undertaking any work or project it is necessary to know its probable cost which is obtained or derived by estimating. The estimate is prepared by computing or calculating the quantities required and then calculating the cost at suitable rates, to get the expenditure likely to be incurred in the construction of the work or structure.

The primary object of an estimate is to enable one to know beforehand the cost of work. The actual cost is known only after the completion of the work from the account of the completed work. If the estimate is prepared carefully and correctly there will not be much difference in between the estimated cost and the actual cost. For accurate estimating the estimator should be experienced and fully acquainted with the methods of construction.

The estimate may be prepared approximately as a preliminary estimate by various methods without going into details of the different items of work, to know the approximate cost or rough cost.

Accurate estimate is prepared in detail item-wise by *Detailed Estimate*. For 'Detailed Estimate' the work is divided into different items of work, and the quantities under each item are taken out and then an 'Abstract of estimated cost' is prepared at suitable rates. Provision for contingencies, 3% to 5% of the estimated cost, is made in the estimate to cover the miscellaneous petty expenditures which do not come under any item of work. Provision is also made in the estimate for work-charged establishment at 1½% to 2% of the estimated cost.

From the detailed estimate the quantities of various materials and labour required may also be calculated. The estimate also gives an idea of the time required for the completion of the work. The estimate is also required for inviting tenders and to arrange contract and to control the expenditure during the execution.

For complete estimate of a project, besides the estimated cost of the different items of main work, the cost of preliminary works and surveying, cost of land including cost of acquisition, cost of levelling and dressing of ground and the cost of other external services are required to be provided in the estimate. Provision for supervision or departmental charges 5% to 10% of the estimated cost is also made to get the estimated cost of the whole project.

**Data for Estimate —**

To make out an estimate for a work the following data are necessary — (1) Drawing (plan, section, etc.), (2) Specifications, and (3) Rates.

(1) **Drawings**—Plan, sectional elevations, and detailed drawings to scale, fully dimensioned are required. The plan, elevation and sectional elevations are usually drawn to a scale of 1 cm = 1 m (1" = 1') and detailed drawings are prepared to scales of 1 cm = 10 cm to 1 cm = 20 cm (1" = 1' to 1" = 2')

**(2) Specifications—**

(i) **General Specifications or Brief Specifications**—These give the nature, quality and class of work and materials, in general terms, to be used in the various parts of the work. General specifications help to form a general idea of the whole building or structure and are useful in preparing the detailed estimate.

(ii) **Detailed Specifications**—These give the detailed description of the various items of work laying down the quantities and qualities of materials, their proportions, the method of preparation, workmanship and execution of work. Detailed specifications describe every item of work separately, in detail and are helpful for the execution of the different items of work.

(See Chapter 13, Specifications)

**(3) Rates—**

The rates per unit of various items of work, the rates of various materials to be used in the construction, and the wages of different categories of labour, skilled or unskilled as mason, carpenter, maddoor, bhishi, etc., available for preparing estimate. The location of the work and its distance from the source of materials and the cost of transport should be known. These rates may be obtained from P.W.D. Schedule of Rate book or the rates may be worked out by the "Analysis of Rate" method.

**Different Types of Estimate—**

The following are the different types of estimate —

- (1) Preliminary Estimate or Approximate or Abstract Estimate or Rough Cost Estimate.
- (2) Plinth Area Estimate.
- (3) Cube Rate Estimate or Cubical Content Estimate.
- (4) Approximate Quantity Method Estimate.
- (5) Detailed Estimate or Item Rate Estimate.
- (6) Revised Estimate.
- (7) Supplementary Estimate.
- (8) Supplementary and Revised Estimate.
- (9) Annual Repair or Maintenance Estimate (A.R. or A.M. Estimate).

**(i) Preliminary or Approximate Estimate or Abstract Estimate—**

Preliminary or Approximate or Abstract Estimate is required for preliminary studies of various aspects of a work or project, to decide the financial position and policy for administrative sanction by the competent administrative authority. In case of commercial projects as Irrigation Projects, Residential building project and similar projects which earn revenue income, the probable

income may be worked out, and from the preliminary estimate the approximate cost may be known and then it may be seen whether the investment, on the project is justified or not. For non-commercial projects or for projects giving no direct return, their necessity, utility, availability of money, etc., may be considered before final decision is taken. The approximate estimate is prepared from the practical knowledge and cost of the similar works. This estimate is prepared showing separately the approximate cost of all important items of work as cost of land, cost of each building, cost of roads, water supply sanitary works, electrification, etc. The estimate is accompanied by a brief report explaining the necessity and utility of the project and showing how the cost of various items have been arrived at. This is also accompanied with a site plan or layout plan. A percentage of about 5% to 10% is added as contingencies.

The preliminary estimate may be prepared by various ways for different structures and works—

(a) Buildings

- (i) *Per unit basis*—Per student for schools and hostels, per class room for schools, per bed for hospitals, per seat for cinema and theatre halls, per bay for factories, barracks and dormitories, per tenement for residential buildings.

Approximate cost of a hostel building for 100 students @ Rs. 10,000/- per student works out as Rs. 10 lakhs.

Approximate cost of a 100 bed hospital @ Rs. 50,000/- per bed comes to Rs. 50 lakhs.

Approximate cost of a barrack of 10 bays [each bay of 3 m (10') and 6 m (20') wide] @ 10,000/- per bay comes to Rs. 1 lakh.

Approximate cost of a two roomed quarter may be Rs. 60,000/- a three roomed quarter may cost Rs. 1 lakh.

- (ii) *Plinth area basis*  
 (iii) *Cubic content basis*  
 (iv) *Approximate quantity method*

*These are dealt separately in pages 451-452.*

(b) *Roads and Highways*—Per kilometre (per mile) basis depending on the nature of road, width and thickness of metalling, etc. For 10 kilometre of a state highway approximate cost @ Rs. 5,00,000/- per 1 km works out as Rs. 50 lakhs.

(c) *Irrigation Channels*—

- (i) Per kilometre (per mile) basis depending on the capacity of the channel.

- (ii) Area of land commanded i.e., per hectare basis (per acre basis).

The approximate cost of 10 kilometre length of irrigation channel of 3 cu m per sec. capacity @ Rs. 70,000/- per km works out as Rs. 7 lakhs.

For an irrigation project having a commanded area 2000 hectares, approximate cost @ Rs. 1000/- per hectare comes to Rs. 20 lakhs.

(d) *Bridges and Culverts*—Per running metre (running feet) of span depending on the roadway, nature and depth of foundation, type of structure, etc. For small culverts approximate cost may also be per number of culverts of different spans.

Approximate cost of a bridge of 3 spans of 50 metre each span @ Rs. 30,000/- per running metre of span comes to  $3 \times 50 \times 30,000 =$  Rs. 45 lakhs.

Approximate cost of bridges may also be worked out separately for sub-structure and superstructure.

(e) *Sewerage Project and water supply project*—

- (i) On the basis of per head of population served.

- (ii) On the basis of area covered i.e., per hectare basis (per acre basis).

Approximate cost of sewerage project for a population of one lakh @ Rs. 100/- head works out as Rs. 100 lakhs.

Approximate cost of water supply project for a population of 75000 people @ Rs. 90/- per head comes to Rs. 67.5 lakhs.

- (f) *Over head water tank*—On the basis of capacity, per litre (per gallon) of tank depending on the type of structure height of tank etc.

Approximate cost of an overhead R.C.C. water tank of 50,000 litre capacity Rs. 2.00 per litre works out as  $50,000 \times 2.00 =$  Rs. 1 lakh.

(g) *Plinth Area Estimate for Building (P.A. Estimate)*—

This is prepared on the basis of plinth area of building, the rate being deducted from the cost of similar building having similar specification, heights and construction, in the locality. Plinth area estimate is calculated by finding the plinth area of the building and multiplying by the Plinth area rate. The plinth area should be calculated for the covered area by taking external dimension of the building at the floor level. Courtyard and other open area should not be included in the plinth area. Plinth area Estimate is only approximate, and is a preliminary estimate, to know the approximate cost before hand.

If the plan of the building is not ready or available, at the beginning just prepare a proposal, floor area of rooms, etc. may be determined from the requirement and 30 to 40 per cent of the total area thus found may be added for walls, circulation and waste to get the approximate total plinth area which multiplied by the plinth area rate gives the approximate cost of the building.

The approximate cost of a building having plinth area of 100 sq m @ Rs. 900/- per sq m works out as Rs. 90,000/-

For storeyed building, the Plinth Area Estimate is prepared for each storey separately.

(h) *Cube Rate Estimate for Building*—

Cube Rate Estimate is a preliminary estimate or an approximate estimate, and is prepared on the basis of the cubical contents of the building the cube rate being deducted from the cost of the similar building having similar specifications and construction, in the locality.

This is calculated by finding the cubical content of the building, (length × breadth × height) and multiplied it by the cube rate. The length and breadth should be taken as the external dimensions of the buildings at the floor level and the height should be taken from the floor level to top of roof (or the half way of the sloped roof). For storeyed building the height should be taken between the floor level of one storey to top of next higher floor. The foundation and plinth, and the parapet above roof are not taken into account in finding the cubical content. (Based on Indian Standard—IS-1860).

Cube rate estimate is most accurate as compared to the Plinth Area Estimate as the height of the building is also compared.

The approximate cost of a building of cubic content (volume) of 400 cu m @ Rs. 180/- per cu m comes to Rs. 72,000/-.

*Note—The technical data and information given in Chapter 15 will be helpful for Preliminary estimates for various original works and maintenance works.—A few illustration of Preliminary estimate are given at the end of this Chapter.*

#### (4) Approximate Quantity Method Estimate—

In this method approximate total length of walls is found in running metre and this total length multiplied by the rate per running metre of wall gives a fairly accurate cost. For this method the structure may be divided into two parts viz. (i) foundation including plinth and (ii) superstructure. The running metre cost for foundation and superstructure should be calculated first and this running metre rate should be multiplied by the total length of walls.

To find the running metre rate for foundation, the approximate quantities of items such as excavation, foundation, brick work upto plinth, and damp proof course are calculated per running metre and by multiplying by the rates of these items the price or rate per running metre is determined.

Similarly for superstructure the price or rate per running metre is determined from the approximate quantities of brickwork, wood works, roof, floor finishing, etc.

For this method the plan or line plan of the structure should be available.

#### (5) Detailed Estimate or Item Rate Estimate—

Detailed estimate is an accurate estimate and consists of working out the quantities of each item of works, and working the cost. The dimensions, length, breadth and height of each item are taken out correctly from drawing and quantities of each item are calculated, and abstracting and billing are done.

The detailed estimate is prepared in two stages :—

##### (i) Details of Measurement and Calculation of Quantities—

The details of measurements of each item of work are taken out correctly from plan and drawings and quantities under each item are computed or calculated in a tabular form named as *Details of Measurement Form* (See page 5).

#### (ii) Abstract of Estimated Cost—

The cost of each item of work is calculated in a tabular form from the quantities already computed and total cost is worked out in *Abstract of Estimate Form* (See page 6). The rates of different items of work are taken as per schedule of rates or current workable rates or analysed rates for finished items of work. A percentage usually 3% of the estimated cost is added to allow for contingencies for miscellaneous petty items which do not come under any classified head of items of work and a percentage of about 2% is provided for workcharged establishment. The Grand total thus obtained gives the estimated cost of work.

The detailed estimate is usually prepared work-wise, under each sub-work as main building, servant quarters, garage, boundary walls etc.

The detailed estimate is accompanied with :—

- (1) Report.
- (2) General specifications.
- (3) Detailed specifications.
- (4) Drawings—Plan, elevation, Sectional elevations, Detailed drawings, Site plan or Layout plan or Index plan etc.
- (5) Calculation and designs—Designs of foundation, beam, slab, lintel, design of channel in case of irrigation channel, design of thickness of metal crust in case of road etc.
- (6) Analysis of rates, if rates are not as per schedule of rates or for the non-scheduled items.

Detailed Estimate is prepared for technical sanction of the competent authority, for arranging contract and for the execution of work.

*If in the 'Abstracts of Estimate' form the columns of rates and amounts are left blank to be filled by contractor it is then known as bill of Quantity.*

#### (6) Revised Estimate—

Revised Estimate is a detailed estimate and is required to be prepared under any one of the following circumstances :—

- (i) When the original sanctioned estimate is exceeded or likely to exceed by more than 5%.
- (ii) When the expenditure on a work exceeds or likely to exceed the amount of administrative sanction by more than 10%.
- (iii) When there are material deviation from the original proposal, even though the cost may be met from the sanctioned amount.

The revised estimate should be accompanied by a comparative statement showing the variations of each item of works, its quantity, rate and cost under original and revised, side by side, the excess or saving and reason for variation.

**(7) Supplementary Estimate—**

Supplementary Estimate is a detailed estimate and is prepared when additional works are required to supplement the original works, or when further development is required during the progress of work. This is a fresh detailed estimate of the additional works in addition to the original estimate.

The Abstract should show the amount of the original estimate and the total amount including the Supplementary amount for which sanction is required.

**(8) Supplementary and Revised Estimate—**

When a work is partially abandoned and the estimated cost of the remaining work is less than 95 per cent of the original work, that is less than 95 per cent of the original sanctioned estimate, or when there are material deviations and changes in the design which may cause substantial saving in the estimate, then the amount of the original estimate is revised by the competent authority. A supplementary and Revised Estimate is then prepared and fresh Technical sanction of the competent authority is obtained.

If at any time either before or during the execution of original work, it is found that the original estimate is excessive, then Divisional officer may sanction a revised estimate of reduced amount. While giving such sanction the Accountant General and other higher authorities are informed.

**(9) Annual Repair or Maintenance Estimate (A.R. or A.M. Estimate)—**

Annual Repair or Annual Maintenance Estimate is a detailed estimate and is prepared to maintain the structure or work in proper order and safe condition. For building, this includes whitewashing, colour washing, painting, minor repairs etc. For road works the A.R. estimate provides for patch repairing, renewals, repairs of bridges and culverts, etc.

Further, there may be special repair estimate, Monsoon damage repair estimate, etc. (For different type of repair estimate See Chapter 17).

**Contingencies—**

The term 'Contingencies' indicates incidental expenses of miscellaneous character which cannot be classified under any distinct item sub-head, yet pertain to the work as a whole.

In an estimate a certain amount in the form of contingencies of 3 per cent to 5 per cent of estimated cost, is provided to allow for the expenses for miscellaneous petty items which do not fall under any sub-head of items of work. Miscellaneous incidental expenses which cannot be classified under any sub-head or item, are met from the amount provided under contingencies.

If there is any saving against the amount provided under contingencies, this amount may be utilised with the sanction of the competent authority, to meet the expenses of extra items of work, if any unforeseen, expenditure, expenses to minor changes in design, etc.

**Work-charged Establishment—**

Work-charged Establishment is the establishment which is charged to works directly. During the construction of a building or a project, a certain number of work-supervisors, chaukidars,

mates munshees, etc., are required to be employed, and their salaries are paid from the amount of work-charged establishment provided in the estimate. For work-charged establishment a percentage of 1½% to 2% of the estimated cost is included in the estimate. The work-charged employees are temporary staff and their appointment shall have to be sanctioned by the competent authority for a specified period. Their services are terminated at the expiry of the sanctioned period, if their services are required fresh sanction shall have to be taken. Their services can, however, be terminated at any time but usually one month's notice is given. (See also Chapter 17—P.W.D. Account and Procedure for Works).

**Tools and Plants (T. and P.)**

For big work or project a percentage of 1% to 1½% of the estimated cost is provided in the estimate for the purchase of Tools and Plants which will be required for the execution of the work. Normally the contractor has to arrange and use his own tools and plants. (For further details, See Chapter 17—P.W.D. Account and Procedure for Works).

**Centage Charges or Departmental charges—**

When the engineering department takes up the work of other department a percentage amount of 10% to 15% of the estimated cost is charged to meet the expenses of establishment, designing, planning, supervision, etc., and this percentage charge is known as Centage Charge. The Centage Charge is also made on contributory and deposit works of local bodies, private persons and others. The Centage Charge is provided in the estimate of the work of Central Government is undertaken for execution. These charges are also known as Supervision Charges for works.

**Report—**

Estimate is usually accompanied with a report which gives all information in brief, of the whole work or project. Report should be such as to give a clear picture or idea of the whole project or work. Report should consist of the following main points :—

- (i) Brief history, with reference to the proposal.
- (ii) Object, necessity, utility and feasibility of the project with reasons.
- (iii) Selection of site or selection of alignment.
- (iv) Surveying.
- (v) Accommodation provided or brief description of the works provided in the estimate.
- (vi) Nature of soil, and topography of the land, orientation, etc.
- (vii) General specifications and basis of design calculations.
- (viii) Arrangements for water supply, sanitary works and electrical installations.
- (ix) Roads and drains.
- (x) Miscellaneous items as labour amenities, temporary accommodation for staff, etc. for big project.
- (xi) Manner of execution.
- (xii) Total cost and how to be financed.
- (xiii) Return or revenue income if any.

- (xiv) Rent statement if any.  
(xv) Time of execution.

A few typical reports have been given in the Chapter 15—'Report, Technical and Design Data'.

#### Site Plan—

For all building plans site plans are prepared to a small scale of 1 cm=5 m to 1 cm=10 m (1"=40' to 1"=80') showing the orientation of the building, boundaries of land, position of roads, drains, sewer line, water pipelines, and adjoining plots of lands with their ownership. The North direction line is also shown on one corner of the site plan to show the geographical orientation of the building. In site plan, the building and other details are drawn in line diagram. From the site plan, location of the work with respect to the surrounding is known.

#### Layout Plan—

For a project consisting of a number of buildings and structures a Layout plan of the whole area is prepared to a small scale of 1 cm=10 m to 1 cm=20 m (1"=80' to 1"=160') with all proposed buildings, structures, etc. showing their sizes, positions, locations and orientations. Besides the buildings and structures the roads, lanes, drains, pipe lines, electric lines, parks, etc. are also shown in the layout plan with their proper notations. The boundary, the main approach roads and adjoining areas with their ownership, name, nature etc., are also indicated in the layout plan. In Layout plan the details are shown in line diagram. The North direction line is also shown in one corner of the layout plan to indicate the geographical orientation of the buildings. The layout plan gives a general idea of the project at a glance. (For layout plan see Chapter 18—'Colony Planning and Chapter 19—'Village Housing').

#### Index Plan—

For Road project, Irrigation project, Water supply project, Sanitary work project, Major building project etc., an index plan to a scale 1 cm=0.5 km (1"=1 mile) is prepared showing alignment with position of culverts, outlets and other main works or main outlines of the whole work so that at a glance an idea of the project may be formed. For big project the Index plan is drawn with a much small scale and is known as key plan.

#### Electrification, Sanitary and Water Supply Works.—

In building work for internal Electrification, Sanitary and Water Supply works a percentage of about 20% of the estimated cost of building is provided. The provision are usually made as given below—

For Sanitary and Water Supply Works	... 8% of the estimated cost of building works.
For Electrification	... 8% of the estimated cost of building works.
For Electric Fans	... 4% of the estimated cost of building works.

Internal Electrification includes electric wiring for light, fan and plug points, pendants, brackets, shades, holders, bulbs, switch boards, cut-out etc. Excluding fans 8% of the estimated cost may be sufficient for electrification.

Internal Water Supply works include water pipe line, bib-cocks, stop-cocks, fittings, overhead tanks etc., and internal Sanitary works include sewer pipe line, water closets, cisterns, fittings, intercepting traps, etc. (See the Estimate of Sanitary and Water Supply Works of a Building in chapter 10).

Detailed estimate are usually prepared subsequently. Detailed estimate of Electrification and Sanitary and Water Supply Works may also be prepared initially while preparing the estimate of building work.

The cost of electrification, may vary from 3% to 8% of building cost and the cost of Sanitary and Water Supply Works may vary from 5% to 8% of building cost. In unsewered area an additional amount of about 3% to 4% of the building structure may be required for the provision of Septic tank, etc.

#### Sub-head of Items of Work—

The term sub head is used to describe the sub-divisions into which the total cost of a work is divided for financial control and statistical convenience.

The whole work is divided into different classes of items, and items of similar nature are grouped under sub-heads of work are as follows—

- (i) Earthwork, (ii) Concrete, (iii) Brick-work, (iv) Stone work, (v) Wood work, (vi) Steel-work, (vii) Roofing, (viii) Flooring, (ix) Plastering, and pointing, (x) Painting and Distemping, (xi) White washing and colour washing, (xii) Miscellaneous items.

Under each sub-head there are different items of work. Under the sub-head 'Earthwork' the cost of all items of earthwork as earthwork in excavation, earthwork in filling, dressing of earthwork etc., are taken. Similarly, under the sub-head 'Concrete' the cost of all items of concrete as lime concrete, cement concrete, reinforced cement concrete, etc., are taken, and so on for other sub-heads. R.C.C. work may be taken under a separate sub-head of work. The rates in the P.W.D. 'Schedule of Rates' are grouped sub-head wise (See the Schedule of Rates given at the end of the book).

The detailed estimate is prepared sub-head wise and items are grouped under different sub-heads, and during the execution accounts are kept sub-head wise to keep a check on the expenditure. Example No. 9 (page 252) has been estimated sub-head wise under ten sub-heads. (See page 252-261).

#### Sub-work—

A large work or project may consist of several buildings or small works and each of these work is known as sub-work. Detailed estimate of each sub-work is prepared separately and accounts of expenditure are kept sub-work wise.

A hospital project may consist of:  
(i) Main hospital building, (ii) Out patient ward, (iii) Emergency ward, (iv) Resident doctor's quarters, (v) Nurses quarters, (vi) Kitchen blocks, (vii) Roads, etc. and each will be a sub-work.

In the case of irrigation project, the head works, Main canal, each Branch canal, each group of Distributaries, Draining works, Special Tools and Plants etc. all form separate sub-works.

**Summary or Estimated Cost or General Abstract of Cost—**

When the whole work or project consists of number of works or sub-works detailed estimate and abstract of estimated cost are prepared for each sub-work separately, and at the end a Summary of Estimated Cost or General Abstract of Cost is prepared for the whole work or project. The Summary of Estimated Cost includes the cost of each sub-work and gives the total cost of the whole work or project.

**Complete Set of Estimate—**

Detailed estimate is prepared in standard forms and the complete set of estimate consists of —

(i) Title page giving name of the Engineering Department, Division, District or Sub-Division, Estimate No., Name of work, and Amount of estimate, (ii) Index of contents and plan and drawings, (iii) Report, (iv) Design calculations, (v) General specifications, (vi) Detailed Specifications (vii) Analysis of Rates if required, (viii) Details of Measurements and Calculation of Quantities, (ix) Abstract of Estimated Cost, (x) General abstract of Cost, (xi) Drawings—plan, elevations, detailed drawing, site plan, index plan etc.

At the end of the Abstract of Estimated Cost or Summary of Estimated Cost there should be signature of the Assistant Engineer, Executive Engineer and Superintending Engineer, and on the back page head of account should be given.

**Schedule of rates—**

Schedule of rates is a list of rates of various items of works. To facilitate the preparation of estimates, and also to serve as a guide in setting rates in connection with contract agreements, a schedule of rates for all items of work is maintained in the Engineering Department in the form of a printed books known as "Schedule of Rate Books."

Rate per unit of various items of work and materials, rates of wages of labour and rates of transport are given in the 'Schedule of Rates'. P.W.D. maintain printed schedule of rate book for various items of the work and estimate is prepared with these rates. The rates are workable rates for the completion of the items including materials, transport, labour, profit, etc. The Schedule of Rate is prepared on the basis of analysis of rates. Usually, transport of materials upto distance of 8 km (5 miles) is included in the rates. As the rates vary slightly from year to year, the rates are increased or decreased by a percentage on the 'Schedule of Rates'. If the workable rates differ much from the 'Schedule of Rates', then the rates are revised and a new 'Schedule of Rates' is prepared. (Schedule of rates are given at the end of the book).

P.W.D. also maintain 'Road Metal Rate Book' giving the rates of different types of road metal of different roads kilometer wise (mile wise). Estimate for road works are usually prepared on the basis of rates provided in the 'Road Metal Rate Book'.

**Building Cost Index—**Building cost index indicate the increase or decrease of the cost above the cost at the certain base year, and is expressed by a percentage rise or fall. Taking 1960 as the base year, the present, (during 1989) Building Cost India, may be taken as 30% above the cost during

1970. The cost index depends mainly on the cost of materials, labour transport, etc. and may be above or below according to their costs. The Public Work Department indicates the present cost at a percentage above or below the printed Schedule of rates maintained by the Department.

**Administrative Approval or Sanction—**

For any work or project required by a department, an approval or sanction of the competent authority of the department, with respect to the cost and work is necessary at the first instance. The approval authorises the engineering department to take up the work. Administrative approval denotes the formal acceptance by the department concerned of the proposal, and after the administrative approval is given the engineering department (P.W.D.) take up the work and prepares detailed designs, plans and estimates and then executes the work. The engineering department prepares approximate estimate and preliminary plans and submits to the department concerned for administrative approval. (See also Chapter 17 P.W.D. Account and procedure for works).

**Expenditure Sanction—**

Expenditure sanction means the concurrence of the Government of the expenditure proposed and represents allotment of the money to meet the expenditure. No expenditure can be incurred before Expenditure Sanction is given. Expenditure sanction means allotment of fund or money for a specific work and is usually, accorded by the Finance Department.

**Technical Sanction—**

Technical sanction means the sanction of the detailed estimate, design calculations, quantities of works, rates and cost of the work by the competent authority of the engineering department. After the technical sanction of the estimate is given, then only the work is taken up for construction. In case of original work the counter signature of the local head of the department should be obtained in the plan and estimate before technical sanction is accorded by the engineering department. The power for Technical Sanction differs from state to state.

**Power for Technical Sanction in U.P.—** Technical Sanction can be given by—

- |                                  |   |  |
|----------------------------------|---|--|
| (i) The Chief Engineer           | — | Full Powers.   |
| (ii) The Superintending Engineer | — | Up to Rs. 15 lakhs.  |
| (iii) The Executive Engineer     | — | Up to Rs. 5 lakhs if the estimate is on a standard design. |

**Bill of Quantities.—**It is a statement of the various items of work giving the description, quantities and unit of rates. It is prepared in a tabular form similar to the 'Abstract of Estimated Cost' of the detailed estimate, but the rate and amount columns are left blank (unfilled). When filled, that is, the rates and the amounts are filled up and totalled, this gives the estimated cost. It is primarily meant for inviting tender, and supplied to the contractor to fill up the rates and amounts columns. On receipt of the tenders the rates and amounts are compared and decision about executing the work is finalised.

Bill of Quantities (Typical Sheet)

Item No.	Particulars of items	Qty.	Rate Rs. P.	Unit Per	Amount	
					Rs.	P.
1.	Earthwork in excavation	32.51		per % cu m		
2.	Earthwork in filling	27.48		per % cu m		
3.	Lime concrete in foundation	11.33		per cu m		
4.	First class brickwork in lime mortar in foundation and plinth	25.14		per cu m		
5.	Damp proof course 2.5 cm C.C. 1: 1½: 3	11.02		per sq m		
6.	First class brickwork in 1:6 cement mortar in superstructure	31.76		per cu m		
7.	So on	—		—		

Note—For different types of works, tenders, contract, security money, measurement, payment, preparation of project, stock account etc. (See Chapter 17 P.W.D. Account and procedure for Works)

**Day Work.**—The term 'day work' is used to denote a procedure of costing or valuing an item of work on the basis of actual labourers and materials required. Certain items of work which cannot be measured as — a design in the plaster work, front architectural finish of a building, work under water, etc. are valued and paid by 'day work'. In such cases the schedule of rates of materials and different classes of labourers likely to be engaged in the work should be included in the tender and in the contract agreement. For the purpose of 'day work' payment, the contractor is to maintain day work sheets where the details of various materials actually used and the details of hours of working of each type of labourers should be recorded. The day work sheet should be frequently checked and verified by the engineer. The 'Day work' prices usually include material, labour, transport, contractor's profit and overhead charges, tools and plants etc. 'Day Work' method of payment is usually confined to small items of works and may be on hourly basis so that payment may be made for the actual period for which the labourers worked.

**Prime Cost.**—Prime cost is the actual cost of articles at shop and refers to the supply of articles only and not to the carrying out of work. It is not always possible at the time of preparing estimate and even when entering contract, to specify exactly the types of articles required. For example water supply fittings, sanitary fittings, door and window fittings, etc. are to be decided during the

time of actual fitting according to the choice of the owner or Engineer-in-charge. For the execution of such items a reasonable amount is kept in the estimate as Prime cost, and the same is also provided in bill of quantities of contract. The supply of the articles will be made by the contractor on receiving the instructions and approval of the Engineer-in-charge regarding quality and price. The price to be paid to the contractor for Prime cost articles will be actual price paid by him to the merchants, ignoring any cash discount which he might have received. Contractor is not allowed any profit on the 'Prime cost' articles but he may be allowed actual cost for carriage, if specified. While tendering, the contractor should not alter the amount of Prime cost, if he does, such alteration will be ignored. The Prime cost articles may also be obtained or purchased directly or through some other agency. The fixing of the Prime cost articles are usually done by the original contractor for which separate rates are provided. The work of fixing is provided in the contract agreement.

**Provisional Sum.**—Provisional sum is the amount provided in the estimate and bill of quantities for some specialized work to be done by a specialist firm, whose details are not known at the time of preparing estimate. The work like installation of refrigerating machine, installation of lift, air conditioning, etc., for which full information and details may not be known at the time of preparing estimate and entering into contract and are required to be installed by a specialist firm, a reasonable amount is provided in the estimate and in the bill of quantities of contract as Provisional sum. The amount paid to the contractor will not necessarily be the exact amount of Provisional sum but will depend upon the arrangement made at the time of execution on the basis of full information then available. The contractor should not alter the amount of 'Provisional sum' amount while tendering if he does, such alteration will not be valid and the original amount will stand. The Provisional sum item may be got installed or executed directly by some specialist firm if so desired by the Engineer-in-charge or the owner.

The items of work under Provisional sum or Prime cost known as Provisional sum item and Prime cost item respectively. In both cases the amount is provided as lump sum amount.

Work which by nature cannot be accurately taken off, or which requires site measurement shall be described as Provisional.

Where the classification and or quantity of excavation cannot accurately be ascertained before-hand the item and quantity shall be shown as Provisional

Builder's hardware which is not ordinary stock pattern shall be taken as Prime cost item. The service pipe connections with water main, if the length of pipe and the charges of the local authorities are not known, shall be provided as Provisional

The electric service connection for electrification of a building shall be provided as Provisional as the charges of the Electricity department are not known.



Example of *Provisional sum* and *Prime cost* items are given below :—

*Provisional item*.—One refrigerating machine including freight and carriage to site and fitting in position with all electrical connections, holes in the wall, etc. ... Provisional sum Rs. 4000.00

*Prime cost item*.—Door and window fittings as approved by Engineer-in-charge including carriage — — — Prime cost Rs. 600.00

*Fixing of door and window fittings shall be included in the rates of door and window leaves or shutters per sq m basis.*

*Prime cost item*.—Mosaic tiles for dado as approved by the Engineer-in-charge (40 sq m) including carriage to site... Prime cost Rs. 1000.000

*For laying and fixing tiles in wall with 1 : 4 cement mortar excluding cost of tiles, separate items shall be provided with rate on the sq m basis.*

**Provisional Quantities.**—When the quantities of a particular item are not certain *Provisional quantities* are provided separately for such items. For this purpose the quantities are calculated from measurements of the drawings with certain assumption of the probable increase, and are kept separately in the bill of quantities and marked as *Provisional*. For a building if the nature of soil is uncertain, and if it is thought that extra depth of foundation, will be required then normal quantities of earthwork, foundation concrete, and brickwork will be calculated from the dimensions as given in the drawing and the additional quantities of earthwork, foundation concrete and brickwork due to the probable extra depth are worked out separately and these additional quantities are marked as *Provisional quantities*. In the tender and in the bill of quantities of contract, the provisional quantities will be shown separately and the contractor shall have to quote rates for the *Provisional quantities* but the payment of these quantities will be made on the completion of these items of work as actually done. It may be noted that during execution extra depth may not be required and the amount against provisional quantities may not be paid.

When there is a possibility of certain concrete piles required to be lengthened in position, *Provisional quantities* for the work shall be provided separately for the additional quantities.

**Quantity Survey.**—Quantity survey is a list or schedule of quantities of all the possible items of work required for construction of any building or structure. These quantities are worked from the plan and drawings of the structure. Thus the *quantity survey* indicates the quantities of work to be done under each item which when priced per unit gives the amount of cost. In short *quantity survey* means estimating of the quantities of different items of works.

**Plinth Area.**—*Plinth area* is the built up covered area of a building measured at floor level of any storey. *Plinth area* is calculated by taking the external dimensions of the building at the floor level excluding plinth offsets if any. Court-yard, open areas, balconies and cantilever projections are not included in the *Plinth area*. Supported porches (other than cantilevered) are included in the *Plinth area*.

The following shall be included in the *Plinth area*.—(i) All floors, area of walls at the floor level excluding plinth offsets, if any. (ii) Internal shafts for sanitary installations provided these do not exceed 2 sq m in area aircondition ducts, lifts etc. (iii) The area of *barsati* and the area of *mumty* at terrace level. (iv) Area of porches other than cantilevered.

The following shall not be included in the *Plinth area*.—(i) Area of loft. (ii) Internal sanitary shafts provided these are more than 2 sq m in area. (iii) Unenclosed balconies (iv) Towers, turrets, domes etc. projecting above the terrace level, not forming a storey at the terrace level. (v) Architectural bands, cornices etc. (vi) *Samhadis*, Vertical sun breakers or box louvers projecting out.

**Floor Area.**—*Floor area* of a building is the total area of floor in between walls and consists of floor of all rooms verandahs passages corridors staircase room, entrance halls, kitchen, stores, bath and latrine (W. Cs.) etc. Sills of doors and openings are not included in the *Floor area*. Area occupied by walls, pillars, pilaster, and other intermediate supports are not included in the *Floor area*. In short, *Floor area* is equal to *Plinth area* minus area occupied by walls.

For deduction of wall area from *plinth area* to obtain *Floor area* the area shall include— (i) Door and other openings in the wall. (ii) Intermediate pillars and supports. (iii) Pilasters along walls exceeding 300 sq cm in area (iv) Flues which are within walls. But the following shall be excluded from the walls area (i) Pilaster along walls not exceeding 300 sq m in area. (ii) Fire place projecting beyond the face of wall in living rooms. (iii) Chulla platforms projecting beyond the face of wall in kitchens.

The floor of each storey and different types of floor should be measured and taken separately. The floor area of basement, mezzanines, *barsatis*, *mumties*, porches, etc. should be measured separately.

**Circulation Area.**—*Circulation Area* is the floor area of verandahs, passages, corridors, balconies, entrance hall, porches, stair cases, etc., which are used for movements of persons using the building. The *circulation Area* of any floor shall comprise of the following :—

(a) Verandahs and balconies, (b) Passages and corridors, (c) Entrance halls, (d) Stair case and *mumties*, (e) Shafts for lift.

The circulation area may be divided into two parts : (1) Horizontal circulation area and (2) Vertical circulation area.

**Horizontal Circulation Area.**—*Horizontal area* of a building is the area of verandahs, passages, corridors, balconies, porches, etc. which are required for the horizontal movement of the users of the building. This may be 10% to 15% of the *plinth area* of the building.

**Vertical Circulation Area.**—*Vertical circulation area* of a building is the area or space occupied by stair cases, lifts and the entrance halls adjacent to them which are required for vertical movement of the users of the building. This may be 4% to 5% of the *plinth area* of the buildings.

**Carpet Area** — Carpet Area of building is the useful area or liveable area or lettable area. This is the total floor area minus the Circulation area, verandahs, corridors, passages, staircase, lifts, entrance hall, etc. and minus other non-useable areas as sanitary accommodations (Bath and W.C.), air conditioning room etc. For office building Carpet area is the lettable area or useable area and for residential building Carpet area is the liveable area and should exclude the kitchen, pantry, stores and similar other room which are not used for living purposes.

The carpet area of a building for any storey shall be the floor area excluding the following :

(a) Sanitary accommodation, (b) Verandahs, (c) Corridors and passages, (d) Kitchens and pantries, (e) Stores in domestic buildings, (f) Entrance hall and porches, (g) Stair cases and masonry, (h) Shafts for lifts, (i) Baysies, (j) Garages, (k) Canteens, (l) Air conditioning ducts and air conditioning plant room.

The Carpet area of an office building may be 60% to 75% of plinth area of the building with a target of 75%. The planners should aim to achieve a target to 75% of the plinth area. The carpet area of residential building may be 50% to 65% of the plinth area of building with a target of 65%.

For a framed multistoreyed building the area occupied by wall may be 5% to 10% of the plinth area (a standard 3% for external walls and 2% for internal walls). For ordinary building without frame, the area occupied by walls may be 10% to 15% of the plinth area.

*Note* — The plinth area, Circulation area, Floor area, Carpet area, etc., should be measured or taken separately for each storey or floor.

(The description of the different area dealt above are based on the Indian Standard IS : 3881).

**External services** — In a project besides the building structure, certain outside works are required which come under *External services*. External service or work include the following :

(i) Digging filling, levelling and dressing of road, (ii) Road including approach road if any, (iii) External sewerage, sewage, disposal of works, (iv) External water supply works, water pipe line, tube well and storage tank, pump set, if any, (v) External electrical service line with poles, if any, (vi) Storm water drains, fencing or compound wall, gate, etc., (vii) Arboriculture, plantation of trees. The cost of external service works should be included in the complete estimate. The cost of external service works should be included in the complete estimate. The cost of external service works may vary from 10% to 20% depending on the nature and size of the project.

**Capital Cost** — Capital cost of work is the total cost of construction including all expenditure incurred from the beginning upto the end of the completion of the work. Besides the cost of building as structure the cost of external services and all other works involved are included. The Capital Cost also includes the cost of preliminary works, miscellaneous items,

supervision charges etc. For a project the *capital cost* is the total cost of the whole project including, all buildings, structures, external services, etc. cost of the land may also be included in the capital cost. (See also Chapter 16—Valuation)

**Project** — Project means a full scheme consisting of detailed technical report, history design data and calculations, drawings, specifications, rates, project estimates etc. It is the detailed requirements of a proposal or scheme. The project gives full details of all works involved for both structural and financial requirements.

It requires preliminary investigation and surveying and selection of site or alignment to start with and then the detailed surveying before taking up preparation of details of the project. Detailed estimate of all works are prepared separately and a general abstract of cost is prepared showing the cost of the whole project. Drawings of all works — Plans, elevations, sectional elevations and necessary detailed drawings — and layout plan or index plan of the whole project are prepared. General specifications of all works are given separately and detailed specifications of each item of works are also given for all works.

Besides the building, structures etc. provisions are also made for external services as outer water supply and sanitary works, storm water drains, roads, electric service lines, etc. Cost of land and levelling and dressing of land are also included. The cost of preliminary investigation work is also included in the project estimate.

For a big project in the interior, as for a dam project, the temporary accommodations for staff and workmen are required and included in the project estimate. Cost of the approach road with bridges and culverts have also included in the project estimate.

Provisions for contingencies, workcharged establishment and tools and plants are also made in the estimate. Departmental charges 2% to 10% of the whole project estimate is added to meet the expenditure for the preparation and execution of the project.

Statement of financial return, cost statement, etc., are also prepared to justify the project.

For Hospital Project the following accommodation may be required —

Administrative block, General ward, Special ward, Emergency ward, Out patient ward, Operation theatre, Mortuary, General store, Kitchen block, Doctor's residence, Nurses quarters, Clerk's quarters, Peon's quarters, Garages etc.

Provisions for land; Levelling and dressing of Land, Roads, Water supply works — tube-well, pump, overhead tank, pipe lines Sanitary works — septic tank, sewer line, Electric service line, Compound wall or fencing, Arboriculture (Plantation of trees), etc. are also required to be made.

**Complete Estimate of a Project** —

The complete estimate of a project or building structure should include all items of expenditure from the beginning up to the end. The complete estimate include the following —

(i) The cost of preliminary works as surveying preliminary observations and investigations and other preliminary works, (ii) The cost of land including its acquisition and legal expenses, (iii) Cost of improvement of land by levelling, digging and filling if required, (iv) Cost of planning, designing, preparation of estimate etc. (v) Cost of building of structure, including internal electrification, sanitary and water supply works, (vi) Cost for supervision charges during execution of works, (vii) Cost of temporary accommodation or staff labour and other amenities (for big project only), (viii) Cost of water supply and electric connection during construction, (ix) Cost of external services as roads, electric service lines, storm water drains, external water supply and sanitary works etc. (x) Cost of maintenance and repair works and other running expenditures during the constructions (if the construction run for a number of years), (xi) For building designed and supervised during construction by an Architect, the fees of Architect should also be included in the estimate.

For different stages of preparation of Project and the Execution of Major work, see Chapter 17 — 'P.W.D. Accounts and Procedure for Works'.

#### EXAMPLES OF PRELIMINARY ESTIMATE

**Example 1** — Prepare a preliminary estimate of a building project with a total plinth area of all buildings of 1500 sq m. Given that —

- Plinth area rate — Rs. 950.00 per sq m.
- Extra for special Architectural treatment — 1½% of the building cost.
- Extra for Water supply and Sanitary Installations — 5% of the building cost.
- Extra for internal installations 14% of the building cost.
- Extra for services — 6% of the building cost.
- Contingencies — 3%
- Supervision charges — 8%.

<i>Q. 1964 Suppl. Tech. Board U.P. (Modified)</i>	
Building cost — 1500 sq m @ Rs. 950.00 per sq m = 1500 × 950	= Rs. 1425000.00
Special Architectural treatment — 1½% of building cost 1425000 × 1.5/100	Rs. 21375.00
Water Supply and Sanitary installation — 5% of building cost	= 1425000 × 5/100 = Rs. 71250.00
Internal Electrical Installations — 14% of building cost = 1425000 × 14/100	= Rs. 199500.00
Other services — 6% of building cost	= 1425000 × 6/100 = Rs. 85500.00
Total	Rs. 1802625.00
Contingencies — 3% over all	= 1802625.00 × 3/100 = Rs. 54078.75
Supervision charges — 8% over all	= 1802625.00 × 8/100 = Rs. 144210.00
Grand Total	Rs. 2000913.75

**Example 2**—Prepare a preliminary estimate of a four storied office building having a carpet area of 2000 sq m for obtaining the administrative approval of the Government given the following data. It may be assumed that 30 per cent of the built up area will be taken up by the corridors verandahs lavatories, staircases, etc., and 10% of the built up area will be occupied by walls.

- Plinth area rate is — Rs. 950.00 per sq m
- Extra due to deep foundation at site — 1% of building cost.
- Extra for special Architectural treatment 0.5% of building cost.
- Extra for water supply and Sanitary installations — 6% of building cost.
- Extra for Electric installations — 12.5% of building cost.
- Extra for other services 5% of building cost.
- Contingencies — 2½%
- Supervision charges — 8%

Built up area or Plinth area = Carpet area + area occupied by corridors, (verandahs, lavatories, staircases, etc.) + area occupied by walls.

Let  $x$  be the built up area or plinth area

Then  $x$  = carpet area + 30% of built up area + 10% of built up area.

$$\text{Or } x = 2000 \text{ sq m} + 30/100 \times x + 10/100 \times x$$

$$\text{Or } x = 2000 + 3x/10 + 10x/100 \text{ or } 10x = 20000 + 3x + x, \text{ Or } 6x = 20000$$

$$x = 3333\frac{1}{3} \text{ sq m} = \text{Built up area or Plinth area.}$$

Building cost — 3333 $\frac{1}{3}$ sq m @ Rs. 950.00 per sq m = 3333 $\frac{1}{3}$ × 950.00	Rs. 3166663.50
Extra for deep foundation — 1% of building cost = 3166663.50 × 1/100 =	Rs. 31666.65
Special Architectural treatment — 0.5% of building cost	= 3166663.50 × 0.5/100 = Rs. 15833.32
Water Supply and Sanitary installations — 6% of building cost	= 3166663.50 × 6/100 = Rs. 189999.81
Electric installations — 12.5% of building cost = 3166663.50 × 12.5/100 =	Rs. 395832.93
Other services — 5% of building cost	= 3166663.50 × 5/100 = Rs. 158333.17
Total	Rs. 3958328.22
Contingencies — 2½% over all	= 3958328.88 × 2½/100 = Rs. 98958.22
Supervision charges — 8% over all	= 3958328.88 × 8/100 = Rs. 316666.30
Grand Total	Rs. 4373953.00

**Example 3.**—Prepare a preliminary estimate for administrative approval of the Government for a Hospital project to serve both indoor and outdoor patient in an important rural area. The Hospital will consist of the following :—

(1) Main administrative office with dispensing operation, etc.; (2) Two general wards each of 20 general beds, and 2 private beds; (3) Superintendent Doctor's residence; (4) Two Assistant Doctor's residence; (5) Eight single Nurses quarters; (6) Four Compounder's quarters; (7) Twelve Peon's quarters etc.

Provision for internal, electrical, sanitary and water supply installations, and for external services road—water supply, sanitary electrifications, storm water drains, fencing, arboriculture, etc., shall have to be made.

Assuming suitable Plinth area of the building, Plinth area rate, other rates, etc, the estimated cost works out as follows :—

	Plinth Area	Rate	Cost
<b>Buildings —</b>			
(1) Main building consisting of administrative office, Doctor's rooms, office rooms, waiting consultation, examination, dispensing operation, X-ray, store, sanitary accommodation etc.	650 sq. m.	Rs. 1000.00/sqm	Rs. 650000.00
(2) Two General wards each with 20 general beds and 2 private beds with nurses duty room, side store room, sanitary annex, etc. each of 500 sq m plinth area.	1000 sq m	1000.00/sq m	1000000.00
(3) Supnt. Doctor's Residence 1 quarter	160 sq m	950.00/sq m	152000.00
(4) Asstt. Doctor's Residence two semi-detached quarters of 10 sq m each	260 sq m	950.00/sq m	247000.00
(5) 3 Nurse's quarters One block of 8 single room quarters with attached bath and W.C. with common mess and kitchen	300 sq m	900.00/sq m	270000.00
(6) 4 Compounder's quarters—Two block of 100 sq m plinth area	200 sq m	900.00/sq m	180000.00
(7) 12 single room quarters for ward boys, peons, sweepers etc. Three blocks of 4 single room quarters with cooking verandah, each block of 100 sq m plinth area	300 sq m	900.00/sq m	270000.00
(8) A Mortuary	25 sq m	900.00/sq m	22500.00
		<b>Total</b>	<b>2791500.00</b>
Internal sanitary and water supply works 8% of building cost			223320.00
Internal electric wiring 8% of building cost			223320.00
		<b>Total</b>	<b>3238140.00</b>

**Land and other service (Ex. 3 Contd.)**

(i) Cost of land including compensation acquisition cost @ 5% of the building cost	Rs. 161907.00
(ii) Preliminary works, surveying, etc. @ 1/2% of the building cost	Rs. 16190.70
(iii) Levelling and dressing of land @ 1/2% of the building cost	Rs. 16190.70
(iv) Cost of road with bituminous topping @ 4% of the building cost	Rs. 129525.00
(v) Cost of sewer and sewage disposal works @ 3% of the building cost	Rs. 97144.20
(vi) Cost of water supply, tube well, overhead tank, pump, pipe line etc. @ 9% of the building cost	Rs. 161907.00
(vii) External electric service line @ 2% of the building cost	Rs. 64762.80
(viii) Cost of storm—water drain fencing, etc. @ 2% of the building cost	Rs. 64762.80
(ix) Cost of providing Arboriculture @ 1/2% of the building cost	Rs. 161907.00
<b>Total of land and External service</b>	<b>Rs. 874297.20</b>
<b>Total of Building, Land and External services</b>	<b>Rs. 4112437.20</b>
Contingencies 3% over all excluding cost of land	Rs. 123373.11
Supervision or Department charges 10% over all excluding cost of land	Rs. 411243.72
<b>Grand Total of all</b>	<b>Rs.4647854.00</b>

**Note—**(1) The percentage rates in the above are only approximate and will vary according to the nature of the work or project.

(2) The preliminary estimate should be supported with layout plan and line plan of buildings.

(3) If the lay out plan is prepared by preliminary surveying and showing the positions of buildings, roads, etc. then the estimate for the external services may be prepared more correctly by kilometre basis taking length from the layout plan and assuming rates per kilometre. The area of land should be as per layout plan and the cost of land should be worked out on the basis of rate of land prevalent in the locality.

(4) If the area of land is known or assumed suitable, then the cost of land and external services may also be estimated approximately on the basis of rates per hectare of land area as —

(i) Cost of land @ Rs. 10000/- per hectare, (ii) Preliminary work @ Rs. 2000/- per hectare, (iii) Levelling of land @ Rs. 2000/- per hectare, (iv) Cost of roads @ 15000/- per hectare, (v) Cost of sewer @ Rs. 15,000/- per hectare, (vi) Cost of water supply works @ Rs. 25,000/- per hectare, (vii) External electric lines @ Rs. 8000/- per hectare, (viii) Storm water drains @ Rs. 9000/- per hectare, (ix) Arboriculture @ Rs. 2000/- per hectare.

At the end 3% for Contingencies and 10% for supervision may be added.

**Example 4**—Prepare a Preliminary Project Estimate for a new Polytechnic for 100 intake in Civil, 60 Mechanical and 60 Electrical. Necessary accommodation as per standard shall be provided. Two blocks of Hostels to accommodate 300 students in double seated rooms shall be provided with necessary common room, dining room, kitchen, sanitary accommodation, etc. Adjacent to each block of Hostel there will be two hostel Warden's Quarter.

Residential accommodation shall be provided for—The principal, 3 Lecturers, 2 Instructors, 3 Clerks and 16 Class IV Staff members.

Necessary provision shall be made for land and other external services.

### POLYTECHNIC BUILDING

I. Administrative Block including Class Rooms, Drawing Halls, etc.—		III. Students Amenities—	
	Carpet Area		Carpet Area
1. Principal's room	30 sq m	1. Canteen and Tuck shop	200 sq m
2. Staff rooms for senior Lecturers and Lecturers	200 sq m	2. Dispensary	35 sq m
3. Office	125 sq m		
4. Confidential room for Cyclotyping and Examination papers	10 sq m		
5. Library and Reading room	225 sq m		
6. Stores	175 sq m		
7. Model room	105 sq m		
8. Staff common room	75 sq m		
9. Students common room	100 sq m		
10. Class rooms 7 nos. each of 75 sq m	525 sq m		
11. Drawing Halls 7 nos. each of 120 sq m	840 sq m		
<b>Total Carpet Area</b>	<b>2410 sq m</b>		
		<b>Total Carpet Area</b>	<b>235 sq m</b>
		<b>Total carpet area of I, II and III which will be in pucca building</b>	<b>3045 sq m</b>
		<b>Add 40% for conversion into plinth area (for circulation, Sanitary accommodation, Walls, etc.)</b>	<b>1478 sq m</b>
		<b>(A)—Total Plinth Area for I, II and III</b>	<b>5173 sq m</b>
		<b>IV. Workshop, Hydraulic Lab and Heat Engine Lab</b>	
		1. Heat Engine Lab.	350 sq m
		2. Hydraulic Lab.	120 sq m
		3. Carpentry	90 sq m
		4. Smithy	100 sq m
		5. Fitting	90 sq m
		6. Welding, Painting Sheet-metal, Masonry and Plumbing (each 50 sq m)	250 sq m
		7. Foundry	100 sq m
		8. Machine Shop	250 sq m
		<b>Total of floor area which will be in shed with sloping roof</b>	<b>2150 sq m</b>
		<b>Add 10% for conversion into plinth area</b>	<b>135 sq m</b>
		<b>(B)—Total Plinth Area for IV</b>	<b>1485 sq m</b>

II. Laboratories—	
1. Science Labs. (Physics and Chemistry)	300 sq m
2. Material Testing and Applied Mech. Lab.	240 sq m
3. Civil Engineering Lab.	85 sq m
4. Surveying Lab.	75 sq m
5. Electrical Lab. (Machines, Instruments and Electric workshops)	350 sq m
<b>Total Carpet Area</b>	<b>1050 sq m</b>

### Hostel Building for 300 students—

	Plinth Area	Residential Accommodation—	Plinth Area
1. Living floor area @ 8 sq m per student	2400 sq m	1. Principal's Quarter	160 sq m
2. Common and reading room @ .5 sq m per student	150 sq m	2. Lecturer's Quarter 3 nos. 100 sq m per Quarter	300 sq m
3. Dining room @ .7 sq m per student	220 sq m	3. Hostel Warden's Quarter @ 70 sq m per quarter	140 sq m
4. Kitchen @ .6 sq m per student	180 sq m	4. Instructor's Qrs. 12 no. @ 60 sq m per Quarter	720 sq m
5. W.C. block @ .6 sq m per student	180 sq m	5. Clerk's Quarters 6 nos. @ 50 sq m per Quarter	300 sq m
<b>Total floor area</b>	<b>3120 sq m</b>	6. Class IV Staff Quarters 16 nos. @ 25 sq m per Quarter	400 sq m
<b>Add 40% for conversion into plinth area (for circulation, wall etc.)</b>	<b>1248 sq m</b>	<b>(D)—Total Plinth Area</b>	<b>2520 sq m</b>
<b>(C)—Total Plinth Area</b>	<b>4368 sq m</b>		

### COST

(A) Administrative Block with Class Rooms Drawing Halls (I) Laboratories (II) and Students Amenities (III). Total plinth area 5173 sq m @ Rs. 950.00 per sq m	-Rs.	4914350.00
(B) Workshop Hydraulic Lab. and Heat Engine Lab. (IV) Total plinth area 1485 sq m @ Rs. 550.00 per sq m	-Rs.	816750.00
(C) Hostel building for 300 students, Total plinth area 4368 sq m @ Rs. 900.00 per sq m	-Rs.	3931200.00
(D) Residential Quarters Total plinth area 2520 sq m @ Rs. 900.00 per sq m	-Rs.	2268000.00
<b>Total for building work</b>	-Rs.	11930300.00
Internal sanitary and water supply works @ 8% of building work	-Rs.	954424.00
Internal electric wiring @ 8% of building cost	-Rs.	954424.00
Electric Fans for Administrative blocks etc. @ 4% of cost against (A)	-Rs.	477212.00
<b>Total</b>	-Rs.	1436360.00
Cycle shed and stands	-Rs.	10000.00
Land assuming 20 hectares @ Rs. 10000.00 per hectare	-Rs.	200000.00
External services for levelling Roads Sewers, Water supply works, Electric service lines, drains etc. @ 15% of building cost i.e. 15% of Rs. 1436360.00	-Rs.	2147454.00
<b>Total</b>	-Rs.	16673814.00
Add for Contingencies 3%	-Rs.	500214.42
Add for Supervision or Department Charges 10%	-Rs.	1667381.40
<b>Total</b>	-Rs.	18841409.82
Add for Furnitures for Polytechnic and Hostel building	-Rs.	200000.00
Add for Library books	-Rs.	300000.00
Add for Equipments and Plans	-Rs.	300000.00
<b>Grand Total</b>	-Rs.	22241409.82
	Say	Rs. 222.41 lakhs

Note.—For Plinth Area of various class of Residential Buildings, See Chapter 18—Planning of Buildings.

Taking charges of a bullock cart as Rs. 50.00 per day of 8 hours working. Cost per trip =  $\frac{\text{Rs. } 50.00}{2.13}$   
= Rs. 23.50.

Taking loading capacity per bullock cart as 0.8 cu m, number of trips required per unit of 1 cu m =  $\frac{1}{0.8} = 1.25$  no. Therefore, cost of carriage per unit of 1 cu m = Rs. 23.50 × 1.25 = Rs. 29.40. Adding 10% contractor's profit the rate per cu m = Rs. 29.40 + 2.94 = Rs. 32.84.

**Example 7.**—Calculate the rate per unit (1 cu m) for carriage of materials—Sand, surkhi, lime, grit, ballast, kankar, etc., by truck for a lead of 15 km.

Take loading capacity of truck as 3.5 cu m of material.

**Speed of truck**—Speed of truck for first 1 km lead = 10 km per hour. For subsequent lead of 14 km at  $\frac{1}{2}$  km per hour for each additional lead of 1 km = 7 km per hour. Therefore, average speed for a lead of 15 km = 17 km per hour. Thus, speed S = 17, and lead L = 15.

**Number of Trips per day of (8 hours working day), N** = 
$$\frac{8 \times 8}{\frac{2L}{S} + \frac{3}{4} + \frac{2 \times 15}{17} + \frac{3}{4}} = 3.18 \text{ nos.}$$

**Total km done per day (both ways allowing 6 km for parking)** =  $2NL + 6 = 2 \times 3.18 \times 15 + 6 = 101.4 \text{ km.}$

**Petrol.**—Petrol consumption for 101.4 km at 3 km per litres =  $101.4 / 3 = 33.8$  litre. Cost of Petrol 33.8 litres @ Rs. 7.50 per litre = Rs. 7.50 × 33.8 = Rs. 253.50.

**Mobil oil.**—Mobil oil consumption for 101.4 km at 100 km per litre =  $101.4 / 100 = 1.01$  litre. Cost of Mobil oil 1.01 litre at Rs. 20.00 per litre = 20.02.

**Labour.**—Cost of labour for loading and unloading materials 6 Mazdoor (Beldar) @ Rs. 18.00 each per day = Rs. 108.00.

**Hireage of Truck.**—Hire charge of Truck including driver and cleaner—Rs. 350.00 per day of 8 hours.

**Total Cost.**—Adding Total Cost—Rs. 253.50 + Rs. 20.02 + Rs. 108.00 + Rs. 350.00 = Rs. 731.52. Adding 10% contractor's profit. Total Cost = Rs. 731.52 + Rs. 73.15 = Rs. 804.67.

**Cost per trip** +  $\frac{\text{Total Cost}}{\text{Number of Trips}} = \frac{\text{Rs. } 804.67}{3.18} = \text{Rs. } 253.04.$

**Rate per cu m.**—Loading capacity of truck is 3.5 cu m of materials.  
Therefore cost of carriage per cu m =  $\frac{\text{Cost per trip}}{\text{Carrying capacity}} = \frac{\text{Rs. } 253.04}{3.5 \text{ cu m}} = \text{Rs. } 72.30 \text{ per cu m.}$

## CHAPTER 13 SPECIFICATIONS

Specification specifies or describes the nature and the class of the work, materials to be used in the work, workmanship, etc., and is very important for the execution of the work. The cost of a work depends much on the specifications. Specifications should be clear, and there should not be any ambiguity anywhere. From the study of the specifications one can easily understand the nature of the work and what the work shall be. The drawings of a building or structure show the arrangement of the rooms and various parts, and the dimensions—length, breadth and height, with very brief descriptions of different parts. Drawings do not furnish the details of different items of work, the quantity of materials, proportion of mortar and workmanship which are described in specifications. Thus the combinations of drawings and specifications define completely the structure. Drawings and specifications form important parts of contract document.

During writing specification attempts should be made to express all the requirements of the work clearly and in a concise form avoiding repetition. As far as possible, the clauses of the specification should be arranged in the same order in which the work will be carried out. The specifications are written in a language so that they indicate what the work should be, and words "shall be" or "should be" are used.

Specifications depend on the nature of the work, the purpose for which the work is required, strength of the materials, availability of materials, quality of materials, etc.

Specifications are of two types :—

(1) General specification or Brief specification, and (2) Detailed specification.

**General or brief specification.**—General specification gives the nature and class of the work and materials in general terms, to be used in the various parts of the work, from the foundation to the superstructure. It is a short description of different parts of the work specifying materials, proportions, qualities, etc. General specifications give general idea of the whole work or structure and are useful for preparing the estimate.

For general idea, the general specifications of different class of buildings are given below. These will of course vary according to the necessity and type of works.

### 1. I. General Specifications of a First Class Building

**Foundation and plinth.**—Foundation and plinth shall be of 1-class brickwork in lime mortar or 1 : 6 cement mortar over lime concrete or 1 : 4 : 8 cement concrete.

**Damp proof course.**—D.P.C. shall be 2.5 cm (1") thick cement concrete 1:1½:3, mixed with one kg of Impermo per bag of cement or other standard water proofing materials as specified and painted with two coats of bitumen.

**Superstructure.**—Superstructure shall be of 1-class brickwork with lime mortar or 1 : 6 cement mortar. Lintels over doors and windows shall be of R.C.C.

**Roofing.**—Roof shall be of R.C.C. slab with an insulation layer and lime concrete terracing above, supported over R.S. Joists or R.C.C. beams as required. Height of rooms shall not be less than 3.7 m (12 feet).

**Flooring.**—Drawing room and dining room floors shall be of mosaic (terrazo). Bathroom and W.C. floors and dado shall be of mosaic (terrazo). Floors of bedrooms shall be coloured and polished of 2.5 cm (1") cement concrete over 7.5 cm (3") lime concrete. Floors of others shall be of

2.5 cm (1") cement concrete over 7.5 cm (3") lime concrete polished.

**Finishing**—Inside and outside walls shall be of 12 mm ( $\frac{1}{2}$ ") cement lime plastered 1 : 1 : 6. Drawing, dining and bedrooms—inside shall be distempered, and others—inside white washed 3 coats. Outside shall be coloured snowcem washed two coats over one coat of white wash.

**Doors and windows**—Chaukhats shall be seasoned teak wood. Shutters shall be teak wood 4.3 cm ( $1\frac{3}{4}$ ") thick panelled glazed or partly panelled and partly glazed as required, with additional wire gauge shutters. All fittings shall be of brass. Doors and windows shall be varnished or painted two coats with high class enamel paint over one coat of priming. Windows shall be provided with iron gratings or grills.

**Miscellaneous**—Rain water pipes of cast iron or of asbestos cement shall be provided and finished painted. Building shall be provided with 1st class Sanitary and Water fittings and Electrical installations. 1 metre wide 7.5 cm thick C.C. 1 : 3 : 6 apron shall be provided all round the building.

### II. General Specifications of a Second Class Building

**Foundation and plinth**—Foundation and plinth shall be of 1st class brickwork with lime mortar over lime concrete.

**Damp proof course**—D.P.C. shall be of 2 cm ( $\frac{3}{8}$ ") thick cement concrete 1 : 2 mixed with 1 kg of Impermo per bag of cement or other standard water proofing materials.

**Superstructure**—Superstructure shall be of 2nd class brickwork in lime mortar. Lintels over doors and windows shall be of R.B.

**Roofing**—Roof shall be R.B. slab with 7.5 cm lime concrete terracing above (or flat terraced roof supported over wooden battens and beams, or Jack arch roof). Verandah roof may be of A.C. sheet or Allahabad tiles.

**Flooring**—Floors shall be 2.5 cm (1") cement concrete over 7.5 cm (3") L.C. Verandah floor shall be of brick tile or flag stone over lime concrete, finished cement painted.

**Finishing**—Inside and outside walls shall be of 12 mm cement mortar plastered 1 : 6. Ceiling shall be cement plastered 1 : 3. Inside shall be white washed 3 coats, colour washed two coats over one coat of white wash.

**Doors and windows**—Chaukhat shall be of R.C.C. or well seasoned sal wood, shutters of shisham wood or deodar wood 4 cm ( $1\frac{1}{2}$ ") thick, panelled, glazed or partly panelled and partly glazed as required, fitted with iron fittings. Doors and windows shall be painted two coats over one coat of priming.

**Miscellaneous**—Rain water pipes shall be of cast iron finished painted. Electrification, and sanitary and water fittings may be provided if required.

### III. General Specifications of a Third Class Building

**Foundation and plinth**—Foundation and plinth shall be of 2nd class brickwork in lime mortar over lime concrete. Damp proof course shall be 2 cm thick cement mortar 1 : 2 mixed with standard water proofing compound.

**Superstructure**—Superstructure shall be of second class brickwork in mud mortar. Door and window opening shall be provided with arches of 2nd class brickwork in lime mortar or with wooden planks.

**Roofing**—Roof shall be of mud over tiles or bricks or planks over wooden beams or of tile or G.I. sheet or A.C. sheet sloping roof.

**Flooring**—Floor shall be of brick-on-edge floor over well rammed earth.

**Finishing**—Inside and outside walls shall be plastered with lime mortar and white washed three coats.

**Doors and windows**—Chaukhat shall be of salwood, and shutters of chir mango or other country wood. Doors and windows shall be painted two coats with ordinary paint over one coat of priming.

### IV. GENERAL SPECIFICATIONS OF A FOURTH CLASS BUILDING

**Foundation and superstructure**—Foundation and superstructure shall be of sun-dried or kutchha bricks in mud mortar. Door and window openings shall be provided with arches of 2nd class brickwork in lime mortar or with wooden planks. Inside and outside shall be water proof mud plastered.

**Roofing**—Roof shall be of tile roof over bamboo and wooden supports.

**Flooring**—Floor shall be kutchha or earthen floor finished with "gobri" washing (cowdung lepping).

**Doors and windows**—Doors and windows shall be of chir or mango wood, or country wood.

(See also Specifications of Village House, Chapter 19)

### DETAILED SPECIFICATIONS

The detailed specification is a detailed description and expresses the requirements in detail.

The *detailed specification* of an item of work specifies the qualities and quantities of materials, the proportion of mortar, workmanship, the method of preparation and execution and the methods of measurement. The detailed specifications of different items of work are prepared separately, and describe what the works should be and how they shall be executed and constructed. Detailed specifications are written to express the requirements clearly in a concise form avoiding repetition and ambiguity. The detailed specifications are arranged as far as possible in the same sequence of order as the work is carried out. The detailed specifications if prepared properly are very helpful for the execution of work. The *detailed specifications* form an important part of contract document.

Every engineering department prepares the *detailed specifications of the various items of works, and get them printed in book form under the name 'Detailed Specifications'*. When the work, or a structure or project is taken up, instead of writing detailed specification every time, the printed *Detailed Specifications* are referred.

The detailed specifications of various items of works are as follows :—

#### 1. Earthwork in excavation in foundation—

**Excavation**—Foundation trenches shall be dug out to the exact width of foundation concrete and the sides shall be vertical. If the soil is not good and does not permit vertical sides, the sides should be sloped back or protected with timber shoring. Excavated earth shall not be placed within 1 m (3') of the edge of the trench.

**Finish of trench**—The bottom of foundation trenches shall be perfectly levelled both longitudinally and transversely and the sides of the trench shall be dressed perfectly vertical from

bottom up to the least thickness of loose concrete so that concrete may be laid to the exact width as per design. The bed of the trench shall be lightly watered and well rammed. Excess digging if done through mistake shall be filled with concrete at the expense of the contractor. Soft or defective spots shall be dug out and removed filled with concrete or with stabilized soil. If rocks or boulders are found during excavation, these should be removed and the bed of the trenches shall be levelled and made hard by consolidating the earth. Foundation concrete shall not be laid before the inspection and approval of the trench by the engineer-in-charge.

**Finds—**Any treasure and valuables or materials found during the excavation, shall be property of the Government.

**Water in foundation—**Water, if any accumulates in the trench, should be bailed or pumped out without any extra payment and necessary precautions shall be taken to prevent surface water to enter into the trench.

**Trench filling—**After the concrete has been laid masonry has been constructed the remaining portion of the trenches shall be filled up with earth in layers of 15 cm (6") and watered and well rammed. The earth filling shall be free from rubbish and refuse matters and all clods shall be broken before filling. Surplus earth not required, shall be removed and disposed, and site shall be levelled and dressed.

**Measurement—**The measurement of the excavation shall be taken in cu m (cu ft) as for rectangular trench bottom width of concrete multiplied by the vertical depth of foundation from ground level and multiplied by the length of trenches even though the contractor might have excavated with sloping side for his convenience. Rate shall be for complete work for 30 m (100 ft) lead and 1.50 m (5') lift, including all tools and plants required for the completion of the works. For every extra lead of 30 m and every extra lift of 1.5 m separate extra rate is provided.

**Excavation in saturated soil—**Excavation in saturated soil or below sub-soil water level shall be taken under a separate item and shall be carried out in the same manner as above. Pumping or bailing out of water and removal of slush shall be included in the item. Timbering of the sides of trenches if required shall be taken under a separate item and paid separately.

**Note—**Excavation in different kinds of soil mixed with mooram or kankar or shingle, soft rock or decomposed rock or shale hard rock, etc., shall be taken under separate items. The excavation shall be done on the same principle as above item 1.

## 2. Lime concrete in foundation—

**Materials—**All materials shall be as per standard specifications. Course aggregate shall be of hard, well-burnt or overburnt brick ballast of 40 mm gauge. It shall be deep cherry red or copper colour, and shall be clean, free from dust, dirt, and other foreign matters. It shall be homogeneous in texture and roughly cubical in shape. Ballast which appears porous or shows signs of saltpetre shall not be used. Brick ballast shall pass through square mesh of 52.5 mm and not more than 20 per cent shall pass through a mesh of 25 mm. Any rejected material shall be removed from site of work within 24 hours.

Fine aggregate shall be of surkhi or sand or cinder as specified, and clean and free from dust, dirt, and foreign matters. Surkhi shall be made of well burnt bricks or brick bats (not overburnt) and shall pass through a sieve of 2.5 meshes per sq cm. (144 meshes per sq in). Surkhi is preferable for better concrete.

Lime shall be white fat lime (unless otherwise specified) and shall be freshly burnt and free from ashes and other foreign matters. Lime shall be slacked at site of work and screened through a sieve of 3 meshes to a cm (8 meshes to an inch).

**Proportion—**The concrete shall consist of 1 cu m of brick ballast, 0.32 cu m of surkhi (sand or cinder) and 0.16 cu m of white lime in the proportion of 100 : 32 : 16 by volume.

**Mixing—**Mixing shall be done on a clean watertight, masonry platform of sufficient size. Brick ballast shall be stacked in a rectangular layer of uniform thickness usually 30 cm (12") high and well soaked with clean water for a period of at least three hours.

Lime and surkhi (or sand or cinder) shall be measured with wooden box in the proportion 1 : 2 and mixed thoroughly dry to have uniform colour. The dry mix of lime and surkhi (or sand or cinder) shall be spread over the stacked ballast to the required thickness to give the specified proportion. The materials shall then be mixed dry turning at least three times. Clean water shall then be added slowly and gradually by water-can to the required quantity while mixing and the materials mixed thoroughly becomes plastic of uniform colour of workable consistency and should be such that the ballast do not separate from the mortar. Concrete shall be mixed only for day's work, old and stale concrete shall not be used. For big work the mixing shall be done by machine. In this case aggregate and wet mortar shall be poured in the drum, while it is revolving. The water shall be added slowly to the required quantity and the mixing shall be continued for at least one minute, till a mix of uniform colour and workable consistency is obtained and should be such that the ballast do not separate from the mortar.

**Laying and compacting—**Bed of foundation trench shall be lightly sprinkled with water before concrete is laid. Concrete shall be laid slowly and gently (not thrown) in layers of not more than 20 cm (8") and thoroughly consolidated to 15 cm (6") with 6 kg (12 lbs) iron rammers. During consolidation concrete should be kept free from earth, dirt, leaves and other foreign matters. The consolidation shall be checked by water test, by digging a hole of about 7.5 cm dia. and 7.5 cm deep in the concrete and filling water. The water level should not sink more than 1.25 cm in 15 minutes if concrete has been well-consolidated.

**Joint and consecutive layers—**When joint in a layer of concrete are unavoidable, the end shall be sloped at an angle of 30° and junctions of different layers shall break joint. In laying upper layer of concrete, the lower surface shall be made rough and cleaned and watered before upper layer is laid.

**Curing—**Concrete after completion shall be kept wet for a period of at least 7 days and no masonry shall be constructed upon it during this period. The curing shall be done by spreading gunny bags or sand or keeping them wet by water-can at regular interval.

**Measurement—**Measurement shall be taken in cu m (cu ft) for the finished concrete. The length and breadth shall be measured correct to 1 cm and depth correct to 0.5 cm. The rate shall be for the complete work including the cost of form work if required, and all tools and plants.

**Note—**If kankar lime is used 0.35 cu m of kankar lime shall be used with 1 cu m ballast (35 cu m kankar lime with 100 cu m ballast) and no surkhi or sand or cinder shall be added.

When brick ballast is not available, in hill areas, stone ballast 40 mm (1½") gauge, sand and white lime may be used in the same proportion as above.

## 3. Lime concrete in roof terracing—

**Materials—**All materials shall be of standard specifications. Course aggregate shall be of well burnt or overburnt brick ballast of 25 mm gauge. It shall be deep cherry red or copper colour and shall be clean, free from dust, dirt and other foreign matters. It shall be homogeneous in texture and roughly cubical in shape. Ballast which appears porous or shows signs of saltpetre shall not be used. Brick ballast shall be such as to pass through a square mesh of 37.5 cm and not more than 20 per cent shall pass through a mesh of 20 cm. Any rejected material shall be removed from site of work within 24 hours.

Fine aggregate shall be of surkhi, clean free from dust, dirt and foreign matters. Surkhi shall be made from well burnt bricks or brick bats (not overburnt) and shall pass through a screen of 25 meshes per sq cm (144 meshes per sq in).



Lime shall be white fat lime and shall be freshly burnt and free from ashes and other foreign matters. Lime shall be slaked at site of work and screened through a sieve of 3 meshes to a cm (8 meshes to an inch).

*Proportion*—Concrete shall consist of 1 cu m brick ballast, 0.36 cu m of surkhi and 0.18 cu m white lime (proportion 100 : 36 : 18 by volume).

*Mixing*—Mixing shall be similar to lime concrete in foundation (item 2).

*Laying and consolidation*—Surface shall be lightly sprinkled with water and then concrete shall be laid slowly and gently (not thrown) in layers so as to have the required slope and specified thickness after compaction. The concrete shall then be lightly rammed with 6 kg (12 lbs) rammers and during preliminary ramming the surface shall then be perfectly levelled by means of trowel, straight edge and spirit level. The concrete shall then be kept further consolidated by two rows of labourers sitting close and beating the concrete with wooden 'thapis' and moving forward and backward covering the whole surface. The beating shall continue for at least seven days until the concrete is thoroughly compacted and until the 'thapis' rebound from the surface when struck on the concrete. Special care shall be taken to consolidate the concrete properly at the junction with the parapet wall and the junctions shall be rounded.

When beating is in progress, the surface of the concrete shall be frequently sprinkled with a mixture of lime molasses and boiled solution of 'bael' fruit for water proofing. Bael fruit solution shall be prepared by boiling 2 kg of bael fruit in 100 to 130 litres of water and to this solution after cooling 3.5 kg of molasses (gur) and the required quantity of lime shall be mixed.

*Finishing*—As soon as beating has been completed the mortar that has come to top shall be softened by the addition of lime, 'molasses' and 'bael fruit' solution and smoothed by rubbing and pressing with a trowel or float to a fine polish. No plaster shall be used on any account for finishing the surface. The finished surface shall have a minimum slope of 1 in 50 and maximum slope of 1 in 36 towards the rainwater outlet. For every 40 sq m of roof area, 100 mm diameter rainwater pipe shall be provided.

*Curing*—The concrete shall be kept wet for a fortnight. The wetting should be done by covering with straw or sand and watering frequently by water-can or dividing into squares by mud kiaries which shall be kept flooded with water.

*Measurement*—The measurement shall be taken for the finished work of superficial area in sq m (sq ft) stating the average thickness. The average thickness shall be measured correct to 6 mm and length and breadth shall be measured correct to 1 cm. No deduction in measurement shall be made for opening up to 0.4 sq m and extra payment shall not be made for extra material or labour involved in forming such opening. For opening exceeding 0.4 sq m deductions will be made in the measurement but extra payment shall not be made for material and labour involved in forming such opening. Rate shall be for the finished work including all tools and plant.

*Instead of Bael fruit the solution of Terminalia Chebula (kadukai) may be used, as used in South India. Dry nuts of kadukai shall be broken to small pieces, and allowed to soak in water. The solution be prepared to have a proportion of 600 g of kadukai, 200 g of molasses and 40 litres of water for 100 sq m area of roof concrete. The solution is brewed for 12 to 24 hours, and the resulting liquor is decanted and used for the work.*

*Note*—(i) If kankar lime is used, 0.45 cu m of kankar lime shall be mixed with 1 cu m brick ballast (proportion 45 : 100).

(ii) If stone ballast is used the proportion shall be 1 cu m of stone ballast of 25 mm gauge, 0.5 cu m of sand and 0.25 cu m of white lime (proportion 1 : 2 : 4).

(iii) *The finished thickness of lime concrete in roof terracing may be 7.5 cm to 12 cm (3" to 4½").*

(iv) *The surface finishing may be taken in sq m under a separate item.*

#### 4. Cement concrete 1 : 2 : 4—

*Materials*—Aggregate shall be of inert materials and should be clean, dense, hard, sound, durable, non-absorbent and capable of developing good bond with mortar.

Coarse aggregate shall be of hard broken stone of granite or similar stone, free from dust, dirt and other foreign matters. The stone ballast shall be of 20 mm (¾") size and down and all should be retained in a 5 mm square mesh (¼" square) and well graded such that the voids do not exceed 42 per cent. (The gauge of the stone ballast shall be as specified depending on the thickness of concrete and nature of work. For building work 20 mm gauge and for road work and mass work 40 to 60 mm gauge may be used.

Fine aggregate shall be of coarse sand consisting of hard, sharp and angular grains and shall pass through screen of 5 mm (3/16") square mesh. Sand shall be of standard specifications clean and free from dust, dirt, and organic matters. Sea sand shall not be used. (Fine aggregate may also be of crushed stone if specified).

Cement shall be fresh portland cement of standard I.S.I. specifications, and shall have the required tensile and compressive stresses and fineness.

Water shall be clean and free from alkaline and acid matters and suitable for drinking purposes.

*Proportion*—The proportion of concrete shall be 1 : 2 : 4 as cement : sand : stone : ballast by volume unless otherwise specified. Minimum compressive strength of concrete of 1 : 2 : 4 proportion shall be 140 kg per sq cm (2000 lbs/sq in) on 7 days.

Stone aggregate and sand shall be measured by volume with boxes. Cement need not be measured by box, one bag of cement (50 kg) should be considered as 1/30 cu m (1.2 cu ft). Size of measured box may be 30 cm × 30 cm × 38 cm or 35 cm × 35 cm × 28 cm equivalent to content of one bag of cement. All materials shall be dry. If damp sand is used compensation shall be made by adding additional sand to the extent required for the bulking of damp sand. Mixing shall be of machine mixing. For small work hand mixing by batches may be allowed.

*Hand mixing*—Mixing shall be done in masonry platform or sheet iron tray. For concrete of 1 : 2 : 4 proportion, first two boxes of sand and one bag of cement shall be mixed dry thoroughly and then this dry mix of cement and sand shall be placed over a stack of 4 boxes of stone aggregate and the whole mixed dry turning at least three times to have uniform mix. Water shall then be added slowly and gradually with a water-can while being mixed to the required quantity 25 to 30 litres (5 to 6 gallons) per bag of cement, to give a plastic mix of the required workability and water cement ratio. The whole shall be mixed thoroughly turning at least three times to give a uniform concrete.

*Machine mixing*—Stone ballast sand and cement shall be put into the cement concrete mixer to have the required proportion. For concrete of 1 : 2 : 4 proportion first four boxes of stone ballast, then two boxes of sand and then one bag of cement shall be put into the C.C. Mixer, the machine shall then be revolved to mix materials dry and then water shall be added gradually to the required quantity, 25 to 30 litres (5 to 6 gallons) per bag of cement to have the required water cement ratio. The mixing should be thorough to have a plastic mix of uniform colour. It requires 1½ to 2 minutes' rotation for thorough mixing. Mixed concrete shall be unloaded on a masonry platform or on a sheet iron. Output of concrete mixer is 15 to 20 mix per hour.

**Slump**—Regular slump test should be carried out to control the addition of water and to maintain the required consistency. A slump of 7.5 cm to 10 cm (3" to 4") may be allowed for building work, and 4 cm to 3 cm (1½" to 2") may be allowed for road work.

**Formwork**—Formwork centering and shuttering shall be provided as required, as per standard specifications before laying concrete to confine to support or to keep the concrete in position. The inner surface of shuttering shall be oiled to prevent concrete sticking to it. The base and formwork over which concrete to be laid shall be watered by sprinkling water before concrete is laid. Forms should not be removed before 14 days in general, side forms may however be removed after 3 days of concreting. Formworks shall be removed slowly and carefully without disturbing and damaging concrete.

**Laying**—Concrete shall be laid gently (not thrown) in layers not exceeding 15 cm (6") and compacted by pinning with rods and tamping with wooden tampers or with mechanical vibrating machine until a dense concrete is obtained. (For important work mechanical vibrating should be used, for thick or mass concrete immersion type vibrators and for thin concrete surface vibrators should be used for compacting concrete). Over-vibration which will separate coarse aggregate from concrete should be avoided. After removal of the form-work in due time the concrete surface shall be free from honey combing, air holes or any other defect.

Concrete shall be laid continuously, if laying is suspended for rest or for the following day the end shall be sloped at an angle of 30° and made rough for further jointing. When the work is resumed, the previous sloped portion shall be roughened, cleaned and watered and a grout of neat cement shall be applied and the fresh concrete shall be laid. For successive layer the upper layer shall be laid before the lower has set.

**Curing**—After about two hours' laying when concrete has begun to harden, it shall be kept damp by covering with wet gunny bags or wet sand for 24 hours, and then cured by flooding with water making mud walls 7.5 cm (3") high or by covering with wet sand or earth and kept damp continuously for 15 days. If specified, curing may be done by covering concrete with special type of waterproof paper as to prevent water escaping or evaporating.

**Note**—(i) For weak concrete 1 : 3 : 6, 1 : 4 : 8, 1 : 5 : 10, etc., sack measurement and hand mixing in a pucca platform may be allowed as in lime concrete (item 2). For foundation concrete or weak concrete brick ballast or cheap type stone ballast of 40 mm (1½") size may be used.

(ii) Approximate quantity of water required for cement may be taken 30% by weight of cement plus 5% by weight of total aggregate. For concrete compacted by mechanical vibrators the quantity of water shall be reduced by 20%.

### 5. Reinforced cement concrete (R.C.C.)—

**Steel**—Steel reinforcing bars shall be of mild steel or deformed steel of standard specifications and shall be free from corrosion, loose rust scales, oil, grease, paint, etc. The steel bar shall be round and capable of being bent (doubled over) without fracture. Bars shall be hooked and bent accurately and placed in position as per design and drawing and bound together tight with 20 S.W.G. annealed steel wire at their point of intersection. Bars shall be bent cold by applying gradual and even motion, bars of 40 mm (1½") diameter and above may be bent by heating to dull red and allowed to cool slowly without immersing in water or quenching. Joints in the bar should be avoided as far as possible, when joints have to be made an overlap of 40 times diameter of the bar shall be given with proper hooks at ends and joints should be staggered. Bigger diameter bars should be joined by welding and tested before placing in position. While concreting steel bars shall

be given side and bottom covers of concrete by placing precast cover blocks underneath of 1 : 2 cement mortar 2.5 cm × 2.5 cm (1" × 1") in section and thickness of specified cover, 4 cm to 5 cm (1½" to 2") for beam and 1 cm to 2 cm (½" to ¾") for slab. During laying and compacting of concrete the reinforcing bars should not move from their positions and bars of the laid portions should not be disturbed.

**Centering and shuttering**—Centering and shuttering shall be made with timber or steel plate close and tight to prevent leakage of mortar, with necessary props, bracings and wedges, sufficiently strong and stable and should not yield on laying concrete and made in such a way that they can be slackened and removed gradually without disturbing the concrete. No plastering should be made on the concrete surface. A coat of oil washing should be applied over the shuttering or paper should be spread to have a smooth and finished surface and to prevent adherence of concrete. For slab and beam small camber should be given in centering, 1 cm per 2.5 m (½" per 10 ft) with a maximum of 4 cm (1½"). Centering and shuttering should not be removed before 14 days in general (4 days for R.C.C. columns, 10 days for roof slab, and 14 days for beams). The centering and shuttering shall be removed slowly and carefully so that no part is disturbed or damaged. (For details of centering and shuttering see item 29).

**Proportion of cement concrete**—Cement concrete shall be of 1 : 2 : 4 proportion by volume for slabs, beams and lintels, and 1 : 1½ : 3 proportion for columns unless otherwise specified.

**Materials for concrete**—Cement, sand and coarse aggregate shall be same as for cement concrete in item 4. the stone aggregate shall usually be 20 mm to 6 mm (¾" to ¼") gauge unless otherwise specified. For heavily reinforced concrete members as in the case of ribs of main beams the maximum size of aggregate should usually be restricted to 5 mm less than the minimum clear distance between the main bars or 5 mm less than the minimum cover to the reinforcement whichever is smaller. Where the reinforcement is widely spaced, limitations of the size of the aggregate may not be so important.

**Mixing**—Same as for cement concrete in item 4.

**Laying**—Before laying the concrete, the shuttering shall be clean, free from dust, dirt and other foreign matters. The concrete shall be deposited (not dropped) in its final position. In case of columns and walls it is desirable to place concrete in full height if practical so as to avoid construction joints but the progress of concreting in the vertical direction shall be restricted to one metre per hour. Care should be taken that the time between mixing and placing of concrete shall not exceed 20 minutes so that the initial setting process is not interfered with. During winters concreting shall not be done if the temperature falls below 4°C. Concrete shall be protected by frost and concrete affected by frost shall be removed and work redone.

Concrete shall be compacted by mechanical vibrating machine until a dense concrete is obtained. The vibration shall continue during the entire period of placing concrete. Compaction shall be completed before the initial setting starts, i.e., within 30 minutes of addition of water to the dry mixture. Over-vibration which will separate coarse aggregate from concrete shall be avoided. After removal of the form work in due time, the concrete surface shall be free from honey combing, air holes or any other defect.

Concrete shall be laid continuously, if laying is suspended for rest or the following day, the end shall be sloped at an angle of 30° and made rough for future jointing. When the work is resumed, the previous sloped position shall be roughened, cleaned and watered and a coat of neat cement shall be applied and the fresh concrete shall be laid. For successive layer the upper layer shall be laid before the lower layer has set.

Structures exceeding 45 metres in length shall be divided by one or more expansion joints. Structures in which plan dimension changes abruptly shall be provided with expansion joints at the

section where such changes occur. Reinforcement shall not extend across an expansion joint at the break between the sections shall be complete.

*Curing*—Same as for cement concrete in item 4.

*Finishing*—If specified the exposed surface shall be plastered with 1 : 3 cement sand mortar not exceeding 6 mm ( $\frac{1}{4}$ " ) thickness and the plastering shall be applied immediately after removal of the centering while the concrete is green. Immediately before applying the plaster the surface of concrete shall be wetted and neat cement wash shall be given.

*Measurement*—Measurement shall be taken in cu m (cu ft) for the finished work and no deduction shall be made for the volume of steel. Steel reinforcement shall be measured under a separate item in quintal (cwt). Plastering, if any, shall not be included in the measurement. The rate for R.C.C. work shall be for the complete work excluding steel but including centering and shuttering and all tools and plants.

*Note*—Student should repeat the specifications of materials, mixing, laying and curing in short as described under cement concrete in item 4.

#### 6. Damp proof course 2.5 cm (1") c.c. 1 : 1½ : 3—

*Materials*—Damp proof course shall consist of cement, coarse sand and stone aggregate of 1 : 1½ : 3 proportion with 2% of *impermo* or *cem-seal*, or *Acco* proof by weight of cement or other standard water proofing compound (1 kg per bag of cement). The damp proof course shall be applied at the plinth level in a horizontal layer of 2.5 cm thickness. The cement shall be fresh portland cement of standard specifications. The sand shall be clean, coarse of 5 mm size and down, and the stone aggregate shall be hard and tough of 20 mm size well graded and free from dust and dirt. (*Composcal*, *puddlo*, *cico* and other standard water proofing compound may be used, and the quantity shall be used as per instruction of the manufacturers.)

*Mixing*—Mixing shall be done in a masonry platform or in a sheet iron tray in the proportion of 1 : 1½ : 3 by measuring with measuring boxes. The cement is first mixed thoroughly with the water proofing compound to the required quantity, and then mixed dry with the sand in the proportion of 1 : 1½. The mix of cement and sand shall then be mixed dry with stone aggregate to have the proportion 1 : 1½ : 3. Clean water shall then be added slowly and gradually while being mixed, to the required quantity to give a plastic mix of the required workable consistency. The mixing shall be done by turning at least three times to give a uniform and homogeneous concrete.

*Laying*—The level of the surface of the plinth shall be checked longitudinally and transversely. The top of walls at damp proof course should be laid with frogs of the brick downward. Side forms or shuttering of strong wooden batten of 2.5 cm thickness shall be fixed properly and firmly on both sides to confine the concrete so that the shuttering does not get disturbed during compaction and mortar does not leak through. The inner edges of the shuttering shall be oiled to prevent concrete adhering to it. The surface of the wall shall be cleaned and the masonry shall be wetted by watering before concrete is laid. The concrete shall be laid within half an hour of mixing and compacted thoroughly by tamping to make dense concrete and levelled both longitudinally and transversely. After two hours of laying the surface of concrete shall be made rough and chequered so as to form a key with the wall above. The damp proof course shall be laid in continuation in one day without any joints. Joints or breaks if unavoidable shall be given at the sills of doors or openings. If joints cannot be avoided the joint shall be sloped and the sloped surface shall be applied with neat cement wash just before starting concreting on the following day. Shuttering may be removed after three days. On removal of the shuttering the edges should become smooth without any honey combing.

*Curing*—The damp proof course shall be cured by watering and kept wet for 7 days, and the construction of wall above may be started. The surface shall be cleaned and wetted before masonry is started.

*Painting with Asphalt*—Two coats of asphalt painting may be applied on the upper surface of damp proof course, if specified. The first coat of hot asphalt at 1.5 kg per sq m (15% kg % sq ft) shall be applied uniformly on the surface when the concrete is dry and the painted surface is blinded immediately with coarse sand and the surface is tamped lightly. The second coat of hot asphalt at 1 kg per sq m (10 kg % sq ft) should then be applied uniformly and the surface is immediately blinded with coarse sand and tamped lightly.

**2 cm Damp proof course.**—The damp proof course may be of 2 cm ( $\frac{3}{4}$ " ) thick layer of 1 : 2 cement and coarse sand mortar with standard water proofing compound at the rate of 1 kg per bag of shuttering shall be 2 cm thick.

#### 7. Brickwork 1 class—

*Bricks*—All bricks shall be of first class of standard specifications made of good brick earth thoroughly burnt, and shall be of deep cherry red or copper colour. Bricks shall be regular in shape and their edges should be sharp and shall emit clear ringing sound on being struck and shall be free from cracks, chips, flaws and lumps of any kind. Bricks shall not absorb water more than one-sixth of their weight after one hour of soaking by immersing in water. Bricks shall have a minimum crushing strength of 105 kg per sq cm (1500 lbs per sq in).

*Mortar*—Mortar shall be specified and materials of mortar shall be of standard specifications.

For cement mortar cement shall be fresh portland cement of standard specifications. Sand shall be sharp, clean and free from organic and foreign matters. For rich mortar coarse or medium sand should be used and for weak mortar local fine sand may be used. Proportion of cement sand mortar may be of (1 : 3 to 1 : 6 as specified). Materials of mortar shall be measured to have the required proportion with measuring box and first mixed dry to have a uniform colour in a clean masonry platform and then mixed by adding clean water slowly and gradually to have workable consistency and mixed thoroughly by turning at least three times. Fresh mixed mortar shall be used, old and stale mortar shall not be used and mortar for one hour's work only shall be mixed with water so that the mortar may be used before setting starts.

Lime surkhi (or sand or cinder) mortar if specified shall be mixed in the specified proportion by grinding in mortar mill for at least three hours on the same day of use. Lime shall be fresh and slaked and screened at site of work. Fresh mixed mortar within 24 hours shall be used, old and stale mortar should not be used. For small work hand mixing may be allowed in the same manner as for cement mortar described above. [Proportion of lime surkhi (or sand or cinder) mortar may be 1 : 2 to 1 : 3 as specified.]

*Soaking of brick*—Bricks shall be fully soaked in clean water by submerging in a tank for a period of 12 hours immediately before use. Soaking shall be continued till air bubbling is ceased.

*Laying*—Bricks shall be well bonded and laid in English bond unless otherwise specified. Every course shall be truly horizontal and wall shall be truly in plumb. Vertical joints of consecutive course shall not come directly over one another, vertical joints in alternate course shall come directly over one another. No damaged or broken bricks shall be used. Closers shall be of clean cut bricks and shall be placed near the ends of walls but not at the other edge. Selected best shape bricks shall be used for face work. Mortar joints shall not exceed 6 mm ( $\frac{1}{4}$ " ) in thickness and joint shall be fully filled with mortar. Bricks shall be laid with frogs upward except in the top course.

where frogs shall be placed downward. Brickwork shall be carried out not more than 1 m (3 ft) height at a time. When one part of the wall has to be delayed, stepping shall be left at an angle of 45°. Corbelling or projections where made should not be more than ¼ brick projections in one course. All joints should be raked and faces of wall cleaned at the end of each day's work.

**Curing**—The brickwork shall be kept wet for a period of at least 10 days after laying. At the end of day's work the tops of walls shall be flooded with water by making small weak mortar edging to contain at least 2.5 cm (1") deep water.

**Protection**—The brickwork shall be protected from the effect of sun, rain, frost, etc., during the constructions and until such time it is green and likely to be damaged.

**Scaffolding**—Necessary and suitable scaffolding shall be provided to facilitate the construction of brick wall. Scaffolding shall be sound and strong and supports and members sufficiently strong so as to withstand all loads likely to come upon them.

**Measurement**—Brickwork shall be measured in cu m (cu ft). Different kinds of brickwork with different mortar shall be taken under separate items. The thickness of wall shall be taken as multiple of half brick as half brick 10 cm, 1 brick 20 cm, 1½ brick 30 cm and so on. The rate shall be for the complete work including scaffolding and all tools and plants.

**Brickwork in arch**—In addition to the above type of arch—rough arch or axed or gauged arch as the case may be, and the centering of the arch should be specified.

#### 8. Brickwork II class and III class—

For II-class brickwork bricks shall be of second class and mortar shall be as specified, may be kankar lime or white lime and surkhi (or sand or cinder) of 1 : 2 to 1 : 3 proportion. Mortar joints shall not exceed 10 mm (½") in thickness. Bricks shall be soaked in water for at least three hours immediately before use. Other details are same as for item 7 above.

For III-class brickwork bricks shall be III class if otherwise not specified. Mortar shall be as specified and mortar joints shall not exceed 12 mm (½") in thickness. Bricks shall be dipped into a tub of water before use.

#### 9. Brickwork in mud mortar—

Bricks shall be specified, may be of II class or III class. The mud should be made of selected earth of tenacious nature so that it sticks and binds bricks. The earth should be soaked in water at least one day before and then worked up with water by labourer treading it, until it is perfectly free from lumps and forms a thick plastic mix. Joints should not exceed (½") 12 mm thickness. Soaking of bricks is not required. The bond of brickwork shall be of English bond. Not more than 60 cm (2') height of brickwork shall be carried out at a time, and the walls must be truly in plumb and every course shall be truly horizontal. Other details of laying, protection, scaffolding and measurement will be similar to item 7 above.

#### 10. Reinforced brickwork (R.B. work)—

**Material**—Bricks shall be strictly of first class quality and selected first class bricks shall be used. Mortar shall consist of cement and coarse sand of 1 : 3 proportion. Cement shall be fresh portland cement. Sand shall be coarse of 5 mm (3/16") size and down and sharp, clean and free from foreign matters. Steel reinforcement shall be of standard specification as described in item 5, page 570.

**Centering and shuttering**—The centering and shuttering shall be made with planking or sheeting of bamboos packed together at the required level supported on runners of beams and covered with a thin layer of about 2.5 cm thick of earth finished off with a light sprinkle of sand. The centering shall be simple in construction so that it could be easily removed without disturbing the structure. The planking shall be kept clear of the bearings for slab and will rest on cross beams only. Planks shall not be laid too close as to tender them liable to jam. Cross beams shall be carried on the walls supported at intervals by ballies or temporary dry brick pillars. The top surface of centering shall be given a camber of 2 mm for every 30 cm of span up to a maximum of 3 mm for slabs and 1.5 mm for every 30 cm of span to maximum of 4 cm for lintels.

**Mixing of mortar**—Mortar of cement and sand shall be mixed thoroughly in the proportion of 1 : 3, first by mixing dry and then adding water slowly and gradually and mixing by turning at least three times to get uniform plastic mix of workable consistency, so that the mortar may be packed round the reinforcement. Quantity of water shall not exceed 25 litres (6.5 gals) per bag of cement. Mortar shall be mixed just before it is actually required and shall be used within 30 minutes. Stale mortar shall never be used.

**Laying**—All bricks shall be thoroughly soaked with water for not less than six hours immediately before use. Bricks shall be laid with frogs downward over the centering in straight line parallel to the direction of the reinforcement bars leaving the required gap for mortar joint. No vertical joint should come along the inner edge of the wall. The gap for mortar joint in which reinforcement has to be placed shall not be less than four times the diameter of bar, so as to provide a cover of 12 mm (½") on all sides of the steel bars. Usually mortar joint shall be 32 mm to 40 mm (1¼" to 1½"). Other joints where there will not be any bar, may be 6 mm to 10 mm (¼" to 3/8") thick. Reinforced brick slab shall have a bearing equal to their thickness with a minimum of 12 cm.

After the bricks have been laid and arranged over the whole area fresh mixed mortar shall be placed into the gaps in between the bricks to a thickness of 2.5 mm (1"). Reinforcing rods previously cut to the correct length and bent and hooked as per design shall be placed exactly at the centre of the joint and pressed down into the mortar to leave 12 mm (½") clear mortar below the bar. The joints shall then be filled in completely with fresh mortar. Newly laid portion shall not be disturbed or walked over. Each slab shall be laid in one operation. Care shall be taken that the reinforcement at all points is completely surrounded on all sides by mortar.

Centering and shuttering shall be removed slowly and carefully without any shock not earlier than 10 days. After removal of the centering if the work is found defective and rods are exposed and visible to sufficient extent the work shall be dismantled and reconstructed. In such a case no extra payment shall be made for reconstruction. If rods are exposed at few places only, they should be covered with rich cement mortar of 1 : 2 proportion by pressing the mortar into the gap immediately after removal of the centering while the laid work is green.

For double layers the upper layer shall be laid with joints of 10 mm (3/8") thickness with 1 : 3 cement and coarse sand mortar immediately after laying the bottom layer. If there are top bars provided in the upper layer, the joints shall be thicker as for bottom layer.

2.5 cm to 4 cm (1" to 1½") thick cement concrete of 1 : 2 : 4 proportion may be provided over the one layer of R.B. work if specified to have greater compressive strength.

**Curing**—Same as for item No. 4, page 570.

**Measurement**—Same as for item No. 5, page 572.

*Finishing*—Plastering of the underside and sides shall be done immediately after opening of the centering with fresh cement and coarse sand mortar of 1 : 3 proportion to a minimum thickness of 12 mm ( $\frac{1}{2}$ " ). Before plastering the surface shall be soaked with water and immediately before plastering is applied the surface shall be given a wash of neat cement with water.

### 11. Plastering cement mortar or lime mortar—

The joints of the brickwork shall be raked out to a depth of 18 mm ( $\frac{3}{4}$ " ) and the surface of the wall shall be washed and kept wet for two days before plastering.

The materials of mortar, cement and sand or lime and surkhi or sand, or kankar lime, as specified should be of standard specifications. The materials of mortar shall be first dry mixed, by measuring with boxes to have the required proportion (as specified), and then water added slowly and gradually and mixed thoroughly.

The thickness of plastering shall be as specified usually 12 mm ( $\frac{1}{2}$ " ) applied in two or three coats. To ensure uniform thickness of plaster, patches of 15 cm  $\times$  15 cm (6" ) strips 1 m (3' ) apart or 10 cm (4" ) wide plaster shall be applied first at about 2 m (6' ) apart to act as a guide. First mortar shall be dashed and pressed over the surface and then brought to a true smooth and uniform surface by means of float and trowel. External plastering shall be started from top and worked down towards floor. Internal plastering shall be started wherever the building frame is ready and centering of the roof slabs have been removed. Ceiling plastering shall be completed before starting of wall plaster. All corners and edges shall be rounded. The plastered surface shall be kept wet for 10 days. The surface should be protected from rain, sun, frost, etc.

For ideal work, the plastering should be applied in three coats—the rendering or first coat of 10 mm, the floating or second coat of 10 mm to 6 mm and finishing coat of 5 to 6 mm, having a total minimum thickness of 20 mm ( $\frac{3}{4}$ " ). The first coat shall be applied on the prepared raked cleaned and wetted surface by dashing the mortar and floated roughly with wooden float. It shall be kept damp for at least two days. When the first coat has sufficiently set, the surface shall be wetted and a second coat of plaster shall be applied and brought to true even surface and then lightly roughened with a wooden float to provide bond for the finished coat. The second coat shall be kept damp for at least two days and then allowed to dry. The finishing coat shall then be applied on the wetted surface of the second coat and finished smooth to true even surface by float and trowel.

The work shall be tested frequently with a straight edge and plumb bob. At the end of the day the plaster shall be left cut clean to line. When the next day's plastering is started the edge of the old work shall be scrapped, cleaned and wetted with cement slurry. At the end of the day the plastering shall be closed on the body of the wall and not nearer than 15 cm to any corner.

Curing shall be started as soon as the plaster has hardened sufficiently not to be damaged when watered. The plaster shall be kept wet for at least 10 days. Any defective plaster shall be cut in rectangular shape and replaced.

If specified, the final surface shall be given special finishing textures, as Scaped textures, Canvas textures, Cork-float finish, Wavy combed finish, Concentric arc finish, etc. with the required tools by engaging an expert worker in the profession.

*Note*—Different proportions of mortar which may be used for plastering—

Cement sand mortar—1 : 3, 1 : 4, 1 : 5, 1 : 6; Cement, lime, sand mortar—1 : 1 : 6; C : L : S

Lime surkhi or sand mortar—1 : 1, 1 : 2; Kankar lime mortar—Kankar lime alone.

For ceiling plastering 1 : 3 cement mortar with coarse sand is generally used.

Cement, lime sand mortar is slow setting and has better workability than cement sand mortar.

For *Water Proof Mud Plaster*, See Chapter 19—Village Housing.

*Measuring*—For measurement, See Chapter 14, *Methods of Measurement*.

### 12. Pointing (cement or lime mortar)—

The joints of the brickwork shall be raked out to a depth of 20 mm ( $\frac{3}{8}$ " ) and the surface of the wall washed and cleaned and kept wet for two days before pointing.

The materials of mortar cement and sand, or lime and surkhi or sand, or kankar lime as specified, shall be of standard specifications. The materials of mortar shall be first dry mixed by measuring with boxes to have the required proportion as specified (1 : 2 or 1 : 3 for cement sand mortar, 1 : 1 for lime surkhi mortar or kankar lime mortar), and then mixed by adding water slowly and gradually and thoroughly mixed.

Mortar shall then be applied in the joints slightly in excess and pressed by a proper tool of the required shape. Extra mortar if any is removed and surface finished. Mortar shall not spread over the face of bricks, and the edges of bricks shall be clearly defined to give a neat appearance. After pointing the surface shall be kept wet for seven days.

*Flush pointing*—The mortar shall be pressed into the raked, cleaned and wet joints and shall be finished off flush and level with edges of brick to give a smooth appearance. The edges shall be neatly trimmed with a trowel and straight edge.

*Ruled pointing*—The mortar shall be pressed into the raked, cleaned and wet joints and a groove of shape and size of 5 to 6 mm deep shall be formed running a forming tool of steel along the centre line of the joint. The vertical joints also shall be finished in a similar way at right angles to the horizontal lines. The finished work shall give a neat and clean appearance with straight edges.

*Weather or Truck pointing*—The mortar shall be applied on the raked, cleaned and wet joints and horizontal joints shall be pressed and finished with a pointing tool so that the joint is sloping from top to bottom. The vertical joint shall be finished as ruled pointing.

*Raised or Trucked pointing*—The mortar shall be applied in raked, cleaned and wet joints in excess to form raised bands. The mortar shall be pressed and run with proper tool to form bands of 6 mm ( $\frac{1}{4}$ " ) raised and 10 mm ( $\frac{3}{8}$ " ) width or as directed.

*Measurement*—For measurement, See Chapter 14, *Methods of Measurement*.

### 13. Lime punning—

White stone lime and shell lime shall be slaked at site of work and mixed in the proportion of 3 of stone lime and one of shell lime and then thoroughly mixed with sufficient quantity of water in a drum. The mixture shall then be screened through a coarse cloth into another container and allowed to settle down for 7 days after which the clear water shall be decanted and the cream like paste of lime shall be taken from top, leaving residue at bottom for application to wall surface. The surface shall be cleaned thoroughly and wetted and the prepared lime paste of proper consistency shall be applied uniformly to 3 mm ( $\frac{1}{8}$ " ) thickness by a wooden trowel. This shall be finished by rubbing with a steel trowel to a hard smooth and shining white surface. After finishing, the surface shall be kept moist for seven days. Lime punning shall be applied on smooth plastered surface when the plaster has hardened.

#### 14. 2.5 cm (1") cement concrete floor—

The cement concrete shall be of proportion 1 : 2 : 4 or 1 : 2½ : 3½ as specified. Cement shall be fresh portland cement of standard specifications. The coarse aggregate shall be hard and tough (granite stone) of 20 mm (¾") gauge, well graded and free from dust, dirt, etc. The sand shall be coarse of 5 mm (3/16") maximum size and down, well graded, clean and free from dust, dirt and organic matters.

The floor shall be levelled and divided into panels of size not exceeding 1 metre in its smaller dimensions and 2 metres in large dimensions. Glass or aluminium strips 3 mm thick and depth equal to the thickness of floor shall be fixed on the base with cement mortar. Required camber of slope shall be given in the floor for draining wash water.

Mixing of concrete shall be done either by hand mixing or by mechanical mixer. In case of hand mixing first cement and sand mixed dry thoroughly and the dry mix of cement and sand mixed with ballast dry till stone ballast are well coated with dry mix of cement and sand and then mixed by adding water slowly and gradually to the required quantity and mixed thoroughly to have uniform plastic mix. The quantity of water shall not exceed 30 litres per bag of cement. Concrete for one panel only shall be mixed in one lot. Alternate panels shall be laid on alternate days. The floor shall be laid in two layers. The lower layer being 22 mm thick and upper layer 3 mm thick. The base shall be made rough and cleaned and soaked with water thoroughly and then given a cement wash just before laying. Concrete shall be placed gently and evenly and compacted by beating with wooden 'thapies' and then the surface shall be tamped with wooden tampers. The surface shall then be smoothed with wooden floats and any unevenness shall be removed by adding 1 : 2 cement sand mortar. Finally the surface shall be finished with wooden or steel floats by applying a thick slurry of mortar. The whole operation of laying shall be completed within 30 minutes. After laying the surface shall be left undisturbed for 2 hours and then covered with wet bags and after 24 hours cured by flooding with water and kept flooded for at least 7 days. The surface of floor may be polished if specified. It is important that same brand of cement is used for the whole floor of one room and the proportions are maintained strictly to have a uniform colour. Junctions of floor with wall plaster, dado and skirting shall be rounded off neatly.

*Coloured floor*—For coloured finish the surface shall be finished with coloured cement or with a mixture of ordinary portland cement and coloured pigment of the desired colour in the proportion of 3 of cement and one of colour (or 4 : 1 or 5 : 1). For coloured floor the thickness of the two layers shall be 19 mm and 6 mm. For polished floor the thickness of surface cement finishing should be 2.5 mm to allow for grinding and polishing.

*Base*—In ground floor the c.c. floor is to be laid on a 7.5 cm (3") base of lime concrete or weak cement concrete as per standard specifications. If the bases consist of cement concrete it shall be allowed to set for about 7 days. In case the base is of weak cement concrete the flooring shall commence within 48 hours of laying the base.

In first floor or upper floor if c.c. floor is to be laid on R.C.C. slab, the surface of R.C.C. slab shall be made rough with brushes while concrete is green. Before laying the c.c. floor the surface shall be cleaned, wetted and a neat cement wash shall be applied to get a good bond. A base of lime concrete may also be provided over the R.C.C. slab if specified. The base shall be provided with the slope required for the flooring.

*The thickness of c.c. floor for office building, school building, and in upper floor should be 4 cm (1½").*

*Patent stone floor*—This is cement concrete floor but furnace slag of 10 mm gauge is used instead of stone grit. In other respects, same specifications as for cement concrete floor (above) may be followed.

#### 15. Mosaic or terrazo floor—

The mosaic floor consists of two layers, the bottom layer 2 cm to 2.5 cm (¾" to 1") cement concrete, 1:2:4 (or 1:2½:3½, as specified), and the upper layer 6 mm (¼") thick consisting of a mix of marble chips and cement in the proportion of 1:1½, one part of cement and 1½ parts of marble chips. The top layer is laid on the following day. It shall be laid more than the specified thickness in order to get the specified thickness after cutting and finishing. Cement shall be of standard specifications. The sand shall be coarse, well graded, clean and free from dust and dirt. The stone grit shall be hard and tough (granite stone) of 12 mm (½") gauge well graded, clean and free from dust and dirt. The marble chips shall be of 3 mm (1/8") gauge having maximum size 3 mm (1/8") and minimum size of 1.5 mm (1/16"). Large size of marble chips limited to 6 mm (¼") may be used in floors of big rooms.

Cement concrete shall be prepared by mixing the ingredients dry by measuring with boxes to have the required proportion. First cement and sand shall be mixed dry and this dry mix shall be mixed with stone chips dry and then mixed by adding water slowly and gradually and mixed thoroughly to have a uniform plastic mix. The base shall be made rough and watered and given a cement wash, and then the concrete shall be laid in 2 cm (¾") thick layer in panels of 1 m × 2 m (3' × 6') bounded by 3 mm thick glass or aluminium strips. After laying, the concrete shall be compacted by beating and tamping and levelled with wooden floats.

The marble chips and cement shall be mixed by measuring with boxes to have the required proportion first dry mixed, and then thoroughly mixed by adding water gradually to have a uniform plastic mix. Within two hours of laying of the bottom layer of cement concrete, the upper layer of marble chips and cement shall be laid, and the surface tamped lightly and finished perfectly level with straight edge float and trowel. After about 2 hours of laying, the surface shall be covered with wet bags and kept wet and left undisturbed for two days. The surface shall then be cut or ground by rubbing with sand stone blocks and all the cement in the surface removed. A neat cement wash shall then be given in the surface and left undisturbed for six days and then the surface shall be ground (or rubbed) with corborundum stones of different grades starting with coarse one and successively with finer ones, and the rubbing continued until the entire surface shows a uniform granular appearance. The surface should be kept wet during all these days. After final rubbing the surface shall be thoroughly cleaned by washing with soap water and then with clean water.

Finally when the surface is absolutely dry, oxalic acid powder shall be well rubbed on the surface with pieces of felt and a few drops of water and this operation shall be repeated until the surface becomes perfectly smooth and glossy. The surface may also be rubbed with wax to give a glazing surface. White cement or coloured cement shall be used to have the required colour if specified.

(Proportion of mosaic layer may be 1 : 2 or 1 : 1½ or 1 : 1 cement, marble chips as specified. The mosaic layer may also be applied on the following day instead of the same day of concreting, if specified. In that case surface should be left rough and a neat cement wash shall be applied just before mosaic layer is laid.)

For ground floor a base of L.C. or weak c.c. and for first and upper floor roughening and cement washing shall be provided as described under item 14.

The grinding and polishing may also be done by grinding machines in three operations, first grinding with machine fitted with coarse grade stone, second grinding with medium grade stone, and final grinding with fine grade stone.

**Mosaic or terrazo tile floor**—Precast manufactured mosaic or terrazo tiles are used. For details see page 507. The method of grinding and polishing are same as for mosaic or terrazo floor above (item 16).

**16. Brick-on-edge or brick flooring over 7.5 cm (3") lime concrete—**

The bricks shall be first class selected to have smooth face, good red colour and hardness. The mortar shall be specified (1 : 6 cement sand mortar, or 1 : 2 lime surkhi mortar or kankar lime mortar). All bricks shall be soaked in water in a tank for at least 12 hours before use. Lime concrete of base shall be of the same specification as for item 2. The surface of base lime concrete shall be cambered or sloped for draining wash water as per drawing or instructions. The bricks shall be laid with mortar as specified with break joints at half the length of brick, with the required bond. The surface should be checked frequently with spirit level and wooden straight edge to have a true surface. No damaged or broken bricks shall be used anywhere except at the edges, where properly straight cut bricks shall be used. Mortar joints shall not exceed 12 mm ( $\frac{1}{2}$ ") and all joints should be full of mortar. The brick work should not be disturbed but shall be kept wet for at least 10 days. The surface should be finished with pointing with cement mortar as specified.

**17. White washing—**

Fresh white lime slacked at site of work should be mixed with sufficient water to make a thin cream. The approximate quantity of water required in making the cream is 5 litres of water to 1 kg of lime. It shall then be screened through a coarse cloth and gum (glue) in the proportion of 100 grams of gum to 16 litres (three chatacks of gum to 6 gallons) of wash shall be added. The surface should be dry and thoroughly cleaned from dust and dirt. The wash shall be applied with 'moon' or jute brush, vertically and horizontally alternately and the wash kept stirred in the container while using. Two or three coats shall be applied as specified and each coat shall be perfectly dry before the succeeding coat is applied over it. After finishing the surface shall be of uniform colour. The white wash should not splash on the floor and other surfaces. In old surface the surface should be cleaned and repaired with cement mortar where necessary and allowed to dry before white wash is applied. For final coat blue pigment powder should be mixed to the required quantity with the lime water to give a bright white surface.

**18. Colour washing—**

Colour wash shall be prepared with fresh slaked white lime mixed with water to make thin cream adding the coloured pigment to the required quantity to give the required tint. Gum (glue) in the proportion of 100 gm of gum to 16 litres (three chatacks of gum to six gallons) of wash shall be added. The colour wash may be applied one or two coats as specified. The method of application should be same as for white washing (item 17). For new work the priming coat shall be of white wash.

**19. Distemping—**

The distemper shall be of best quality and the colour should be as specified. The distemper should be mixed and prepared and water added, as laid down in the instructions of the manufacturer. First a paste is made by adding little hot water to the distemper powder and stirred thoroughly, and the paste is allowed to stand for a few minutes. The paste is then thinned with water to have a thin cream to the consistency of oil paint and stirred thoroughly all the time while applying. If the surface is rough, it should be smoothed with sand paper.

The surface must be perfectly dry before distemping is commenced. In new cement plaster the surface shall be washed over with a solution of zinc sulphate, one kg zinc sulphate in 10 litres of water and then allowed to dry. In old surface, the surface shall be repaired with plaster

of paris where required and then whole surface sand papered and washed and allowed to dry.

The number of coats shall be two or as specified. The distemper shall be kept well stirred in containers and shall be applied with broad brushes first horizontally and immediately crossed vertically. Brushing should not be continued too long to avoid brush marks. The second coat shall be applied after the first coat is dried up. After each day's work the brushes shall be washed and kept dry. Distemping should be done during dry weather but not during too hot weather, nor wet weather.

**Oil distemper**—Oil distemper is similar to ordinary dry distemper in powder form. In the oil distemper compound (dry powder) oil is mixed by the manufacturer while manufacturing. For application of oil distemper it is mixed with the required quantity of water and then applied on the surface. The methods of preparation and application are similar as described above.

**20. Snowcem washing—**

**General**—Snowcem consists of a base of white cement mixed with finely powdered colouring pigment to have the desired colour and with the addition of small quantities of other ingredients. It gives a water proof surface. Snowcem is sold by the manufacturer in 50 kg drums, 25 kg drums and 5 kg tin of various colours. The snowcem of the desired colour may be chosen.

**Mixing**—Only fresh snowcem should be used. Hard or set snowcem should not be used. The contents should be made loose by rolling and shaking the container before opening the container. First a paste shall be prepared by mixing 2 parts of snowcem powder with one part of water by volume and immediately this should be thinned by adding another one part of water to have a uniform solution of consistency of paints.

[Mix 1 litre (2 pints) of water with 3 kg (7 lbs) of snowcem powder to get a paste, dilute this with another 1 litre (2 pints) of water which will give approximately 3 litres (6 pints) of snowcem for application.]

**Application**—The surface should be cleaned to remove loose dust or dirt by use of a soft wire brush. The surface shall then be wetted by sprinkling with water and water shall be allowed to run off. The fresh mixed snowcem shall then be applied with broad good quality brush. The first coat shall be well brushed into the surface to form a good bond. Snowcem should be used within an hour of mixing and should be kept stirred during application. At the end of the day each application of snowcem the surface should be wetted with fine water spray for curing.

After a day or two a second coat of snowcem of similar preparation should be applied on the wetted surface and the second coat should be applied carefully to give a uniform and good finished appearance.

The approximate covering capacity of 50 kg of snowcem for two coats on plastered surface is 100 sq m (1000 sq ft).

Other cement washing compound as Supercem, Aquacem, Durocem, etc., may also be used similar to Snowcem.

**21. Decorative cement colour washing (similar to snowcem)—**

For decorative as well as water repellent washing on the external surface of buildings, white cement mixed with colour (pigment) and other ingredients may be used. The quantities

(proportion) of the different ingredients in percentage basis as well as per bag of cement are given below) :—

Ingredients	Percentage by weight	Per bag of cement
(1) White cement	75%	50 kg
(2) Slaked lime (clean, screened)	10%	6.5 kg
(3) Powdered glue	10%	6.5 kg
(4) Alum	2%	1.3 kg
(5) Aluminium Stearate	1/2%	0.33 kg
(6) Plaster of Paris	2 1/2%	1.63 kg

To get the desired colour and shade, powdered metallic colour should be mixed with white cement to the extent of 5% to 10% of the white cement by weight (2.5 kg to 5 kg per bag of cement).

**Mixing and preparation**—Slaked lime should be dissolved in cold water and powdered glue and powdered alum should be dissolved in hot water in separate containers or drums. The solution should be thin and should be screened through a piece of cloth, and prepared and kept ready in advance of application.

At the time of application White cement, Plaster of Paris, Aluminium stearate and colour should be mixed intimately in the above mentioned proportions and the mixture added to the slaked lime solution and stirred continuously. The alum and glue solutions should then be added and stirring continued. Fresh water should then be added to bring the solution to the consistency of a cream similar to oil paint. The final mixed solution should consist of all the ingredients in the proportion mentioned above. The mixing should be by batches of about 1/4 bag of cement at a time with other ingredients in the same proportion. A uniform consistency should be maintained for all batches of mix. Only as much quantity as can be used within half an hour should be prepared and mixed at a time.

**Application of wash**—Before the wash is applied, the surface should be rubbed and cleaned of all loose dust and dirt, and washed with water and wetted. The mixed cement wash should then be applied evenly with broad distemper brushes. Second coat should be applied after 4 hours and during this period the surface should be kept moist.

**Curing**—After application of the cement the surface should be kept moist for at least two days by frequent light sprinkling of water. Surface should be protected from hot sun and drying winds by hangingessian cloth on the scaffolding and periodically wetting it with water.

**Covering capacity**—One bag of white cement (50 kg) mixed with other ingredients will cover an area of 80 sq m to 100 sq m (800 sq ft to 1000 sq ft) for two coats over plastered surface.

One expert washer (white washer) and one boy coolie can wash 30 sq m to 40 sq m (300 sq ft to 400 sq ft) per day for first coat, and 40 sq m to 50 sq m (400 sq ft to 500 sq ft) per day for second coat.

## 22. Painting—

The brand of the paint shall be specified and ready-made paint of the required colour should be used. If thinning is required, pure turpentine may be added to the required extent. The surface shall be made perfectly smooth by rubbing with sand paper of different grades, first with coarse one and successively with fine sand papers. All holes and open joints should be filled with strong putty or with a mixture of glue and plaster of Paris and smoothed by rubbing with sand paper. In steel

work, all rusts and scales shall be perfectly removed by scrapping and brushing.

The number of coats shall be as specified in new work one priming coat and then two coats of paints shall be applied. The paint shall be applied with brushes evenly and smoothly by crossing and laying of in the direction of grains of wood-work and no brush marks should be visible. Each coat shall be perfectly dry before the next is applied. Before the next coat is applied, the surface shall be rubbed with No. 0 sand paper, to give a smooth and glazed surface. The paint should be stirred in the container immediately before use. Brushes should be cleaned and washed with turpentine at the end of the day's work and kept dry.

If stiff paint is used it should be first prepared by mixing with double boiled linseed oil and turpentine to a thin cream.

For measurement of painting on different works, Chapter 14 on Methods of Measurement may be referred.

If old paint is to be removed, it may be removed by washing with soda water or with caustic soda or blowing with blow lamp and scrapping or by using any patent remover. After removing the paint the surface should be dried and rubbed with sand paper and smoothed before paint is applied. In old painted surface if paint is not required to be removed but required repainting, the surface should be washed with soap water and then paint shall be applied.

In steel work exposed to weather, the painting should be done either with red oxide paint or with aluminium paint.

## 23. Painting steel and iron work—

All rust scales, dirt, suppliers delivery marks, oil, grease, etc., shall be removed by rubbing with sand paper before painting. Special care shall be taken for cleaning of corners. All structural steel work shall be painted with red lead before erection except the surfaces which will be in contact with concrete. Where corrosive effect is likelihood from sea atmosphere, a coat of raw lined oil shall be applied on the surface immediately after cleaning and before the 1st coat of red lead is applied. Two to three coats of approved ready-manufactured paint or ready-mixed paint shall be applied at right angles to each other after erection of the structural member. Each coat shall be allowed to dry up perfectly before the succeeding coat is laid over it. Painting shall be carried out during the dry weather.

## 24. Varnishing—

Knots, holes, cracks, etc., shall be filled and covered with putty made of whiting and lined oil. The wood work shall be rubbed down with sand paper sufficiently smooth to remove any grain marks and it shall be cleaned before-hand. Two coats of boiled linseed oil or two thin coat of glue as specified shall be applied and each such coat shall be allowed to dry up and rubbed down smooth with a fine sand paper. The varnish shall be applied with brushes using strong firm strokes, of brushes and spread evenly. The brushes shall be of good quality and perfectly cleaned. In no case sand paper shall be rubbed across the grain, which may cause the finest marks on the finished surface. Specified quality of copal varnish shall then be laid on the prepared surface in thin coats unless any other brand is specially mentioned. For new wood work a second coat shall be applied after the first coat of varnish has thoroughly been dried up. Varnishing shall be done during dry weather and should not be allowed to be undertaken in rainy days.

## 25. French spirit polishing—

**Polish**—Pure shellac varying from pale orange to lemon yellow colour, free from resin, dirt, etc., shall be dissolved in methylated spirit at the rate of 0.15 kg of shellac to 1 litre of spirit. Suitable pigment shall be added to get the required shade.



*Preparation of surface.*—The surface of the timber shall be cleaned and rubbed down smooth with sand paper. Knots if visible shall be covered with a preparation of lead and glue laid on while hot. Holes and indentations on the surface shall be filled with putty and smoothed. The surface shall then be given a coat of wood filler made by mixing whiting (powdered chalk) in methylated spirit at the rate of 1.5 kg of whiting per litre of spirit. The surface shall then be rubbed down perfectly smooth with glass paper and wiped clean.

*Application.*—A pad of woolen cloth covered by a fine cloth shall be used to apply the polish. The pad shall be moistened with the polish and rubbed hard on the wood, in series of overlapping circles applying the polish sparingly but uniformly over the entire surface to give a uniform surface and high gloss. Number of coat shall be as specified. The second coat shall be applied, after the first is dried, in the same way as for the first coat.

#### 26. Wood work (carpenter's work)—

All wood work of which the scantling exceeds 20 sq cm (3 sq in) section and which is not specially moulded or carved comes under carpenter's work. This include all timber work in chauhats of doors and windows, in roof works as beams, struts, ties, rafters purlins in timber bridge, etc.

Timber shall be as specified, may be teak, shisham, sal, deodar, etc. The timber shall be of the best quality well seasoned and free from saps, knots, warps, crack and other defects. The scantling shall be sawn in the direction of the grains. All wood work shall be planed and neatly and truly finished to the exact dimensions. All joints shall be neat and strong, truly and accurately fitted, and coated with white lead before being fitted together.

All portions of timber built into or in contact of masonry or concrete shall be given two coats of solignum or tar or other approved preservations. Exposed surfaces of timber shall be painted with two coats of approved paint over a coat of priming.

All beams shall be bedded on plates with a minimum bearing of 25 cm and 6 mm clear air spaces shall be left on each side. No wood work shall be fixed within 60 cm of any fire place or flue.

Measurement of wood work shall be taken in cu m (cu ft) for the finished work fixed in position including sawing, planing, joining, nails, screws, etc. Painting of wood work shall be measured under separate item.

#### 27. Doors and windows—

Timber shall be of the kind as specified, may be teak, shisham, sal, deodar, etc. The timber shall be of the best quality, well seasoned and free from sap, knots, warps, cracks, and other defects. All wood work shall be planed, and neatly and truly finished to the exact dimensions. All joints shall be neat and strong, truly and accurately fitted, and glued before being fitted together.

*Chauhats.*—The chauhats shall be properly framed and joined by mortise and tenon joint with hard wooden pins, and the joints shall be coated with white lead before being fitted together. The chauhats shall be of section as per drawing, may be 7.5×10 cm, 10×10 cm, 8×12 cm or similar section. For double leaves the chauhats shall be of 8×12 cm section. Concealed faces of chauhats shall be painted with two coats of coaltar or solignum and the other faces shall be painted with a prime coat before fixing in position.

*Shutters or leaves (Joinery).*—The shutters may be panelled, glazed, part panelled and part glazed battened, or venetian as specified. The thickness of shutters shall be (1½" to 2") 3 cm to 5 cm as specified. The styles, rails and panels shall be planed and neatly and truly finished to the exact dimensions. The styles and rails shall be framed properly and accurately with mortices and tenon

joint and fixed with wooden pins. Panels shall be of one piece without any joint and shall be fixed with 12 mm (½") insertions into the rails and styles and rails provided with mouldings as per design.

The thickness of panels shall be 12 mm to 25 mm (½" to 1") as specified. All rail over 15 cm (6") in width shall have double tenon. No tenon shall exceed one-fourth of thickness of the plank. For glazed windows sash bars shall not be less than 40 mm × 40 mm and glasses shall be fixed with nails and putty or with wooden beadings over felt as specified. All joints shall be glued before being fitted. (For joints see pages 519-520).

*Fittings.*—All doors shall be provided with handles on both sides and all windows with handles on the inner side. One of the doors of each room shall be provided with sliding bolts on the outer side for locking. Necessary hinges, tower bolts, hook bolts, stops for keeping the leaves open, and also wooden blocks to prevent leaves striking the jambs of wall, etc., shall be provided. The fittings may be of iron, brass or oxidized as specified of approved quality. Screws shall be of suitable length and correct diameter and shall be fixed with screw driver and not by hammering.

*Painting.*—The surface of shutters and chauhats shall be painted with two coats of approved paint over a coat of priming. Faces of chauhats in contact with masonry shall be painted with two coats of solignum or coaltar or other preservative before fixing. A prime coat of painting with primer paint shall be applied on the remaining surface before fixing in position.

*Measurement.*—The rate shall be for the complete work including hanging and fixing in position. The chauhats shall be measured in cu m (cu ft) under wood work for the finished work, and the length of tenons, horns, etc., shall be added to right lengths. The measurement of shutters shall be taken in sq m (sq ft) for the finished work in closed position overlaps of two shutters shall not be measured. The painting shall be measured separately under a separate item in sq m (sq ft). The cost of fittings may be excluded if specified, and the fittings supplied by the department or owner, but the fixing of the fittings and hanging in position shall be included in the rate. (For measurement refer Chapter 14—Methods of Measurement.)

#### 28. Glazing—

Glass shall be of the best quality and free from bubbles, scratches and other imperfections. The thickness of glass be 3 mm or as specified. The glass panes shall be fixed in 15 mm rebate of the wooden frame leaving 1.5 mm clear gap allround for allowing for expansions. The rebate shall be painted before glasses are fixed. Putty shall be of best quality made of finely powdered whiting and linseed oil, kneaded into a stiff paste. First a thin layer of putty (back putty) shall be applied on the rebate, then glass shall be fixed in position by a few small nails and then putty (front putty) shall be applied and pressed in position and finished off neatly and in such a manner that no putty projects beyond the rebate. The putty shall then be painted with a coat of paint.

In case of large glass panes or plate glasses, these should be fixed in the rebate by moulded wooden fillets allround with brass or nickle screws, inserting a strip of felt or rubber in the rebate under the glass to act as a cushion. The wooden fillets shall be finished with painting.

#### 29. Centering and shuttering

Shuttering shall be either of hard wooden planking 30 mm (1½") thick (or of steel plates stiffened by angle iron). The shuttering shall be supported on battens, beams, props and wedges and properly cross braced together so as to make the form work sufficiently rigid strong and stable to support the wet concrete work and should not yield on working and laying concrete. Beams for centering shall be carried and supported on the walls with double wedges underneath and supported at intervals with props.

Props shall consist of ballies or brick pillars in mud mortar. Ballie props shall rest on double wedges placed over wooden sole planks of 40 mm (1½") thickness so as to facilitate tightening and easing of the centering and shuttering. In case of brick pillars the wooden sole plank shall be provided at the top of pillars and double wedges inserted in between the sole plank and the beam of the centering and shuttering.

The shuttering shall be kept clear of wall bearing and made to rest on cross-beams or battens. The shuttering shall have smooth and even surface and its joints shall be closed tight and shall not permit leakage of cement mortar, if required the joints shall be lined with craft paper or other approved material. Inner face of shuttering shall be applied with a wash of moulded oil or raw linned oil or soap solution or other approved materials to prevent adherence of the concrete.

For slabs and beams small camber shall be given in the shuttering. Camber of 1 cm per 2.50 m or ½" per 10 ft (1 in 1250) with a maximum 4 cm (1½").

Centering and shuttering shall not be removed before 14 days in general (4 days for R.C.C. columns, 10 days for roof slab and 14 days for beams).

Centering and shuttering shall be removed slowly and carefully without any shock or vibration by slackening and removing the wedges gradually in such a manner that no part of the concrete is disturbed or damaged.

Centering and shuttering shall be measured in sq m, and the surface area in contact with concrete shall be measured.

#### 30. Ashlar masonry—

The stone shall be hard, tough, round and durable of approved quarry. Stones shall be chisel dressed on all beds (all sides) to have perfectly square or rectangular faces so that they may be laid in perfectly horizontal and vertical joints. Minimum height of stone shall be 20 cm (8") and breadth not less than 1½ times height. Stone shall be laid alternate headers and stretchers with break joint and proper bond shall be maintained not to have any vertical joint in two consecutive layers. Each course shall be truly horizontal and each stone shall be laid on its natural bed. The wall shall be truly in plumb. No joint shall be thicker than 3.5 mm (1/8"). If pointing is not provided as separate item, the joints shall be struck and finished at the time of laying. Not more than 60 cm (2') height of masonry shall be constructed at a time.

Mortar shall be as specified, rich fine mortar shall be used, may be of cement mortar 1 : 2 to 1 : 4 or lime mortar 1 : 1 to 1 : 2, materials of mortar shall be of standard specifications. Mortar shall be first dry mixed to have the required proportion and then mixed with water by adding water slowly and gradually and mixed thoroughly to get a uniform mortar of workable consistency. Fresh mixed mortar shall be used.

All stones shall be thoroughly wetted before use. At the end of day's work the masonry shall be flooded with 2.5 cm (1") water at the upper surfaces. The masonry shall be kept moist for a period of at least 10 days and shall be protected from sun, rain, frost and other weather effect.

Usually, exposed faces of stones and edges of face stones fine chisel dressed and inner surfaces of stones are rough chiseled. In such case the inner joint may be 6 mm (¼") thick.

#### 31. Coursed rubble stone masonry—

The stone shall be hard, sound and durable of approved quarry. Stones shall be hammer dressed on bed and top and also on sides so that the stones will come to close proximity and each stone can be laid in course. Stone with round surface shall not be used. Each course shall consist of

stone not less than 10 cm (6") thick. Stone should be laid with broader face downward and vertical joints should be broken. All courses shall be truly horizontal and all joints shall be full of mortar. Outer faces of stones shall be squared by hammer dressing to give a good appearance, and faces of wall shall be truly in plumb. The face joints shall be at right angle to the face for at least to a depth of 5 cm (2"). The face stones shall be laid alternate headers and stretchers and should tail into wall to sufficient depth to bond well. Corner stones or quoins should be of good stone and dressed to correct angle and laid header and stretcher alternately.

Mortar shall be as specified, may be cement mortar 1 : 3 to 1 : 6 or lime mortar 1 : 2 to 1 : 3. Materials of mortar shall be of standard specifications. Mortar shall be first dry mixed to have the required proportion and then mixed with water by adding water slowly and gradually and mixed thoroughly to get a uniform mortar of workable consistency. Fresh mixed mortar shall be used. Joints shall not be thicker than 12 mm (½"), face joints shall be thinner. Interstices, if any, may be filled with pieces of spalls of stones embedded in mortar. Not more than 60 cm (2 feet) height of masonry shall be constructed at a time.

Through bond stones of one piece shall be provided one for every 0.5 sq m (5 sq ft) of face and should extend to the full thickness of walls. For walls thicker than 75 cm (2½") the bond stones may be of two pieces placed with side overlapping of at least 15 cm (6 inches). Breadth of bond stones shall not be less than 1½ times the height.

All stones shall be thoroughly wetted before laying. At the end of day's work the masonry shall be flooded with 2.5 cm (1") water at the upper surface. The masonry shall be kept moist for a period of at least 10 days and shall be protected from sun, rain, frost and other weather effect.

#### 32. Random rubble stone masonry—

The stone shall be hard, sound and durable of approved quarry. Stone shall be hammer dressed to secure close joint so that the stones when laid will come into close proximity. Stones shall be fairly equal in size and every stone shall be fitted to the adjacent stones. No stone shall be less than 15 cm (6") in size. Stone with round surface shall not be used.

Face stone shall be comparatively larger and uniform in size and colour to give a good appearance and breadth of face stones shall be greater than the height. Face stone should tail into wall to a sufficient depth to bond well. Stones shall be laid with broader face downward to give a good bedding. Face joints shall be broken and face of wall shall be truly in plumb. Corner stones or quoins should be a good stone and dressed to correct angle and laid as headers and stretchers.

Mortar shall be as specified, may be of cement mortar 1 : 3 to 1 : 6 or lime mortar 1 : 2 to 1 : 3. Materials of mortar shall be of standard specifications. Mortar shall be first dry mixed to have the required proportion and then mixed with water by adding water slowly and gradually and mixed thoroughly to get a uniform mortar of workable consistency. Fresh mixed mortar shall be used. Joints shall not be thicker than 2 cm (¾"), face joints shall be thinner. Interstices, if any, may be filled with pieces or spalls of stones embedded in mortar. Not more than 60 cm (2') height of masonry shall be constructed at a time.

Through bond stones of one piece shall be provided one for every 0.5 sq m (5 sq ft) of face and should extend to the full thickness of wall. For wall thicker than 75 cm (2½") bond stones may be of two pieces placed side by side overlapping at least 15 cm (6"). Breadth of bond stones shall not be less than 1½ times the height.

All stones shall be thoroughly wetted before laying. At the end of day's work the masonry shall be flooded with 2.5 cm (1") water at the upper surface. The masonry shall be kept moist for a period of at least 10 days and shall be protected from sun, rain, frost and other weather effect.

### 33. Mud phuska terracing with tile brick paving—

Mud phuska terracing will be suitable in hot dry regions where the rainfall does not exceed 130 cm per annum and extremely hot temperature occurs during summer.

**Mud mortar.**—Mud mortar shall be prepared from good brick-earth free from grass, root, gravel, kankar, etc. The earth shall be reduced to a fine powdered state and mixed with 'bhusa' at 8 kg per cu m of mortar (12 lbs per 4 cu ft) and then mixed with sufficient water in a pit. The mix shall be worked up with spades (phawras) and feet daily for at least 4 days so as to get a homogeneous mass.

**Laying.**—The mud mortar shall be laid on the terrace to the requisite thickness 7.5 cm to 10 cm (3" to 4") and a minimum slope of 1 in 48 towards the outlets, and rammed with wooden thapis under optimum moisture condition. The surface shall be checked with straight edge and spirit level and corrected where necessary, with the same mortar. The surface shall be allowed to dry somewhat and if any cracks appear these shall be filled with liquid cowdung.

**Mud gobi plaster.**—The surface shall then be given a coat of 12 mm (½") plaster of mud gobi mortar 3 : 1 (3 mud : 1 cowdung). Cowdung free from grass, straw seeds and other impurities shall be soaked in water and powdered earth shall be added in the ratio of 3 : 1, and mixed thoroughly adding water to have homogeneous mix of the workable consistency. The mortar shall then be applied to a uniform thickness of 12 mm (½").

**Paving with the brick.**—First class flat tiles 4 cm (1½") thick well burnt made of good brick-earth shall be used. The tiles shall be laid dry on the mud gobi plaster before it dries up completely (not over cement or lime mortar) with open joints not more than 6 mm (¼") wide. Tiles should be inserted into parapet walls by 4 cm (1½"). The open joints shall then be grouted with cement mortar 1 : 3 (1 cement, 3 local sand) care should be taken to see that no joint remains unfilled or partially filled. The joints shall then be finished flush with the surface. The tile paving shall be cured by covering with wet bags or wet sand (not by ponding) for at least seven days and during this period the surface shall be protected from damage.

**Measurement.**—The rate shall be for the complete work of mud layer of the stipulated thickness, mud gobi plaster and the tile paving. The measurement shall be taken for the finished work over the tiled surface in sq m (sq ft). No deduction shall be made for opening or recesses up to 0.4 sq m (4 sq ft).

Mud terracing may be over R.C.C. slab, or two layers of tiles or one layer of brick or one layer of stone slab or wooden planks supported on batten or beams of R.C.C. steel or timber.

One coat or two coats of asphalt may be applied on the base slab or concrete before laying the mud mortar if specified.

### 34. Madras terrace roof—

Madras terrace roof shall consist of a layer of a lime concrete over a layer of brick-on-edge laid in lime mortar, supported over beams or battens. (See Fig. 4-4, page 187).

**Terrace brickwork.**—The terrace brick shall be of first class quality of 15×7.5×2.5 cm in size and shall be laid on-edge in diagonal rows with lime surkhi mortar of 1 : 1½ proportion, closely packed spanning over the beams. The brickwork shall be so laid as to have slight camber not

exceeding 5 cm in between the joints, to enhance the self-supporting arch action. The spacing of the beams or battens shall not be more than 45 cm. The brickwork shall then be cured by frequent sprinkling of water for a period of 10 days. After setting of the brickwork a layer of lime concrete shall be laid.

Before brickwork is laid centering and shuttering shall be made strong and rigid enough to support the roof during construction.

**Brick aggregate.**—The brick aggregate shall be well burnt of first class quality and broken to 20 mm (¾") size and shall contain 5 to 10 per cent surkhi. The grading of brick aggregate shall be as—

100 per cent passing through IS—sieve of 20 mm and 5 to 100 per cent passing through IS—sieve of 10 mm.

**Mixing and laying of Lime Concrete (Lime-Brick-Jelly Concrete).**—Brick aggregate shall be cleaned and placed on a water tight platform and spread to an even thickness and thoroughly wetted for at least three hours. Fresh slaked white lime shall then be spread over the brick aggregate stack to have the proportion of 1 : 2½ (one of lime and 2½ of aggregate) and mixed dry. The whole is then mixed by adding water gradually by sprinkling to the required quantity, and mixed thoroughly by turning at least three times, until a uniform mix is obtained and all pieces of aggregates are covered with mortar and the aggregates do not separate from the mortar.

The brickwork shall then be lightly sprinkled with water just to moisten the surface and then the mixed lime concrete shall be laid gently to a thickness of 10 cm. The roof shall be given a minimum slope of 1 in 50.

After the lime concrete has been laid, it shall be consolidated initially with wooden rammers of 2 kg weight, and the consolidation shall further be done with hand beaters so that the concrete hardens and the surface becomes even during consolidation and beating solution of Bael fruit, molasses and lime water or solution of Kadukai, molasses and lime water shall be sprinkled over the surface for strengthening and water proofing. (For details see lime concrete terracing page 567). The bearing shall be continued until the beater makes no impression on the concrete, and readily rebounds from the surface when struck on it. After compaction the surface shall be wetted with solution of Bael fruit or Kadukai, molasses or lime and smoothed with trowel to have a thin water proof layer.

**Curing.**—The lime concrete shall be kept moist for a fortnight by covering with straw or sand and sprinkling water frequently.

The ceiling shall be finished with 12 mm (½") plastering with 1 : 3 cement mortar or 1 : 2 lime mortar.

**Measurement.**—The lime concrete terracing including brickwork shall be measured of the finished surface under one item in sq m (sq ft). The supporting beams or battens and ceiling plastering shall be measured separately.

### 35. Asbestos cement corrugated sheet roofing—

**Sheets.**—The sheets shall be of the best quality of approved manufacturers as 'Everest', 'Bigsix', 'Crownit corrugated', 'Ashoka corrugated' or similar. The sheets shall be free from cracks, chipped edges or corners and other damages.

**Purlins.**—The sheets shall be laid on wooden or steel purlins as per drawing. The maximum spacing of purlins shall be 1.6 m (5'-3") in the case of 7 mm (9/32") thick sheet and 1.4 m (4'-6") in the case of 6 mm (¼") thick sheets. The upper surfaces of purlins shall be in one plan so that the sheets shall rest on the purlins without forcing down.

**Laying.**—The sheets shall be laid with smooth side upwards, with a minimum side lap of half a corrugated 4.5 cm (1½") and a minimum end lap of 15 cm (6"). The side laps shall be laid on the side opposite the prevailing monsoon wind. The free overhang of the sheet shall not exceed 40 cm (1'-4").

**Fixing.**—The sheets shall be fixed to the purlins by means of 8 mm (3/16") diameter galvanized J or L hook bolts and nuts providing a bitumen washer and a galvanized iron washer for each bolt and nut before the nut is screwed down from above. Each nut shall be screwed lightly first and when a number of sheets are laid the nuts shall be tightened. The holes for hook bolt shall be drilled not punched in the ridge of the corrugations in their exact positions while the sheets are on the roof. The diameter of the holes shall be 1.5 mm (1/16") more than the diameter of the fixing bolt. Roof ladders or planks shall always be used when laying and fixing the sheets, to avoid damage to the sheets. During fixing if any sheet gets damaged this shall be rejected and replaced by another good sheet. The finished surface shall be uniform and the lines of corrugations shall be straight and parallel.

**Slope.**—Roof slope shall not be flatter than 1 in 5, the normal slope shall be usually 1 in 2. In case of roof slope flatter than 1 in 2½, the end overlap shall be 25 cm (10") or more.

**Ridges.**—Ridges shall be of the type specified such as "Plain wing adjustable", "Serrated adjustable", "Close fitting adjustable", "Northlight adjustable", etc. Ridges shall be of the same manufacturer as for the corrugated sheets, and shall be free from cracks and damages. The ridges are usually in pairs having the required overlap. The ridges shall be fixed with the same galvanized iron J or L bolts and nuts with bitumen washer and galvanized iron washer which fix the sheets with purlins.

Hips if required shall be of "Unserrated hips" of the same manufacturer.

**Wind ties.**—Wind ties shall be of 40 mm x 6 mm (1½" x ¼") and shall be fixed at the eave ends of the sheets. The fixing shall be done with the same hook bolts which secure the sheets to the purlins.

**Measurement.**—The measurements shall be taken of the laid finished flat surface in sq m (sq ft) and not girted. The laps at the ends and side shall not be measured. The ridges and hips shall be measured in running metre (r ft) for the finished work along the centre line of the ridge or hip. Wind ties shall be measured under a separate item. The rate shall include all the materials and labour, bolts and nuts washer, etc. The rate shall not include roof supporting members as purlins, rafters, etc., which shall be measured separately.

### 36. Asbestos cement semi-corrugated or trafford sheet roofing—

The detailed specifications shall be similar to the above with the exceptions that the side overlap shall be one corrugation 9 cm.

### 37. Galvanized corrugated iron sheet (G.C.I. sheet) roofing—

The corrugated iron shall be of the gauge as specified, 22 B. G. (8 mm thick) or 34 B. G. (.64 mm thick). The sheets shall be free from rust and the zinc covering at the time of fixing shall be in perfect condition.

The sheet shall be laid on wooden or steel purlins with an end overlap 15 cm (6") and side overlap of two corrugations. Holes for nails, screws, rivets, etc., shall be punched on the ground (before taking in roof) in the ridges with very sharp punches from below upward in such a manner that the hole will come on the ridge of the sheets. The sheets shall be joined together with galvanized bolts

and nuts and with bitumen washer and G.I. washer and fixed to the purlins with galvanized hook bolts of J or L type of 8 mm (5/16") in diameter, with bitumen and lumpet washers.

Ridges and hips shall be covered by special ridge or hip sections and shall be bolted or clipped in the sheets, with a 30 cm (1 ft) lap on each side so as to prevent the rain driving under it. Wind ties of flat iron bar 40 mm x 6 mm (1½" x ¼") shall be fixed at the eave ends of the sheets and fixing shall be done with the same J or L hook bolts and nuts which secure the sheets with purlins.

Roofs shall not be pitched at the flatter slope than 1 in 5, the normal pitch being 1 in 2. For flatter pitch than 1 in 2½ the end overlap should not be less than 23 cm (9").

The finished surface shall be uniform and the lines of corrugations shall be straight and parallel.

Measurement shall be taken for the complete laid roof in sq m (sq ft) for the flat superficial area, not girted. Wind ties shall be measured under a separate item. Supporting purlins and structures shall be taken under separate item.

### 38. Allahabad tile roof—

The tiles shall be of Allahabad pattern well burnt, dark red in colour and shall give a clear ringing sound when struck. Wind ties shall be sound regular in shape and free from cracks, and shall not absorb water more than 1/6th of their weight.

Timber for battens shall be of the type specified may be of sal, shisham, deodar, trak, etc., and shall be of best quality, well seasoned and free from saps, cracks, knots, flaws and other defects. The battens shall be 30 mm x 45 mm (1½" x ¾") in section and fixed over 30 cm (1 ft) centre to centre over common rafters with nails. The spacing of common rafters shall not be more than 90 cm (3 ft). The eave batten shall be 45 mm x 60 mm in section. All battens shall be painted with two coats of approved paint over a coat of priming.

**Single tiling.**—Single tiling shall consist of layer of flat tiles laid closely on battens, and the adjacent edges of every two tiles shall be covered with semi-cylindrical tiles. All the lines of the tiles shall be straight in both directions and whole roof when laid must give a uniform appearance. The flat tiles must lap accurately at their ends one over the other. The moulded niche at the lower end of each flat tile must fit completely into the head of the tile next below it and the bottom of the tiles at the upper end must have a firm hold on the battens. Each semi-cylindrical tile must be exactly in its position on the flat tiles under it and also into the bed specially formed in the upper end of the next semi-cylindrical tile, to receive it. At the ridges and hips the tiles must abut closely. All ridges and hips shall be covered by ridges or hip tiles laid in lime mortar. The tiles over walls shall be laid in lime mortar and the ends of the semi-circular tiles at the eaves shall be filled with lime mortar for half their length. The under side of the flat tiles shall be finished with white washing.

The roof slope should not be less than 1 in 3 nor more than 1 in 2. The roof when completed shall be true to lines and slope, and shall be leak proof.

Measurement of the complete laid roof shall be taken flat in sq m (sq ft) including battens, ridges and hips.

**Double tiling.**—Double tiling shall consist of two layers. The bottom layer shall consist of a layer of flat tiles laid on battens and the side joints of every two adjacent flat tiles shall be covered by semi-hexagonal tiles. Over these semi-hexagonal tiles shall be laid an upper layer of flat tiles and the adjacent edges of every two of these flat tiles being covered with a semi-cylindrical tile. The other details are similar to single tiling.

**Ranigunge tiled roof—**

shall be of Mangalore pattern double channelled, well burnt, dark-red in colour and giving a ringing sound when struck. The tiles shall be sound, regular in shape and free from cracks. They shall not absorb water more than 1/6th of their weight. Ridge tiles and hip tiles shall also be of the same pattern.

Battens shall be similar to Allahabad tile roof, as in item 38 above.

Tiles shall be laid in such a way that they properly fit with each other in the grooves and rest on the battens. The edges of the adjoining tiles shall overlap giving water proof joints. At the ridges and hips the tiles should abut closely. The ridges and hips shall be covered by ridge hip tiles in cement mortar. The tiles over the walls and the lowest eave tiles shall be laid in lime mortar. The surface of the tiles shall be finished with white washing.

Measurement of the complete laid roof shall be taken in sq m (sq ft) including battens, ridges and hips.

Specification of Ranigunge tiled roof, Sialkot tiled roof and Quilon tiled roof are similar to Allahabad tiled roof.

**Earthwork in irrigation channels and road—**

Centre line of channel or road or bank and its edges (toes) shall be marked correctly and neatly by pegging. Outlines of borrowpits shall also be marked on the ground. Formation pillars of masonry shall be constructed at suitable points as directed by the Engineer-in-charge to serve as bench marks.

The whole area under cutting or filling shall be cleaned of all jungles, vegetations, rubbishes, loose stones and other materials. Roots of trees, if any, shall be removed to a depth of 60 cm (2 ft) below ground level. For banking the existing surface shall be ploughed to a depth of 15 cm (6") to make bond with new earth, and all clods broken and surface roughly levelled. Earthen or pole profiles shall be made 30 m to 100 m (100' to 300') apart and extra profiles may be made at curves or where there is change in direction or gradient. For banking settlement allowance shall be allowed and profiles shall show the total height including allowance for settlement. In case of ordinary hand rammed consolidated fills 10% settlement allowance and in case of consolidation by heavy machinery 5% settlement allowance shall be provided.

Bank shall be made in layers of 25 cm (9") thickness and each layer should be slightly concave towards the centre. In banking side slopes of 1½ : 1 to 2 : 1 should be given as specified depending on the nature of soil. All clods of earth shall be broken in borrowpit, and all roots, stones, etc., removed. Earthwork shall be done from the edge to the centre and each layer well rammed with wooden rammer of 5 to 8 kg (10 to 15 lb) weight. Thorough compaction if required shall be done by rolling each layer with sheep foot roller.

In cutting, first the central rectangular portion shall be excavated from top to bottom and then the side with side slopes of 1 : 1 to 1½ : 1 depending on nature of soil.

Depth of borrowpits should not be more than 30 cm (1 foot), spoil banks where required should be regular and of uniform height with the prescribed slope. Old and new bank shall be joined by stepping. If there is cutting and banking alternately, the cutting earth should be used for filling up to the economical limit. In irrigation channel the excavated earth should be utilised for side banks for which no extra payment shall be made.

Surface and side slopes shall be dressed and finished neatly. Rate shall include normal lead and lift of 30 m (100') lead and 1.5 m (5') lift. Profile or fill measurement allowing settlement allowance or borrowpit measurement shall be taken as specified. Where temporary land is costly borrowpit

may be made deeper on the approval of the Engineer-in-charge.

**41. Cement mortar—**

The proportion of cement and sand be as specified, may be of 1 : 2, 1 : 3, 1 : 4, 1 : 5 and 1 : 6. Cement shall be portland cement of standard specifications. Sand shall be clean and free from dust, dirt and organic matters and shall not contain more than 4% silt. Fine local sand may be used which shall pass through screen having 9 meshes per sq cm (64 meshes per sq in). Fineness modulus of sand shall not be less than 10.

The mixing shall be done first dry on a pucca platform and then with water. Cement and sand shall be measured with boxes to have the required proportion, sand spread out on the platform and the required quantity of cement spread on top of sand and the whole mixed dry. The dry mixture shall then be formed roughly into a hollow cone shape and water added slowly and gradually by a can, and the whole mixed thoroughly to have a uniform colour and consistency. Quantity of water should not exceed 30 litres (6 gls.) per bag of cement. One bag of cement (50 kg) shall be taken as 1/30 cu m (12 cu ft) and sand shall be measured with box to have the required proportion.

Mixing may also be done by means of mechanical mixer. In this process first about 5 to 10 per cent of water shall be put in the mixer and then sand and cement in the required proportion shall be added. Mixing will be continued until the mix becomes uniform in colour and consistency.

Only such quantity of mortar as can be used before setting begins, shall be mixed with water at one time. No mortar which has begun to set shall be used even after remixing, such set mortar shall be immediately removed from the site of work.

**42. White lime mortar—**

The mortar shall consist of freshly slaked white lime and surkhi or sand or cinder, of proportion 1 : 1, 1 : 2 and 1 : 3 as specified. The lime should be slaked at the site of work, and screened through a sieve of 9 meshes per sq cm (64 meshes per sq in), before mixing. Lime shall be free from ashes and organic matters. Surkhi, sand or cinder shall be clean and of standard specifications. The ingredients shall be first dry mixed by measuring with boxes to have the required proportion, and then mixed by grinding in masonry mortar mill for not less than 180 revolution by adding water to give a uniform plastic mix. Mortar for the day's work shall be mixed and used on the same day; no old and stale mortar shall be used, but removed from the site of work. For small work hand mixing in pucca platform may be done as in cement mortar above.

**43. Kankar lime mortar—**

The mortar shall consist of kankar lime alone or kankar lime and surkhi or sand or cinder in the proportion of 1 : 1 or 1 : 2 as specified. The materials should be clean and of standard specification. Kankar after burning shall be ground fine and screened through a sieve having 25 meshes per sq cm (144 meshes per sq in). The materials shall be measured with measuring boxes to have the required proportion and mixed by grinding in a masonry mortar mill continuously for two hours, with sufficient water to give a uniform plastic mix. Mortar for the day's work only shall be mixed and used on the same day; no old and stale mortar shall be used but removed from the site of works. Mortar shall have a minimum tensile strength of 7 kg per sq cm at 21 days. For small work hand mixing in pucca platform may be made.

**44. White lime—**

Lime shall be of freshly burnt lime stone of approved quarry. Lime should be fresh slaked. Unslaked white lime should be brought to the site of work and slacked on pucca platform and slaked at site and screened through a sieve of 9 meshes per sq cm (64 meshes per sq in) and residue

**39. Mangalore tiled roof—**

The tiles shall be of Mangalore pattern double channelled, well burnt, dark-red in colour and shall give a clear ringing sound when struck. The tiles shall be sound, regular in shape and free from cracks and shall not absorb water more than 1/6th of their weight. Ridge tiles and hip tiles shall also be of Mangalore pattern.

*Timber battens shall be similar to Allahabad tile roof, as in item 38 above.*

The tiles shall be laid in such a way that they properly fit with each other in the grooves and rest firmly on the battens. The edges of the adjoining tiles shall overlap giving water proof joints. At the ridges and hips the tiles should abut closely. The ridges and hips shall be covered by ridge hip tiles laid in lime mortar. The tiles over the walls and the lowest eave tiles shall be laid in lime mortar. The under side of the tiles shall be finished with white washing.

Measurement of the complete laid roof shall be taken in sq m (sq ft) including battens, ridges and hips.

*Specification of Ranigunge tiled roof, Sialkot tiled roof and Quilon tiled roof are similar to Mangalore tiled roof.*

**40. Earthwork in irrigation channels and road—**

Centre line of channel or road or bank and its edges (toes) shall be marked correctly and neatly by daggbellling. Outlines of borrowpits shall also be marked on the ground. Formation pillars of masonry shall be constructed at suitable points as directed by the Engineer-in-charge to serve as bench marks.

The whole area under cutting or filling shall be cleaned of all jungles, vegetations, rubbishes, loose stones and other materials. Roots of trees, if any, shall be removed to a depth of 60 cm (2 ft) below ground level. For banking the existing surface shall be ploughed to a depth of 15 cm (6") to make bond with new earth, and all clods broken and surface roughly levelled. Earthen or pole profiles shall be made 30 m to 100 m (100' to 300') apart and extra profiles may be made at curves or where there is change in direction or gradient. For banking settlement allowance shall be allowed and profiles shall show the total height including allowance for settlement. In case of ordinary hand rammed consolidated fills 10% settlement allowance and in case of consolidation by heavy machinery 5% settlement allowance shall be provided.

Bank shall be made in layers of 25 cm (9") thickness and each layer should be slightly concave towards the centre. In banking side slopes of 1½ : 1 to 2 : 1 should be given as specified depending on the nature of soil. All clods of earth shall be broken in borrowpit, and all roots, stones, etc., removed. Earthwork shall be done from the edge to the centre and each layer well rammed with wooden rammer of 5 to 8 kg (10 to 15 lb) weight. Thorough compaction if required shall be done by rolling each layer with sheep foot roller.

In cutting, first the central rectangular portion shall be excavated from top to bottom and then the side with side slopes of 1 : 1 to 1½ : 1 depending on nature of soil.

Depth of borrowpits should not be more than 30 cm (1 foot), spoil banks where required should be regular and of uniform height with the prescribed slope. Old and new bank shall be joined by stepping. If there is cutting and banking alternately, the cutting earth should be used for filling up to the economical limit. In irrigation channel the excavated earth should be utilised for side banks for which no extra payment shall be made.

Surface and side slopes shall be dressed and finished neatly. Rate shall include normal lead and lift of 30 m (100') lead and 1.5 m (5') lift. Profile or fill measurement allowing settlement allowance or borrowpit measurement shall be taken as specified. Where temporary land is costly borrowpit

may be made deeper on the approval of the Engineer-in-charge.

**41. Cement mortar—**

The proportion of cement and sand be as specified, may be of 1 : 2, 1 : 3, 1 : 4, 1 : 5 and 1 : 6. Cement shall be portland cement of standard specifications. Sand shall be clean and free from dust, dirt and organic matters and shall not contain more than 4% silt. Fine local sand may be used which shall pass through screen having 9 meshes per sq cm (64 meshes per sq in). Fineness modulus of sand shall not be less than 10.

The mixing shall be done first dry on a pucca platform and then with water. Cement and sand shall be measured with boxes to have the required proportion, sand spread out on the platform and the required quantity of cement spread on top of sand and the whole mixed dry. The dry mixture shall then be formed roughly into a hollow cone shape and water added slowly and gradually by a can, and the whole mixed thoroughly to have a uniform colour and consistency. Quantity of water should not exceed 30 litres (6 gals.) per bag of cement. One bag of cement (50 kg) shall be taken as 1/30 cu m (12 cu ft) and sand shall be measured with box to have the required proportion.

Mixing may also be done by means of mechanical mixer. In this process first about 5 to 10 per cent of water shall be put in the mixer and then sand and cement in the required proportion shall be added. Mixing will be continued until the mix becomes uniform in colour and consistency.

Only such quantity of mortar as can be used before setting begins, shall be mixed with water at one time. No mortar which has begun to set shall be used even after remixing, such set mortar shall be immediately removed from the site of work.

**42. White lime mortar—**

The mortar shall consist of freshly slaked white lime and surkhi or sand or cinder, of proportion 1 : 1, 1 : 2 and 1 : 3 as specified. The lime should be slaked at the site of work, and screened through a sieve of 9 meshes per sq cm (64 meshes per sq in), before mixing. Lime shall be free from ashes and organic matters. Surkhi, sand or cinder shall be clean and of standard specifications. The ingredients shall be first dry mixed by measuring with boxes to have the required proportion, and then mixed by grinding in masonry mortar mill for not less than 180 revolution by adding water to give a uniform plastic mix. Mortar for the day's work shall be mixed and used on the same day, no old and stale mortar shall be used, but removed from the site of work. For small work hand mixing in pucca platform may be done as in cement mortar above.

**43. Kankar lime mortar—**

The mortar shall consist of kankar lime alone or kankar lime and surkhi or sand or cinder in the proportion of 1 : 1 or 1 : 2 as specified. The materials should be clean and of standard specification. Kankar after burning shall be ground fine and screened through a sieve having 25 meshes per sq cm (144 meshes per sq in). The materials shall be measured with measuring boxes to have the required proportion and mixed by grinding in a masonry mortar mill continuously for two hours, with sufficient water to give a uniform plastic mix. Mortar for the day's work only shall be mixed and used on the same day, no old and stale mortar shall be used but removed from the site of works. Mortar shall have a minimum tensile strength of 7 kg per sq cm at 21 days. For small work hand mixing in pucca platform may be made.

**44. White lime—**

Lime shall be of freshly burnt lime stone of approved quarry. Lime should be fresh slaked. Unslaked white lime should be brought to the site of work and slacked on pucca platform and slaked at site and screened through a sieve of 9 meshes per sq cm (64 meshes per sq in) and residue

on the screen rejected. Lime shall be free from ashes and other foreign matters. Lime should be stored in a covered weather proof shed. Tank slaking may be done if specified and lime putty may be used.

#### 45. Kankar lime—

Kankar lime should be made from "bichwa" kankar free from earth and other impurities. Kankar should be burnt in kiln and then ground fine and screened through sieve of 25 meshes per sq cm (144 meshes per sq in) and the residue on the screen rejected. Kankar lime shall be clean and free from dirt, dust and foreign matters. Kankar lime mortar briquette should give a tensile strength of 7 kg per sq cm at 21 days.

#### 46. Brick ballast—

Brick ballast shall be broken to the specified gauge from dense over-burnt or well-burnt bricks or brick bats of copper colour or deep cherry red colour. No under burnt porous or jhanna bricks, or bricks showing signs of saltpetre shall be used. The ballast shall be free from dust, dirt and foreign matters. For foundation 40 mm (1½") gauge and for roof terracing 25-mm (1") gauge well graded brick ballast should be used.

#### 47. Surkhi—

Surkhi shall be made from fully burnt bricks but not over-burnt bricks. Surkhi shall be ground fine and after grinding, shall be screened through sieve of 25 meshes per sq cm (144 meshes per sq in) and residue on the screen shall be rejected. Surkhi shall be clean and free from foreign matters. Surkhi shall be stacked on brick platform and protected from earth dirt, etc.

#### 48. Cinder—

Cinder should be made from coal-ash and should be free from burnt clay, wood ash, dirt and foreign matters. Cinder should be obtained from furnaces using coal fuel only. Cinder should be ground fine and screened through sieve of 9 meshes per sq cm (64 meshes per sq in) and residue in the sieve should be rejected. Cinder shall not contain more than 10% of unburnt carbon (combustible matter).

#### 49. Sand—

Sand shall be clean hard, durable, angular, sharp and gritty to touch and free from mica, salts, alkalis, organic and vegetable matters. It should not contain more than 5% of clay or silt. Sand should be perfectly dry before being measured. If damp sand is used, compensation shall be made for bulking by adding additional sand up to the extent of bulking. Sand shall be natural river sand or pit sand of approved quality.

For concrete coarse sand of maximum size of 5 mm (5/16") shall be used. All sand shall pass through a sieve of 5 mm (3/16") sq mesh and 60% retained on I.S. sieve 60 (B.S. 25). Fineness modulus of coarse sand shall not be less than 2.5.

For brickwork or masonry and for plastering or pointing fine or medium sand shall be used. This shall be screened through a sieve having 9 meshes per sq cm, and the bigger particle excluded and rejected. Fine sand should not pass more than 20% through a sieve of 400 meshes per sq cm and not more than 5% should pass through a sieve of 1600 meshes per sq cm. Fineness modulus of fine sand should not be less than 1.0.

#### 50. Determination of silt contents of sand by field test—

Take a (narrow long) glass measuring cylinder (say 200 ml) fill half the cylinder with sample of sand (100 ml mark), add clean water up to ¾" height of cylinder (150 ml mark), shake vigorously allow the contents to settle for 3 hours. Coarse particle settle first at the bottom and gradually the finer particles and finally the silt at the top. The height of the silt layer ( $h$ ) as visible above the sand is

measured from the graduations of the cylinder and expressed as percentage of the height ( $H$ ) of the sand below :—

$$\text{Percentage of silt content} = \frac{h}{H} \times 100.$$

If the percentage of silt content is above the allowable percentage, then the sand should be washed to remove the silt.

#### 51. Determination of bulking of damp sand by field test—

Take a glass measuring cylinder and fill three-fourth of the cylinder with the sand under test and lightly tap the cylinder and read the volume of sand (say  $V$ ). Then pour water in the cylinder to submerge the sand and stir the sand well and allow to settle and then read the volume of sand (say  $v$ ). When the sand is fully saturated by submerging its volume is same as dry volume.

The difference in the original volume and final volume is the bulking and the percentage of bulking is  $\left[ \frac{V-v}{v} \times 100 \right]$

*Note—For specifications of Mud roof, Mud wall, Mud plaster, etc., Chapter on Village Housing given at the end may be consulted.*

### ROAD SPECIFICATIONS

#### GENERAL SPECIFICATION OF MODERN ROAD

1. **Subgrade**—Shall be well consolidated and compacted each with a camber of 1 in 60.
2. **Soiling**—Shall be 30 cm (1') wider than the metalled width of the road surface, and may be either of :—
  - (i) Over burnt bricks laid flat or on edge well packed and joints filled up with sand and the surface blinded with 2.3 cm (1") thick earth and lightly rolled with roller.
  - Or
  - (ii) Split stone boulders 15 cm (6") thick laid well packed, and the surface blinded with earth and rolled with roller.
3. **Inter coat**—Shall be of stone ballast, or over burnt brick ballast of 12 cm (4½") thick layer and consolidated and compacted by road roller to 8 cm (3").
4. **Top coat**—Shall be of stone ballast laid in 12 cm (4½") thick layer and consolidated and compacted by road roller to 8 cm (3").
5. **First coat of bituminous painting**—Shall be with Asphalt or Road Tar No. 3 and stone grit of 20 mm (¾") gauge at 220 kg of asphalt and 1.35 cu m of stone grit per 100 sq m.
6. **Second coat of bituminous painting**—Shall be with Asphalt or Tar No. 3-A and stone grit of 12 mm (½") gauge at 120 kg of asphalt and 0.75 cu m of stone grit per 100 sq m.
7. **Brick edging**—Brick edging with straight overburnt bricks shall be provided on both sides.

8. If traffic is heavy instead of bituminous painting the wearing surface may be provided with bituminous carpet or cement concrete.

9. If subgrade is soft or weak, a thick sub-base of cheap and inferior materials well compacted should be used.

#### DETAILED SPECIFICATION OF ROAD WORK

1. **Overburnt bricks.**—I-class over burnt bricks made from good brick-earth shall be used. The brick-earth shall be free from gravel, kankar and other materials. All bricks shall be overburnt, of copper colour, no Jhama or under-burnt brick shall be used.

2. **Overburnt brick ballast.**—I-class brick ballast of 50 mm (2") gauge, broken at site from well overburnt bricks of copper colour shall be used. No Jhama or underburnt ballast should be used. Brick ballast shall be homogeneous in texture and roughly cubical in shape. Ballast shall be clean and free from dust, etc., and shall be stacked 30 cm (12") high on the levelled side-berm along the road having the section as required per metre length for the full width of metalling. The stack should be continuous without any gap. For 3.70 metres wide road and 12 cm loose layer the stack may be trapezium section of 1 m width 1.48 m bottom width and 30 cm high.

3. **Stone ballast.**—Hard, rough and durable granite stone ballast 60 mm gauge, shall be used. Ballast should not absorb water and should not be effected by weather action and shall be clean and free from dust, dirt, etc. Ballast should be stacked 30 cm (12") high on the levelled side-berm of the road in a continuous stack along the road having the section as required per metre length of the road. Size of stack may be similar as for brick ballast.

4. **Kankar.**—Good hard Bichwa kankar 65 mm to 20 mm ( $2\frac{1}{2}$ " to  $\frac{3}{4}$ " gauge, free from earth, dust, dirt, etc., should be used. Kankar should show a bluish surface on fracture. Kankar shall be stacked 32 cm (13") high on the levelled side-berm along the road, and measured as 30 cm (12") high. Kankar should be cleaned and broken to gauge at the quarry and then carried to the road side, and cleaned again before stacking and the stack should be made continuous without having any gap. The top width and bottom width of stack may be 1 m and 1.48 m respectively and the height will be 32 cm.

5. **Laying and consolidation of road metal, stone ballast or brick ballast.**—Laying and consolidation shall be done during early rainy season, so that sufficient water is available for consolidation, and during the later part of the rains the ballast gets fully compacted. The surface shall be made to a camber of 1 in 60 or 1 in 48 as specified and two mud walls 20 cm (8") wide and 15 cm (6") high shall be made along the outer edges for the metalling and ballast spread evenly hand packed to the required camber with template and bigger pieces of metal placed at the bottom. The ballast shall first be dry rolled longitudinally with 10 tonne roller commencing from the edges and working towards the centre, and dry rolling continued until the metal is thoroughly compacted. The metal shall then be fully saturated with water and rolled until thoroughly compacted and no mark of roller left on the surface. Rolling should be done slowly without any jerk. For checking consolidation a few pieces of stones shall be placed over the surface and roller passed over them, the stones shall not sink if consolidation is perfect. The surface shall then be thinly blinded with sandy earth and watered and rolled. Finally the side mud walls shall be rolled and pressed flush to the surface. The surface should be brought to the required camber by placing template at regular intervals. The road shall be opened to traffic when dry but still damp, and the traffic should be spread over the full width by traffic diversion (likh katai). The paties or side-berms shall be repaired with earth to a slope of 1 in 36.

6. **Laying and consolidation of kankar metal.**—The laying and consolidation of kankar shall be done during the early rains so that sufficient water is available for consolidation and during later part of the rains kankar metal gets fully compacted.

The kankar stacks shall be opened before rain starts and sorted in three rows as follows :—

- (i) Largest kankar (size 63 mm to 40 mm) to be used at the bottom.
- (ii) Intermediate or medium size kankar (size 40 mm to 25 mm) to be used in the middle.
- (iii) Smallest size kankar (25 mm and below) to be used at top.

The surface should be brought to the required camber and two mud walls 20 cm (8") wide and 15 cm (6") high shall be made along the outer edges of metalling and the surface cleaned, and then kankar spread in three operations, first the big size kankar then the medium size kankar and finally at the top small size kankar and the surface brought to camber with template placed at 10 m (30 ft) apart. Kankar is then fully saturated with water and consolidated with rammers of 5 to 8 kg (10 to 15 lbs) weight and 16 rammers shall be used for the 3.7 m (12 ft) wide road. The ramming shall be done first at the side (haunches), to width of 1 m (3 ft) on each side working along the road, and then the central portion working across the road. The ramming is continued until the metal has been thoroughly compacted and no marks are left by the rammers or by any traffic moving over the new surface. When the consolidation is completed the mud walls shall be rammed flat with the metal surface and the surface blinded with standy soil. No blinding should be done on kankar surface during consolidation.

The road shall be opened to traffic when the surface is dry but still damp. The traffic shall be spread over the full width by traffic diversion (likh katai). The paties or sides-berms shall be repaired with earth to a slope 1 in 36.

7. **First coat of painting or surface dressing with bitumen.**—The surface shall be bone dry and absolutely free from dust, dirt, cowdung, etc. The cleaning shall be done first by wire brushes then by hard brush brooms and then with soft brush, so as to expose clean metal surface to a depth of 6 mm to 12 mm ( $\frac{1}{4}$ " to  $\frac{1}{2}$ ") without loosening the stone. Finally, immediately before painting all dust, dirt, etc., should be blown away with blower or blowing with gunny bags.

Road Tar No. 3 heated to a temperature of 200° to 225°F, or Asphalt, 80/100 heated to 350° to 375°F, shall be applied to the road surface uniformly along the road with pouring cans or with hose pipe directly connected with tar boiler, and brushed evenly over the surface with brush brooms or rubber squeegees working from edge to the crown of the road. For proper control and uniformity of spreading of tar, the surface area which can be covered by one can marked with chalk, or the length which can be covered by one drum of tar should be marked. About 220 kg of tar or asphalt are required per 100 sq m of surface (45 lbs % sq ft.).

As soon as the paint (Tar or Asphalt) has been applied, stone grits 20 mm to 6 mm ( $\frac{3}{4}$ " to  $\frac{1}{4}$ ") gauge, should be spread evenly on the surface. The grit should be screened into two portions, bigger and smaller pieces before hand. The bigger grits shall be spread first and then the smaller grits at the top. The surface shall then be rolled slowly and lightly with light road roller just to press the grits into the paint and to give a uniform smooth surface. The quantity of stone grits should be 1.35 cum per 100 sq m (4.4 cu ft % sq ft). If any signs of bleeding is developed anywhere on the surface, the spot should be covered with small stone grits or coarse sand and lightly compacted. Road may be opened to traffic after 12 hours of rolling.

No painting shall be done during December and January. No hot painting shall be done during rainy season.

8. **Second coat of painting or surface dressing with bitumen.**—The second coat of painting shall be applied when all loose grits of the first coat have been absorbed and the surface shows a mosaic



appearance. The second coat of painting shall be done with asphalt of 80/100 penetration heated to 350°F to 375°F, and 120 kg of asphalt should be applied per 100 sq m of surface (25 lbs % sq ft) and 0.75 cu m stone grits of 12 mm to 3 mm ( $\frac{1}{2}$ " to  $\frac{3}{8}$ ") gauge shall be used per 100 sq m of surface (2.2 cu ft % sq ft). The preparation of surface, the application of paint and the gritting shall be done by the same methods and operations as for the first coat of painting.

Tar No. 3-A heated to 220° to 240°F may also be used for 2nd coat of painting.

**Precoated grits.**—Stone grits used for 1st coat and 2nd coat surface painting may be precoated in advance with bitumen, precoating prevents separation and disintegration of grits and improves the life of the road. For precoating stone grits 12 kg to 16 kg of asphalt or road tar per cu m of grit (0.75 to 1.00 lb per cu ft) may be used. (U.P., P.W.D. Research Directorates).

**9. 2 cm ( $\frac{3}{4}$ ") premix chips carpet or precoated chip surface dressing.**—First a tack coat should be applied on the clean surface and immediately after that premix carpet should be laid, which should be compacted by rolling and then followed by sand flushing. The stone chips and sand used should be dry. The detailed operations are as follows :—

**Preparation of base.**—The surface should be done dry and must be absolutely free from dust, dirt, caked mud, etc. Cleaning should be done first by wire brushes, then by hard brush brooms and then with soft brush brooms and finally blowing with a blower or dusting with bags. Pot holes or ruts in the surface should be filled with a premix chippings and well rammed about a week before the carpet is laid.

#### TACK COAT

Binder, shelmac or shelspra heated to a temperature of 320° to 340°F (or Tar No. 3-A heated to 220° to 240°F) should be applied on the cleaned surface uniformly at the rate of 100 kg per % sq m (20 lbs per % sq ft). Application should be made with sprayer but if this is not available, with pouring can and brushed evenly. The tack coat should be applied just ahead of spreading carpet.

#### CARPET

**Preparation of premix.**—Two parts of stone chips 12 mm ( $\frac{1}{2}$ ") size (passing 20 mm mesh and retained on 12 mm mesh) and one part of stone chips 10 mm ( $\frac{3}{8}$ ") size (passing 12 mm mesh and retained on 3 mm mesh) shall be loaded in drum mixer and thoroughly mixed dry. The stone chips should be angular, hard tough and durable and perfectly clean. Stone chips need not be heated but should be perfectly dry.

The binder @ 56 kg per cu m (@  $3\frac{1}{2}$  lbs per cu ft) of chips, shelmac or shelspra heated to a temperature of 320° to 340°F (or Tar No. 3-A heated to 220° to 240°F) shall be poured into the mixer and thoroughly mixed until the stone chips are thoroughly coated with binder.

The mix shall then be discharged from the mixer on wheel-borrows or stretchers and carried to the site.

For 100 sq m of premix carpet surface 1.8 cu m of 12 mm size stone chips, 0.9 cu m of 10 mm size stone chips and 155 kg of bitumen shall be required.

If mechanical mixer is used larger quantity can be mixed at a time.

**Spreading of premix.**—Immediately after applying the tack coat to the road surface the hot premix shall be spread evenly with rakes to the desired thickness and to the correct camber and checked by template. Any unevenness on the surface shall be adjusted by adding premix before rolling commences.

**Rolling.**—As soon as sufficient length (15 m) of premix has been laid, rolling should be started with 7 to 8 tonne roller. Rolling should commence at the edges and progress towards the centre. After light rolling high spots or depressions which become apparent should be corrected by removing or adding premix and then rolled to thorough compaction. Excessive rolling should be avoided. Roller wheel should be kept damp to prevent the premix from adhering and picking up.

#### SAND FLUSHING

Over this compacted surface immediately after rolling, dry coarse sand should be spread at the rate of 0.3 cu m per % sq m (1 cu ft per % sq ft) and rolled again until a smooth surface is obtained. Sand should be coarse, clean, hard, durable and free from dust, dirt and organic matter.

Traffic may be allowed on the carpet surface after 24 hours of completion of rolling.

**Seal coat.**—A seal coat shall be applied as soon as found necessary but not later than 1½ years after laying the carpet. The binder shelspra or shelmac or Tar No. 3-A should be heated (as for tack coat) and mixed with dry coarse sand (or 6 mm size stone chips) and then spread on the road surface uniformly and rolled. The quantity of sand and binder should be at the rate .75 cu m of sand per % sq m (2.5 cu ft % sq ft) of surface and 128 kg of bitumen (binder) per cu m of sand (8 lbs per cu ft).

Instead of seal coat of premix and binder, a coat of surface dressing may be applied as in second coat of painting, item No. 8.

#### Cold-mix and Hot-mix Premix Carpeting—

**Cold-mix.**—The above specifications of premix bituminous road is for Cold-mix type in which stone chips or aggregates are not required to be heated. Bitumen should be of the quality and grade such that the heated bitumen when mixed with cold (atmospheric temperature) and dry stone chips they will be well coated and form a good mix and will not harden by the time the mix is applied on the road surface and rolled. Shelspra, shelmac and Road Tar No. 3-A possess quality for Cold-mix.

**Hot-mix.**—Hot-mix type may be used with suitable quality and grade of asphalt where both the binder and the aggregate shall have to be heated separately and then mixed together, and then carried and applied on the road surface while hot and rolled.

**Stabilized Soil Road.**—See Chapter 19 Village Housing.

#### REQUIREMENTS OF DIFFERENT CLASSES OF ROADS

The requirements of different classes of roads are as follows :—

Particulars	National Highway (N.H.) and State Highways (P.H.)	Major District Road (M.D.R.)	Other District Road (O.D.R.)	Village Road (V.R.)
1. Controlled land width against ribbon development in open country	70 metres from centre of road on either side—			
2. Width of permanent land—Minimum	30 m	30 m	24 m	12 m

Particulars	National Highway (N.H.) and State Highways (P.H.)	Major District Road (M.D.R.)	Other District Road (O.D.R.)	Village Road (V.R.)
Minimum in uncultivated or Usar areas	45 m	30 m	30 m	12 m
3. Width of road foundation in plains	10 m	10 m	10 m	5 m
Width of road formation in Hills	5.5 m-7.5 m	5.5 m-7.5 m	2 m for Bridle road	Bridle road
4. Minimum height of bank above flood level	60 cm	60 cm	45 cm	30 cm
5. Width of metalled surface— Single Lane	3.70 m	3.70 m	3.70 m	—
Double Lane	7.00 m	7.00 m	—	—
6. Minimum thickness of metal crust compacted (in three layers)	24 cm	24 cm	24 cm	—
7. Width of soling coat	30 cm more than metalled		width	—
8. Camber or cross slope of metalled surface	W.B. kankar W.B. stone Bituminous Cement concrete		1 in 36 1 in 48 1 in 60 1 in 72	—
9. Maximum gradient in plains	1 in 30	1 in 30	1 in 30	1 in 10
Maximum gradient in hills	1 in 15	1 in 15	1 in 7	1 in 7
Ruling gradient in plains	1 in 40	1 in 40	1 in 40	1 in 20
Ruling gradient in hills	1 in 20	1 in 20	1 in 10	1 in 10
10. Visibility at vertical curves minimum	100 m	100 m	100 m	—
11. Minimum radii of curves— In plains	300 m	200 m	200 m	50 m
In hills	20 m	20 m	20 m	16 m
12. Maximum super-elevation— In plains	1 in 20	1 in 20	1 in 20	—
In hills	1 in 8	1 in 10	1 in 10	—
13. Design load for bridges and culverts	I.R.C. Class-A loading	I.R.C. Class-A loading	I.R.C. Class-B loading	Live load of 500 kg per sq m

Particulars	National Highway (N.H.) and State Highways (P.H.)	Major District Road (M.D.R.)	Other District Road (O.D.R.)	Village Road (V.R.)
14. Road width over culverts— In plains	10.00 m	10.00 m	10.00 m	5 m
In hills (minimum)	5.50 m	5.50 m	5.50 m	4 m
15. Road width over bridges— In plains	7.50 m	7.50 m	7.50 m	5 m
In hills (minimum)	4.30 m	4.30 m	4.30 m	4 m
16. Approaches to bridges and culverts	Minimum straight level length of 30 m on either side			—
17. Kilometre and half kilometre stone	At every half kilometre			—
18. Boundary stones	At every hectometre (100 m) and at changes in land width and curves			—
19. Gang huts	At every 15 kilometres apart			—
20. Overseer's Rest House	At every 30 kilometres apart			—
21. Inspection House	At every 40 kilometres as far as possible close to town.			—
22. Arboriculture— Distance on either side from centre	11 m	11 m	9 m	—
Distance apart along road	12 m	12 m	12 m	—
23. Side slopes of earthen formation— In banking	2 : 1	to 1½ : 1	depending on the nature of soil.	—
In cutting	1½ : 1	to 1 : 1		—

Note.—Thickness of metal crust should be designed taking the intensity of traffic into consideration and working out P.L., C.B.R. value, etc., of the soil (See Chapter 16).

Culverts and minor bridges should be provided in the road estimate. For major bridges separate estimate should be prepared.

## RULES AND METHODS OF MEASUREMENT OF WORKS AND TAKING OUT QUANTITIES

(Based on Indian Standard—IS : 1200 may be referred)

Measurement of works occupies a very important place in the planning and execution of any work or project, from the time of the first estimate are made until the completion and settlement of payments. The methods followed for the measurement are not uniform and the practices as prevalent differ considerably in between the States. Even in the same state different departments follow different methods. For convenience a uniform method should be followed throughout the country. The uniform methods of measurement to be followed which is applicable to the preparation of the estimates and bill of quantities and to the side measurement of completed works have been described below.

### GENERAL RULES

1. Measurement shall be item wise for the finished item of work and the description of each item shall be held to include materials, transport, labour, fabrication, hoisting, tools and plants, overheads and other incidental charges for finishing the work to the required shape, size, design and specifications. The nomenclature of each item shall be fully described so that the work involved in item is self-explanatory.

2. In booking dimensions the order shall be in the sequence of length, breadth and height or depth or thickness.

3. All work shall be measured net subject to following tolerances unless otherwise stated—

- (a) Dimensions shall be measured to the nearest 0.01 metre, i.e., 1 cm ( $\frac{1}{2}$ ").
- (b) Areas shall be measured to the nearest 0.01 sq m (0.1 sq ft).
- (c) Cubic contents shall be worked up to the nearest 0.01 cu m (0.1 cu ft).

4. Same type of work under different conditions and nature shall be measured separately under separate items.

5. The bill of quantities shall fully describe the materials, proportions and workmanships, and accurately represent the work to be executed. Work which, by its nature cannot be accurately taken off or which requires site measurements, shall be described as *Provisional*.

6. In case of structural concrete, brickwork or stone masonry, the work under the following categories shall be measured separately and the heights shall be described—

- (a) from foundation to plinth level; (b) From plinth level to first floor level; (c) From first floor level to second floor level and so on.

The parapet shall be measured with the corresponding items of the story next below—

**Principle of units—**The units of different works depend on their nature, size and shape. In general the units of different items of work are based on the following principle :—

- i) Mass, voluminous and thick works shall be taken in cubic unit or volume. The measurement of length, breadth and height or depth shall be taken to compute the volume or cubic contents (cu m).
- ii) Shallow, thin and surface work shall be taken in square units or in area. The measurement of length and breadth or height shall be taken to compute the area (sq m).
- iii) Long and thin work shall be taken in linear or running unit, and linear measurement shall be taken (running metre).
- iv) Piece work, job work, etc., shall be enumerated, i.e., taken in number.

### EARTHWORK

Earthwork shall be taken in cu m (cu ft) and the length, breadth and height or depth shall be measured to get the cubic content.

Earthwork of different nature as in excavation in foundation, in trenches, etc., and in filling in plinth, in banking, etc., shall be measured under separate items.

Earthwork in different kinds of soil as ordinary soil, hard soil, ordinary rock, hard rock, etc., shall be classified separately and measured under separate item.

Excavation shall include throwing of the excavated earth at least one metre clear of the edge of excavation.

Dressing or trimming and levelling or grading, ramming and consolidation thickness of each layer, etc., shall be described and included in the item of earthwork.

Measurement of excavation or trenches or borrowpits shall be taken for average dimensions. When the ground is fairly uniform 'Deadmen' or 'Tell-Tales' which shall be left at suitable intervals to determine the average depth of excavation. For uneven or sloping ground diagonal 'Tell-Tales' shall be left.

No deduction shall be made for *Deadmen, Tell-Tales*, which shall be removed after the measurements have been taken and checking has been completed.

When the ground is very uneven levels shall be taken before the start and after the completion of the earthwork by levelling instrument and the average depth of excavation or filling shall be determined from these levels.

Whenever it is not possible or convenient to make measurements from cutting the filling or banking shall be measured and deduction for shrinkage or voids (settlement allowances) shall be made from actual measured cubic contents depending on the nature of the soil and methods of consolidation. Generally 10% deduction shall be made in case of ordinary consolidated fills and in case of consolidation done by heavy machinery a deduction of 5% shall be made.

For road earthwork in banking, the profile or fill measurement may be taken and usual settlement or shrinkage allowance shall be given. The volume or quantity shall be obtained by multiplying sectional area by the length.  $\text{Quantity} = \text{Length} \times \frac{1}{2} (\text{Top width} + \text{Bottom width}) \times \text{Height}$ .

No separate measurement shall be taken, for setting out works, profiles, site clearance, deadmen, stepping, removal of slips or falls, bailing out water from rains, etc., these are included in the rate.

**Lead and lift—**The measurement shall be taken separately for every 30 m (100 ft) lead or distance and every 1.5 m (5 ft) lift or height or depth. The lead shall be measured from the centre of

the area of excavation to the centre of the area of spoil heap. Similarly lift shall be measured from the centre of excavation to the centre of spoil heap.

The normal rate is for each unit of 30 m (100') lead and 1.5 m (5') lift. For greater lead or lift, the rate shall be different for every unit of 30 m (100 ft) lead, and for every unit of 1.5 m (5 ft) lift.

*L.S.I. specifies the unit of lead as 50 m, measured over the shortest practicable route.*

**Foundation trench**—Unless otherwise specified the foundation trench shall be measured in cu m for rectangular section, bottom width being width of concrete and the depth shall be measured as vertical depth even though the contractor might have excavated with sloping sides for convenience.

**Return, fill and ram**—Returning, filling and ramming excavated earth shall be taken in cu m (cu ft) under a separate item and shall include spreading in layers of 20 cm (8") in depth, watering, ramming and levelling.

**Puddling**—Clay puddle work shall be taken in cu m (cu ft) and shall be described including supply of clay, its preparation, placing in layer of 15 cm (6"), ramming, etc.

**Surface dressing**—Trimming and dressing of natural ground to remove vegetation and small irregularities not exceeding 15 cm (6") deep shall be taken in sq m (sq ft) under a separate item 'Surface Dressing'.

Cutting down trees exceeding 30 cm (12") girth shall be accounted separately and enumerated, i.e., taken in numbers, stating the girth at 1 m (3') above ground and paid separately.

**Surface excavation**—Excavation exceeding 1.5 m in width as well as 10 sq m in plan but not exceeding 30 cm in depth shall be described as *Surface excavation* and measured in sq m.

**Pumping**—When spring water requires pumping the work of pumping or dewatering shall be taken under a separate item.

**Timbering**—Timbering or 'Planking and Strutting' for protecting the sides of trench or loose earth, shall be measured in sq m of face supported, and shall be classified under separate items as:—

- (a) Depth not exceeding 1.5 m; (b) Depth exceeding 1.5 m but not exceeding 5 m; (c) Depth exceeding 5 m.

Timbering shall include all necessary timber work including walls, struts, poling boards, etc. Both sides of trench shall be taken as one side area and shall be equal to length  $\times$  depth of timbering.

### CONCRETE

For concrete kind, size, grading and proportion of materials, method of mixing, cutting, etc., shall be described. Different kinds of concrete work as Lime concrete, Cement concrete, Reinforced cement concrete, etc., of different proportions, different materials shall be taken under separate items. Concrete foundation, roof, wall, mass concrete, etc., shall be classified and measured under separate items.

Concrete shall be taken in cu m (cu ft) and measurements of length, breadth and height or thickness shall be taken to the nearest 1 cm ( $\frac{1}{8}$ "), except that the thickness of slabs, partitions, post, beams, and the like shall be measured to the nearest 0.5 cm ( $\frac{1}{4}$ "). No deduction shall be made for openings up to 0.1 sq m (1 sq ft).

Formwork, centering and shuttering shall be taken under separate item in sq m (sq ft) unless otherwise herein provided. Formwork shall be measured as the actual surface in contact with the concrete. For slabs vertical sides (edges) shall not be measured.

Fair finish to the exposed surface of concrete or backing or roughening surfaces of concrete shall be included in the description and the thickness of finishing shall not be measured with the concrete. Special finishes, except in precast concrete shall be measured separately in sq m (sq ft).

**R.C.C. work**—Reinforced cement concrete shall be kept separate from unreinforced concrete. R.C.C. work shall be taken in cu m (cu ft) excluding steel and the steel reinforcement shall be measured under a separate item in quintal (cwt) authorised overlaps hooks cranks, etc., of bars shall be measured. Normally, centering and shuttering (formwork) shall not be measured separately but included in the rate of R.C.C. or C.C. work. Binding wire is not measured separately. The volume occupied by reinforcement shall not be deducted from the measured concrete volume. The item of R.C.C. work shall include R.C.C. slabs, beams, lintels, columns, chujjas, staircases, foundation, rafs and footings, etc., and each of them shall be classified under a separate item. The exposed surface shall be fair finished which shall not be measured separately. Chujjas may be measured in running metre stating the projection and its average thickness, if specified.

Special light weight partitions shall be measured in sq m stating thickness and fully described.

**Precast cement concrete**—Precast C.C. reinforced or plain shall be taken separately in cu m (cu ft) and shall be described as including all moulds, finished faces hoisting and setting in position. Reinforcement if any shall be described and included in the item or measured separate if specified.

**Expansion joints**—Expansion joints in roofs, floors, walls, road, etc., shall be measured in running metre (r ft), the depth and width of joint and materials used for filling shall be described.

**Joints**—Jallies or Jalfries, louvers shall be described and thickness specified and taken in sq m (sq ft). Reinforcement shall be described and included in the item.

**Concrete posts**—Fencing posts, corner posts, struts etc., shall be taken in cu m and reinforcement and formwork shall be included and described.

**Concrete piles**—Concrete piles shall be described and taken in cu m (cu ft) and classified according to the section and length. Steel reinforcement shall be included with the item and fully described.

Head and shoes of steel or iron shall be enumerated, i.e., taken in numbers and weight of each stated.

Pitching and driving of piles shall be enumerated stating size and length. If specified the driving of piles may be taken and measured in running metre for the portion driven below ground level.

**Damp proof course**—Damp proof course shall be fully described and taken in sq m (sq ft) stating the thickness. The item shall include formwork finishing, levelling, curing, etc. The horizontal and vertical damp proof courses shall be measured separately.

### BRICKWORK

The description of the bricks, and of the materials of mortar with proportion shall be stated. Different kinds and classes of brickwork shall be taken under separate items. The brickwork of

foundation and plinth, of first floor, of second floor, etc., shall be measured under separate items. Scaffolding works are not measured separately but included in the item of brickwork.

Brickwork shall be taken in cu m (cu ft), and measurements of length, breadth or thickness and height shall be taken to compute the quantity. The length and height shall be measured to the nearest 1 cm ( $\frac{1}{2}$ ").

**Thickness of wall**—Brick walls upto and including three bricks in thickness shall be measured in multiples of half brick, which shall be deemed to be inclusive of the mortar joint. The following shall be taken as brick measurement :—

For brick nominal size 22.9×11.4×7.6 cm (9"×4½"×3"), Half brick size is 11.4 cm (4½").

For brick nominal size 22.5×12.7×7.6 cm (10"×5"×3"), Half brick size is 12.7 cm (5").

For module bricks 20 cm×10 cm×10 cm  
(actual size 19 cm×9 cm×9 cm)

Thus for different bricks

One brick wall shall be measured as

One and half brick wall shall be measured as

Two brick wall shall be measured as

Two and half brick wall shall be measured as

Three brick wall shall be measured as

Half brick size in 10 cm

20×10×10 cm 9"×4½"×3"

20 cm 22.9 cm (9")

30 cm 34.3 cm (13½")

40 cm 45.7 cm (18")

50 cm 57.1 cm (22½")

60 cm 68.6 cm (27")

For walls which are more than three bricks in thickness, the actual thickness shall be measured to the nearest 1 cm ( $\frac{1}{2}$ ").

Where functions of half brick occur due to architectural or other reasons, the measurements shall be taken as follows :—

(a) For fractions of 2 cm under actual measurement.

(b) For fractions exceeding 2 cm—full half brick.

**Deduction**—No deduction or addition shall be made for the following :—

(a) Opening up to 0.1 sq m (1 sq ft) in section.

(b) Ends of joints, beams, lintels, posts, rafters, purlins, corbels, steps, etc.

(c) Wall plates and bed plates, bearing of slabs, chajjas and the like where the thickness does not exceed 10 cm and the bearing does not extend over the full width (thickness) of wall.

**Fire place, chimneys, etc.**—Brickwork shall be measured as solid in cu m (cu ft) if smoke or airflues do not exceed 0.25 sq m (2.5 sq ft) in sectional area, no deduction shall be made for flues and no extra payment shall be made for pargetting and coring of flues. When flues exceed 0.25 sq m (2.5 sq ft) in sectional area deduction shall be made for the core opening and pargetting and coring of flues taken separately in running metre (r ft) stating the size of flue.

**Pillars**—The pillars shall be measured in cu m (cu ft) for their net volume and fully described.

**Arches and vaults**—Brickwork in arches and vaulting shall be measured in cu m (cu ft) separately and shall include centering for spans up to 6 metres (20 ft). For spans exceeding 6 metres

(20 ft) centering shall be measured separately in sq m (sq ft) as the actual area of the soffit to be supported.

**Well steining**—Brickwork in well steining shall be measured in cu m (cu ft) separately stating the mean radius and the total depth of steining. Steel tie rods and flats shall be measured separately in quintal (cwt).

**Sinking of well steining** shall be measured in running metre (r ft) separately in stages of 3 m (10 ft) and shall include all tackles, loading platform loads, dredging or excavation, etc. The rate of sinking for every 3 m (10 ft) is different.

**Well curb** of R.C.C. or timber shall be taken under separate item in cu m (cu ft) and shall be fully described. Steel in R.C.C. or in well curb shall be taken separately in quintal (cwt).

**Honeycomb brickwork**—Honeycomb brickwork shall be taken in sq m (sq ft) stating the thickness of well and the pattern of honey-combing. Honeycomb holes or opening shall not be deducted.

**Partition wall**—Half brick wall or brick-on-edge shall be taken in sq m (sq ft) stating the thickness and shall be fully described including mortar and its proportion. Reinforcement as hoop irons, wire netting or bars if provided shall be included in the items and fully described, stating type, width, gauge or thickness or diameter and spacing.

**Reinforced brickwork**—Reinforced brickwork shall be taken in cu m (cu ft) under separate item the steel reinforcement shall be measured separately in quintal (cwt).

**Brick edging**—Brick edging by the sides of roads, paths and the like shall be described and measured in running metre (r ft).

**Moulding and cornices**—String courses, corbel, drip course, cornices, etc., shall be fully described and measured in running metre (r ft).

**Toothing and bonding**—Toothing and bonding for new and existing walls shall be taken under a separate item, in sq m (sq ft) and measured on the vertical face.

**Brickwork around steel joints**—Extra labour in cutting and fitting brickwork around steel joints, stanchions, girders, etc., shall be measured in sq m (sq ft) the girth of joints, girders, etc., being measured.

## STONE MASONRY

The description of stone, materials or mortar and their proportion and the nature and type of walling shall be stated. Different kind of stone masonry as Random or Uncoursed rubble walling, coursed rubble walling, ashlar walling, etc., shall be taken under separate items.

Stone masonry work shall be taken in cu m (cu ft). The thickness of wall shall be measured to the nearest 1 cm ( $\frac{1}{2}$ "), fractions including 0.5 cm ( $\frac{1}{4}$ ") and above shall be measured as 1 cm ( $\frac{1}{2}$ ") and fractions below 0.5 cm ( $\frac{1}{4}$ ") shall be ignored.

**Rules for deduction**, measurement of an arch work and other items of stone masonry shall be same as for the similar items of brickwork.

**Stone face work** or wall lining shall be described and taken in sq m (sq ft) stating the thickness.

**Stone chujja**, stone shelves, stone sun-shades and stone slabs shall be taken in sq m (sq ft) stating the thickness and described including, dressing, etc.

**Dressed stone work** in sills, steps, columns, copings lintels, etc., shall be taken in cu m (cu ft) and the type of dressing shall be described fully. Each dressed stone shall be measured as the smallest rectangular dressed block from which finished dressed block can be worked. String course, cornices, etc., shall be measured in running metre (r ft) describing details of sections.

**Boulder work** shall be taken in cu m (cu ft) stating the size of boulders. Different kind and nature of boulder work shall be taken under separate item.

#### WOODWORK

**Carpenter's work.**—Generally all woodwork of which the scantling exceeds 20 sq cm (3 sq in) in section and which is not specially moulded or carved comes under carpenter's work. This includes all timber work in door and window chauhats, in roof works as beams, struts, ties, rafters, purlins (all work in roof trusses), in timber bridge in verandah posts, in centering and shuttering, in shoring, and the like.

**Joinery.**—Woodwork which is prepared, turned, moulded, carved and jointed together comes under joinery. Joiner's work requires finishing and putting together at the bench and includes door and window shutters, framed partitions, furnitures and the like.

#### CLASSIFICATION OF TIMBER

(a) **Batten.**—Battens are pieces of sawn timber, whose dimensions do not exceed 5 cm (2") either in breadth or in thickness.

(b) **Scantlings.**—Scantlings are pieces of sawn timber whose cross-sectional dimensions exceed 5 cm (2") in both directions and do not exceed 20 cm (8") in both directions.

(c) **Baulks.**—Baulks are pieces of sawn timber whose cross-sectional dimensions exceed 5 cm (2") in one direction and 20 cm (8") in other direction.

(d) **Planks.**—Planks are pieces of sawn timber whose thickness does not exceed 5 cm (2") and at the same time the width exceeds twice the thickness.

#### CARPENTER'S WORK

Different kind of wood and different nature of woodwork shall be taken under separate item and shall be fully described stating the wood and the work.

Woodwork (carpenter's work) shall be taken in cu m (cu ft). Length shall be measured to the nearest 2 cm (1"). Width and thickness shall be measured to the nearest 2 mm (1/16"). All work shall be measured net as fixed and tolerance of 2 mm (1/16") may be allowed. No allowance shall be made for the sawn or wrought faces for the finished work. Scantlings, battens etc., in sections other than rectangular, shall be measured as the least rectangular form which the section can be obtained. All woodwork shall include nails, screws, spikes etc., required for fixing.

**Boarding.**—Roof boarding, ceiling, floor shelves, partition, etc., shall be taken in sq m (sq ft) stating the finished thickness and shall be fully described. Supporting beams, framework, shall be taken separately in cu m (cu ft).

**Centering and shuttering.**—Normally centering and shuttering (formwork) shall not be measured separately but included in the rate of C.C. or R.C.C. work. If specified that the formwork shall be paid separately the formwork shall be measured and the actual surface in contact with the concrete and taken in sq m (sq ft) and shall include plankings, beams, props, wedges, nails, etc.

Formwork of different kind of works as beams, lintels, floors, roads, walls, columns, staircases, etc., shall be measured under separate items and fully described.

*For slabs, chajjas, arches, shells and domes only the area of bottom shuttering in contact with concrete surface shall be measured and side shuttering shall not be taken into account (C.P.W.D. Specifications).*

**Roof battens.**—Roof battens, where not included with the item of roof, shall be taken as surface area of the roof in sq m (sq ft) stating the size of battens and the spacing.

**Fillets.**—Fillets, beadings, etc., shall be measured in running metre (r ft) stating the width and thickness. Finishing of fillet as edges chamfered, rounded or moulded shall be described.

**Ballies.**—Ballies shall be measured in running metre (r ft) stating the mean diameter which shall be average of the two diameters at the ends.

**Wood piles.**—Wood piles shall be measured in running metre (r ft) stating the size. Steel shoes and heads of piles shall be enumerated separately stating their weights.

Sheet piles shall be measured separately in sq m (sq ft) stating the thickness and shall be described.

Driving and pitching of whole piles shall be taken in running metre (r ft) and of sheet piles in sq m (sq ft) stating the size in each case. Portion in ground only shall be measured.

#### JOINERY

Description and quality and kind of wood shall be stated and joinery of different kind of work shall be taken under separate items.

Joinery work shall be taken in sq m (sq ft) of the surface stating the thickness. All joiner's work shall include nails, screws, keys, wedges, pins, glue, etc., required for fitting and all fittings shall be included in item. Unless work is described as finished sizes, 2 mm (1/16") shall be allowed for each wrought face.

**Door and window shutters.**—Shutter shall be taken in sq m (sq ft) stating the thickness and the kind of wood and both faces shall be described. Measurement shall be taken from inside after closing the shutters excluding chauhats. Different types of shutters as (i) Lugged, and battened, (ii) Lugged, braced and battened, (iii) Framed, lugged, braced and battened, (iv) Framed and panelled, (v) Framed and louvered, (vi) Flush, (vii) Glazed, (viii) Part panelled and part glazed, etc., shall be taken separately and each type fully described.

Thickness of battened leave shall be the thickness of battens only, not the combined thickness of battens and ledges the thickness of ledges and braces shall be stated in the description.

Glazed shutters shall be measured flat over all in sq m (sq ft) including the timber framework, stating the thickness of timber frame and of glass panes. Glazing shall not be measured separately. The method of fixing glass panes as puttied, felted, wooden beading fitted with nail, screws, etc., shall be described and different type of fixing shall be measured under separate item.

Part panelled and part glazed shutters, shall be measured flat over all in sq m (sq ft) and how much glazed as half one-third, etc., shall be stated.

**Glass panes.**—For supply glass shall be measured in sq m (sq ft) stating the thickness and type of glass. Measurement, length and breadth shall be taken to the nearest 5 mm ( $\frac{1}{8}$ "'). Irregular or circular panes shall be measured at the smallest rectangular area from which they can be cut unless otherwise specified.

**Door and window chauhhat.**—Chauhhat mullion and transoms shall be taken in cu m (cu ft) and the length of tenons, horns etc., shall be added to the sight lengths. The sectional area shall be the area of the least square or rectangle from which they may be cut or made. Rebates, beads, chamfers etc., shall be described and included with the item. Portion of chauhhat of segmental or circular shape shall be measured separately and described. Type of wood shall be stated and chauhhat of different kind of wood shall be kept separate.

**Wooden staircase.**—Work of staircases shall be measured under separate headings.

**Landing** including bearers shall be measured under a separate item in sq m (sq ft) of the upper surface, stating the thickness.

**Treads and risers** shall be taken in sq m (sq ft) stating thickness, the area being obtained by multiplying the length of tread by the exposed width of the tread, plus the rise from step to step and the work shall be described stating the kind of timber's method of jointing, fixing, etc.

**Hand rails** shall be taken in running metre (r ft) and measured along the top centre line stating the extreme section of the straight portions and mouldings and rounding.

**Balusters** shall be taken in numbers stating the size and shall include framings at ends shall be fully described.

**Newals** shall be described and measured in running metre (r ft) stating the section and the nature of finishing.

**Miscellaneous items.**—Towel rails, contain brackets, plate racks, toilet fixtures, small fittings, furnitures etc., shall be taken in numbers stating the size and shall be fully described.

**Builder's hardware.**—Builder's hardware is the trade name of the articles made of base metal as iron, steel, copper, etc. The various kinds of builder's hardware shall be described and enumerated and taken separately according to the materials, finish, size and pattern. The following articles come under builder's hardware :—

Hinges, door handles, hasp and staples, locks, hat pegs, hat and coat hooks, wardrobe hooks, knobs, springs, screwed eyes, cleats, latches, bolts and the like.

Curtain rods or poles, curtain rails, for running sashes, etc., shall be measured in running metre stating diameter and size.

**Glazing.**—Glazing shall be measured in sq m (sq ft) stating the quality, weight and thickness. The method of glazing and fixing with putty, wooden beads, metal beads, etc., shall be fully described. Different kind of glass and different methods of fixing each shall be taken separately.

### STEEL AND IRON WORK

In general steel and iron work shall be measured by weight in quantity (cwt) and fully described. Various items of rolled steel sections as joists, channels, angles, tees, mild steel rounds, flats, bolts, cast iron, wrought iron, etc., shall be measured under separate items.

**Structural steel works.**—Structural steel works as girders, compound girders, plate and lattice girders, steel stanchions, trusses, framed steel work, etc., shall each be taken under separate item and measured in quintal (cwt) and fully described. No deduction shall be made for rivet and bolt holes. In riveted work the weight of rivet heads except in case of countersunk rivets, shall be added. The weight of cleats, brackets, packing pieces, separators, gusset and fish plates, bolts and nuts, rivet heads, etc., shall be added to the weight of the respective items. The work shall include fabrication, hoisting, placing, fixing in position.

Site drilling to existing steel work shall be enumerated stating the diameter of bolts and thickness of metal. Rivets driven at site shall be enumerated as 'extra over'

**Bolts.**—Bolts, holding down bolts, anchor bolts, etc., shall be measured in quintal (cwt) separately including nuts and head and washers shall be grouped according to the diameter.

**Grills grating,** framed gaurd bars, ladders, brackets, etc., shall be measured in quintal (cwt) separately and shall be fully described. If specified grills, gratings, etc., may be taken in sq m and fully described.

**Iron hold fasts** shall be taken by weight in quintal (cwt), or enumerated stating the length, breadth and thickness of flat iron. The method of fixing with bolt or screw and embedding in cement concrete or cement mortar shall be described and included in the item.

**Five pipes** shall be measured in running metre (r ft) stating the diameter and the type of pipe, gauge or weight per unit length and the method of jointing and fixing shall be described.

**Cast iron balusters and newals** shall be enumerated and fully described including the methods of fixing.

**Cast iron railings** shall be measured in running metre (r ft) stating the height and fully described including the method of fixing.

**Spiral staircase.**—Cast iron spiral staircase shall be enumerated (*i.e.*, counted as one for the complete work) stating the overall diameter, total number of treads and total height above ground level. The description shall include tread, riser and sleeves in one piece including hand rails, balusters, etc.

**Cast iron chequered plates** shall be described and measured in quintal (cwt).

**Expanded metal, wire netting etc.,** shall be measured in sq m (sq ft) stating gauge and mesh. No deduction shall be made for openings up to 0.2 sq m (2 sq ft). Different items shall be kept separate.

**Steel reinforcement.**—Bar reinforcement shall be measured by weight in quintal (cwt) stating the diameter and shall include cutting to length, hooked ends cranking or bending etc. Authorised overlaps shall be measured. Different diameter bars shall be kept separate.

**Binding wire** shall not be measured separately, this shall be included in the item.

**Fabric reinforcement** shall be taken in sq m (sq ft) stating the mesh and size of strands.

**Wire netting** in wrappings to steel work embedded in concrete or plaster, in encasing steel work shall be measured separately in sq m (sq ft) stating the mesh and gauge.

**Hoop iron** shall be measured in running metre (r ft) stating the width and gauge.

**Wire fencing.**—Plain or barbed wire in fencing shall be measured in running metre (r ft) and shall be described stating the gauge. Each line of wire shall be measured. Fencing posts shall be measured separately.

**Collapsible gates** shall be taken by overall area in sq m (sq ft) or by weight in quintal and fully described stating the size of gate opening, channel pickets, pivoted flat bars, size of mesh when fully extended. The top and bottom runners, locking lugs, handles, etc., shall be described and included in the item. The work shall include erection in position and securing runners with holdfasts or brackets which shall be described.

**Rolling shutters** shall be measured flat in sq m (sq ft) stating the gauge and width of slats, distance between centres of interlock and the bridge depth. The description shall include spring winding mechanism, top cover, jamb guides, bottom rail and locking arrangements including erection and finishing in position.

**Steel doors and windows** shall be taken in sq m (sq ft) stating the sizes of various numbers and shall be described. Hanging, fixing and fastening in position shall be included and described. Manufacturer's protective treatment as galvanizing, painting, etc., shall be described.

**Lightning conductors.**—Conductors and band of tape shall be measured in running metre (r ft) in position after fixing stating width, gauge or thickness, metal, etc. and shall be described, including the method of fixing. Socket attachments and rods shall be enumerated and shall be fully described.

#### ROOF COVERING

**General.**—Roof covering shall generally be taken in sq m (sq ft) and measurements of laid roof shall be taken without any allowance for laps. Opening up to 0.4 sq m (4 sq ft) shall not be described. Supporting structure of the roof shall be taken under separate item. Timber trusses (rafters, ties, purlins, etc.) shall be taken in cu m (cu ft) and steel trusses shall be taken in quintal (cwt).

#### SLOPING ROOF

**Sheet roofing** shall be taken in sq m (sq ft) of the laid work net. The gauge of the metal, whether black or galvanized, plain or corrugated and the methods of fixing including side and end laps shall be described.

**Corrugated sheeting** shall be measured flat not girthed.

**Ridges, hips, valleys flashings, etc.,** shall be measured in running metre (r ft) stating the girth, lap, etc., and shall be described including the method of fixing.

**Asbestos cement sheeting** shall be measured flat and not girthed. The type of sheeting plain, corrugated or semi-corrugated shall be described stating the thickness. When the ridges or hips are in two pieces measurement shall be taken in running metre (r ft) for one length only for the two interlock pieces.

**Roof tiling** shall be taken in sq m (sq ft) of the laid work net stating the kind, pattern, quality, size and thickness of tile numbers of layers, etc., and the method of laying shall be described. If laid in two layers only one surface area shall be measured and number of layers shall be stated. Different kind of tile roof shall be kept separate.

**Ridges and hips** shall be measured in running metre (r ft) stating the girth.

**Eave tiles bedded in mortar or walls** shall be taken in running metre (r ft) as 'extra over' for eaves describing the mortar and width of bedding.

**Slate roof** shall be measured in the same way as for the roof tiling.

**Thatched roof** shall be taken in sq m (sq ft) stating the finishing thickness, kind of straw, number of layers including bamboo jalley (jaffri) work and shall be fully described. The description shall include method of laying, tying string, trimming to eaves and verges, and bamboo jaffri work.

**Ridges and hips** shall be described and taken in running metre (r ft).

**Matting** if provided and included with the roof shall be taken separately in sq m (sq ft) of the laid work net stating the number of layers, laps and the method of fixing. Different kind of matting shall be kept separate.

**Bamboo jaffri or trellis work.**—Independent jaffri work shall be taken separately in sq m (sq ft) and overall surface measurement shall be taken stating the size of bamboo quarter, half or full, their spacings, one way or two way, type of string or wire for tying, etc.

**Framing** shall be included with the item and described.

**Bamboos fixed independently as supports** shall be taken in running metre (r ft) stating the girth.

#### FLAT TERRACED ROOF

**Flat terraced roof** shall be taken in sq m (sq ft) stating the thickness, size and quality of bricks, tiles, or stone slabs. The spacing, number of layers, type of joint, kind of mortar and its mix, pointing, and the method of laying shall be described. The finish on top and underside of roof shall be included with the roofing. Different kind of terraced roof shall be taken as separate items.

**Madras terrace roofing** shall be measured in sq m (sq ft) and shall include top and underside plaster finish and shall be fully described.

**Lime concrete** in roof terracing over R.C.C. slab, jack arches, etc., shall be taken in sq m (sq ft) stating the type and size of aggregate (ballast), mortar and its mix, and the thickness of the consolidated layer. Finishing of the surface shall be described and included with the item. If special surface finishing is required this shall be taken separately in sq m (sq ft) and fully described.

**Stone slab roofing** shall be measured in sq m (sq ft) stating the thickness and centre to centre distance of battens or joists.

**Mud roof**—Mud layer shall be described including the quality of clay and its mix and shall be measured in sq m (sq ft) in the same way as for lime concrete in roof.

**Weep holes or rain water holes** in parapet or in edging shall be enumerated stating the size and finish.

**Water proofing layer** with tar or bitumen shall be taken in sq m (sq ft) stating the quality, type, and quantities of materials to be used per sq m (sq ft).

**Felt work** shall be taken in sq m (sq ft) and shall be described stating the weight per sq m (sq ft), method of application, laps, etc.

**Jack arch roofing.**—Jack arch work including haunch filling concrete shall be measured flat overall, and taken in sq m (sq ft). Centering and shuttering shall be included in the item. The clear span, rise, and thickness of arch, method of laying, jointing, mortar and its mix, and pointing shall be described. The haunch filling, finish of top and underside shall also be stated and included. Lime concrete in terracing over jack arch shall be taken in sq m under a separate item stating the consolidated thickness.



If specified the brickwork in jack arch may be taken in volume basis in cu m, the concrete in haunch filling may be taken in cu m and the plastering in soffit may be taken in sq m each under a separate item.

Lime concrete terracing haunch filling, and top finishing shall be taken separately in sq m (sq ft) in the same way as for terraced roof.

**Rain water fitting.**—Rain water pipe gutter, etc., shall be taken in running metre (r ft) stating the material, diameter or girth, gauge or weight or thickness, etc. All specials as bends, junctions, etc. and fittings and jointings shall be included in the item. Iron brackets for gutters shall be measured separately in quintal.

### CEILING

Ceiling shall be taken in sq m (sq ft) and the materials, thickness and the method of fixing shall be described. No deduction shall be made for opening not exceeding 0.4 sq m (4 sq ft). Different kind of ceiling shall be kept separate.

Cover fillets or beading over joints shall be measured separately in running metre (r ft) stating the materials, width and thickness. If the edges of fillets are chamfered or rounded or moulded, they shall be described.

Supporting member shall be measured separately under the respective items.

Insulation layer, boards or slabs in walls or roof shall be taken in sq m (sq ft) stating the materials, number of layers, thickness of each layer and the manner of fixing.

### FLOORS AND PAVINGS

Floors and pavements shall be taken in sq m (sq ft) and net area covered shall be measured stating the thickness, kind of materials, size, mortar and its mix. The method of bedding, jointing and surface finishing shall be described including the formwork.

Different kind of flooring as brick flat, brick-on-edge stone, marble, cement concrete, mosaic terrazzo, etc., shall be taken under separate item.

The surface finishing of cement concrete floor shall be measured in sq m separately unless otherwise stated and fully described. In practice the surface finishing of cement concrete floor with a floating coat of neat cement is usually included in the item. The rubbing and polishing of mosaic, terrazzo, marble or stone floor are usually included in the item. Pointing of brick floor shall be measured in sq m (sq ft) separately unless otherwise stated.

Under layer of lime concrete, or cement concrete sand, etc., shall be described and measured separately in cu m (cu ft) unless otherwise stated.

**Skirting and dado.**—Skirting up to 30 cm in height shall be measured in running metre (r ft) and skirting or dado exceeding 30 cm shall be measured in sq m (sq ft) stating the type of finish.

### PLASTERING AND POINTING

**Plastering.**—Plastering shall be taken in sq m (sq ft) stating thickness, mortar and its mix. Plastering of all roofs ceiling, walls, etc., shall be measured under separate items. The measurement of all plastering shall be taken for the dimensions before plastering for length and from top to floor or skirting to the ceiling for height. Exterior plastering to a height greater than 10 m (30 ft) from average ground level shall be measured separately in stages of 3 m (10 ft).

Plastering bands 30 cm (12") or below shall be measured in running metre (r ft).

### Deductions—

- No deductions shall be made for ends of joints, beams, posts, etc., and openings not exceeding 0.5 sq m (5 sq ft) each and no addition shall be made for reveals, jambs, soffits, sills, etc., of these openings nor finishing plaster around ends of joints, beams, posts, etc.
- For openings exceeding 0.5 sq m (5 sq ft) but not exceeding 3 sq m (30 sq ft) each deduction shall be made for one face only and the other face shall be allowed for jambs, soffits and sills which shall not be measured.
- When the two faces are plastered with different mortars or if one side is plastered the other pointed, deduction shall be made on the side of chawkhat of door and windows on which the width of jambs or reveals is less than on the side. (Usually, deduction shall be made for the outer face only).
- In case of openings of area above 3 sq m (30 sq ft) each deduction shall be made for both faces of the openings, and the jambs and sills, shall be measured and added. In taking measurement of jambs, soffits and sills, chawkhat if any shall be neglected and the whole shall be measured.

Moulded cornices and coves shall be measured in running metre (r ft) stating the girth and shall be fully described.

**POINTING.**—Pointing shall be taken in sq m (sq ft) and measured flat of the whole surface area stating the type of pointing mortar and its mix. Various types of pointing as, struck flush, keyed, truck, etc., shall be taken separately. Pointing of wall, floor, roof, etc., shall be kept separate. Raking of joints shall be included in the item.

Deductions shall be dealt in the same way as for plastering.

### WHITE WASHING, COLOUR WASHING AND DISTEMPERING

All works falling under this shall be taken in sq m (sq ft). Preparation of surface as cleaning, brooming, scraping, etc., shall be included in the item. The items shall include repairs of surfaces as holes, cracks, patches, etc., not exceeding 0.1 sq m (1 sq ft) with materials similar to existing surface. Different types of works shall be measured separately and described. Deduction shall be dealt in the same way as for plastering.

Finishing coat on corrugated surface shall be measured flat as fixed in sq m (sq ft) and not girthed and the quantities so measured shall be increased by the following percentages and added with the measured area :—

Corrugated iron sheets	14 per cent
Corrugated asbestos cement sheet with large corrugations (as Big six sheets)	20 per cent
Semi-corrugated asbestos cement sheets (as Trafford sheets)	10 per cent

Cornices and mouldings, when these are not taken as separate item, shall be girthed and included in the wall measurement.

### PAINTING

Painting shall be taken in sq m (sq ft) stating the number of coats and measurement shall be taken flat. Preparatory work as cleaning rubbing down, removing, burning off, etc., shall be described. Different types of surfaces as steel, wood, fibre board, concrete surface etc., shall be measured under separate item. Painting in large area as roof ceiling etc., shall be kept separate and painting of small items as doors and windows, steel works, etc., shall each be taken under separate item.

Corrugated surfaces shall be measured flat in sq m (sq ft) and percentage increase similar to white washing, etc., shall be added.

**Doors and windows.**—Painting of doors and windows shall be measured closed and flat not girthed in sq m (sq ft) and shall include chaukhat edges, cleats, etc. Different types of doors and windows as battened, panelled, glazed, etc., shall be grouped under one item and the areas of uneven surfaces shall be covered into equivalent plain area by multiplying the flat measured area by a multiplying factor.

The co-efficients or multiplying factors for different surfaces to get equivalent plain area are as given below :—

Particulars	Method of Measurement	Multiplying Factors
<i>Doors and Windows—</i>		
1. Panelled, framed, and braced, ledged and battened, ledged, battened and braced.	Measured flat not girthed including chaukhat, edges, chocks, cleats, etc., shall be included in the item.	1½ (for each side).
2. Fully glazed or gauged.	Same as above.	½ (for each side).
3. Part panelled and part glazed or gauged	Same as above.	1 (for each side).
4. Flush door	Same as above.	1 (for each side)
5. Flush venetioned or louvered	Same as above.	1½ (for each side).
<i>Miscellaneous works—</i>		
6. Boarding with cover fillets and match boarding.	Measured flat not girthed	1 1/20 (for each side).
7. Roof battens (tile or slate roof).	Measured flat overall, no deduction for open spaces.	¾ (for painting all-over).
8. Trellies or jaffri work one way or two way.	Same as for (6) above. (Supporting members shall not be measured separately).	2 (for painting all-over).
9. Guard bars, balustrates, grating, railings, grills, expanded metal, etc.	Measured flat overall no deduction for open spaces.	1 (for painting all-over)
10. Corrugated iron sheeting in roof.	Measured flat not girthed.	1.14 (for each side).
11. A.C. corrugated sheeting in roof	Measured flat not girthed.	1.20 (for each side).
12. A.C. semi-corrugated sheeting in roof	Measured flat not girthed	1.10 (for each side).
13. Steel rolling shutters.	Measured flat not girthed.	1½ (for each side).

Painting upto 15 cm (6") in width or in girth and not in conjunction with similar work shall be measured in running metre (r ft).

Painting on components of trusses, compound girders, stanchions, latices and similar work shall be taken in sq m (sq ft) and measurement of perimeter and length shall be taken to get the area.

Painting on eaves, gutters, pipes, steel poles, etc., shall be measured in running metre (r ft) stating the size and girth.

Small articles up to 0.1 sq m (1 sq ft) painted surfaces shall be enumerated and described. Painting of furnitures shall be enumerated and fully described.

Coal tarring shall be measured similar to painting.

Varnishing of wood work shall be measured in the same way as for painting.

Painting of letters and figures and similar items shall be enumerated stating height, form and style, namely block italics, etc. Stops, commas, hyphens and the like shall be deemed included in the item.

### SANITARY AND WATER SUPPLY WORKS

All pipes and fittings should be classified according to their types, diameters, jointing and fixing. Pipes of different types and different types of joints shall be taken separately. The diameter shall be the nominal diameter of the internal bore.

Pipes shall be measured in running metre (r ft) net as laid or fixed with overall fittings such as bends, junction, etc., which shall not be measured separately. The length shall be measured along the centre line of the pipes and fittings. Methods of laying and jointing shall be fully described. Testing of pipe line shall be included in the item. Lead caulked joints shall be enumerated separately.

Digging and refilling of trenches, concrete bedding, etc., shall be either measured separately or clubbed with the main item. Usually for small diameter pipes the digging and refilling, timbering if required, concrete bedding, etc., are included with the main item and fully described.

**Fitting and appliances.**—Gullies, syphons, intercepting traps, etc. including concrete bedding and setting in position shall be enumerated stating the size.

Connection of fittings, elbows, bends, tees, connectors unions, diminishing sockets and the like shall be enumerated.

Cutting through walls, floors, etc., and making good shall be included with the item.

Closet pans, urinals, flushing cisterns, lavatory basins, bath tubs, shower rose and other fittings shall be enumerated stating the size and fully described.

Sluice valves, stop cocks, hydrants, surface boxes, water metres, etc., shall be described stating size and enumerated.

Bib-cocks, pillar cocks, ball cocks, ferrules, gratings, etc., shall be described stating the size and enumerated.

Boilers, cisterns, cylinders, water tanks, etc., shall be enumerated stating the size, capacity, materials, etc., and fully described.

**Manholes.**—Manholes up to 6 m (20 ft) depth shall be enumerated stating the size and depth and shall include cast iron cover with frame (weight to be stated) foot iron, inverts, materials and mortar, formwork, etc., all of which shall be fully described.

Manholes shall be classified under three different groups as follows :—

- |                  |                             |                        |
|------------------|-----------------------------|------------------------|
| (i) Shallow      | up to 2.1 m                 | (7') in depth.         |
| (ii) Deep        | above 2.1 m and up to 7.2 m | (7' to 14') in depth.  |
| (iii) Extra deep | above 4.2 m and up to 6.0 m | (14' to 20') in depth. |

Manholes under each classification shall be enumerated separately stating the size and least depth and the extra depth shall be measured in running metre (r ft) and totalled up separately for each classification and taken as 'extra over' under separate item following the main item. Depth shall be from the top of manhole to the invert of channel.

Manholes exceeding 6 m (20') in depth shall be measured in details under the various items of works, brickwork, concrete, C.I. cover with frame, etc.

#### ELECTRICAL WORK

Electrical wiring shall be taken in points as light point, fan point, plug point, etc., and shall be enumerated under different items and fully described.

Wiring in different systems such as Tough rubber sheathed (T.R.S.) on battens. Vulcanized insulated rubber (V.I.R.) in casing or capping. Vulcanized insulated rubber (V.I.R.) in conduit, etc., shall be fully described and taken separately. These shall be further classified according to the size of cables used, number of wires and size in the cable shall be described under each classification.

Point wiring shall include all work necessary in complete wiring of a tumbler switch circuit and length from the tapping point on the distribution circuit to the various points as ceiling rose, lamp holder, back plate, call bell, etc., via the switch. Point wiring shall include switch, ceiling rose, wood and metal blocks, switch boards, battens, clips, nails, screws joint and junction boxes, bulk head fittings, earth wire, etc.

Lamps, brackets, lamp holders, shades, sockets, outlets, fans, regulators, call bells, fuses, main switch boards etc., shall not be included in the point wiring but shall be enumerated separately and fully described.

**Classification.**—Point wiring shall be classified according to the length of wiring as under :—

(a) Short points not exceeding	3 m (10') in length.
(b) Medium points	3 to 9 m (10' to 20') in length.
(c) Long points	6 to 10 m (20' to 30') in length.
(d) Special points of length exceeding 10 m (30').	

**Circuit wiring.**—The length of wiring from the main switch board to the sub-main board shall be considered as circuit wiring and shall be measured separately in running metre (r ft) stating the type and size of wire.

**Service connections.**—Service connection shall be fully described stating the type and size of the wire and shall be measured as follows :—

Insulated cables	in running metre (r ft).
Bare cables	in kg or quintal.

All over-head bare wire or cables shall be measured in kg of the actual length fixed.

**Pole and struts** for over-head links shall be enumerated and described stating the type, sectional size, girth and diameter and the total length.

Steel brackets, cross-arms, clamps, etc., fixed to poles and struts shall be fully described and enumerated under separate item.

Stay assemblies shall be enumerated and fully described including excavation, concrete, etc.

**Earthing poles and service connections** shall be enumerated and fully described as including earth electrode, packing charcoal, earth wire, etc.

#### ROAD WORK

**Road metal collection.**—Road metal, ballast, grit, etc., shall be measured in cu m (cu ft) stating gauge, the type, quantity, etc., and shall be described. Measurement shall be taken in bottomless boxes or 'firmas' or in closely packed stacks on level ground. Road metal of different type of gauge shall be taken separately. Usually road metal is stacked along the road on the side berms and cross-sectional measurement is taken with the help of stacking template of trapezium type and the length of the stacks are measured to get the quantity. Stacking of metal shall be included in the item.

Stacks of kankar shall be 32 cm (13") high and shall be measured as 30 cm (12").

Boulder—deduct 10% for voids.

**Road metal consolidation.**—The same quantity as collected shall be taken as consolidated, in cu m (cu ft) stating the method of consolidation, type and weight of rollers or hand rammers, etc.

**Thickness consolidated thickness**, if required, shall be the minimum thickness of layer after consolidation. **Spread thickness**, before consolidation shall be derived from dividing the quantity collected by the superficial area over which the metal is spread.

**Soling.**—Soling coat of *Brick flat* or *brick-on-edge* shall be taken in sq m (sq ft) of the laid work stating the thickness of layer, number of layers, quality of bricks, etc. The method of laying, filling of joints, blinding of the surface and rolling shall be fully described.

**Boulder or stone soling** shall be taken in cu m (cu ft) of the collected metal. Laying shall be taken as the same quantity as collected stating the thickness of layer, method of laying, blinding, rolling, etc.

**Earthwork.**—Earthwork shall be measured in accordance with the rules and methods described under 'earthwork' at the beginning of this chapter. Trimming and dressing of formations to exact level, camber, gradient, super-elevation, etc., shall be included and described.

**Berms.**—Preparation and repair of side berms shall be measured in km (miles) stating the average filling and width. Both sides shall be included under one linear measurement.

**Preparation of sub-grade or formation** to proper camber shall be measured in sq m (sq ft) and described fully, depth of excavation not exceeding 15 cm (6").

**Sub-bases or light-wearing surfaces** of clinker, cinder, shingle, gravel, moorum, bajri, etc., shall be taken in sq m (sq ft) stating the minimum thickness and describing the method of consolidation.

#### TAR AND BITUMEN ROAD

Tar and bitumen roads in general shall be taken in sq m (sq ft) stating the quality and quantity of binder, stone grit, etc. The method of preparation of surface, mixing, laying, consolidation, etc., shall be included and fully described.

**Surface painting** shall be taken in sq m (sq ft) and the quantity of binder (tar or bitumen) in kg per sq m (lbs per sq ft) and the quantity of stone grit in cu m per sq m (cu ft per sq ft) required on road surface shall be described in the item.

*Premix carpet* shall be taken in sq m (sq ft) and the quality of binder in kg per cu m (lbs per cu ft) of aggregate shall be described in the item and the consolidated thickness stated.

*Grouting* (full grout or semi-grout) shall be taken, in sq m (sq ft) and the quantity of binder in kg per sq m (lbs per sq ft) shall be stated. The consolidation thickness of crust of layer shall also be stated.

*Sacrifying*.—Sacrifying of road shall be taken in sq m (sq ft) stating the depth of sacrificing and the metal and surface.

*Cement concrete road*.—Cement concrete road shall be measured in cu m in accordance with rules stated under concrete in this chapter. Formwork of pavement not exceeding 20 cm (8") in thickness shall be included in the concrete item and described including formwork. For those exceeding 20 cm (8") in thickness the formwork shall be measured separately.

#### DISMANTLING AND DEMOLITION

The term *dismantling* implies carefully taking up or down and removing carefully without damage.

The term *demolition* taking up or down or breaking up without care.

The units and methods of measurement of *dismantling* and *demolition* shall be generally the same as those employed for the construction of the respective item of work. Full description of work including necessary precautions and protections required shall be stated. Parts of work required to be dismantled and those required to be demolished, shall be measured separately. The description shall also include separation and stacking of serviceable materials and disposal of unserviceable materials within 30 m (100'). Thickness of plaster shall be excluded in the measurement of wall.

Dismantling of door and windows shall be enumerated stating their size.

*Repairs*—The units and methods of measurement for repair works shall generally be the same as those employed for the construction of the item of work.

#### MATERIALS

*Bricks and tiles* shall be taken in numbers stating the size and quality under different classification as first class, second class, etc. Bricks are stacked by 1000 in each stack and stacks are numbered and the number of stacks entered in the measurement book.

The following materials shall be taken in cu m (cu ft) and measurement shall be taken in bottomless boxes or 'firmas' or closed packed stacks prepared on level ground, stating the size, gauge, quality, type, etc.

*Sand, surkhi, cinder, bajri, kankar, lime, etc. Brick ballast, brick bats, boulder, stone ballasts, kankar gravel, shingle stone grit, etc.* Different item of materials shall be taken separately.

*White lime or stone lime* slaked or unslaked shall be measured by weight in kg. or quintal (maunds) and described. Slaked lime may also be measured in cu m if specified.

*Cement* shall be measured by weight in 50 kg bag in quintal or tonne. Loose cement in small quantities shall be measured by weight in kg.

*Breaking of stone, brick, etc.*, shall be measured in cu m (cu ft) in bottomless box or stacks as in road metal stating the size and shall include stacking.

*Screening of ballast, grit, sand, etc.* shall be measured by weight in kg or quintal by actual weighing.

Large sizes or sections of steel are measured in length (metre) and weight is calculated in kg or quintal from steel section book by multiplying the weight per metre by the length.

## CHAPTER 15

### VALUATION

**Valuation.**—Valuation is the technique of estimating or determining the fair price or value of a property such as a building, a factory, other engineering structures of various types, land, etc. By valuation the present value of a property is determined. The present value of property may be decided by its selling price, or income or rent it may fetch. The value of property depends on its structure, life, maintenance, location, bank interest, legal control, etc. The value also depends on supply on demand and the purpose for which valuation is required.

*Cost* means original cost of construction of purchase, while *value* means the present value (saleable value) which may be higher or lower than the cost. A building whose cost of construction is Rs. 50,000.00, when put for sale may fetch Rs. 60,000.00 this sale price is the value of the building. Similarly, the value may be less than the original cost.

**Purpose of valuation.**—The main purpose of valuation are as follows:—

(i) *Buying or Selling Property.*—When it is required to buy or to sell a property, its valuation is required.

(ii) *Taxation.*—To assess the tax of a property its valuation is required. Taxes may be Municipal Tax, Wealth Tax, Property Tax, etc., and all the taxes are fixed on the valuation of the property.

(iii) *Rent fixation.*—In order to determine the rent of a property, valuation is required. Rent is usually fixed on certain percentage of the amount of valuation (6% to 10% of the valuation).

(iv) *Security of Loans or Mortgage.*—When loans are taken against the security of the property, its valuation is required.

(v) *Compulsory acquisition.*—Whenever a property is acquired by law compensation is paid to the owner. To determine the amount of compensation valuation of the property is required.

(vi) Valuation of a property is also required for *Insurance, Betterment Charges, Speculations*, etc.

**Gross income.**—Gross income is the total income and includes all receipts from various sources the outgoings and the operational and collection charges are not deducted.

**Net income or Net return.**—This is the saving or the amounts left after deducting all outgoings, operational and collection expenses from the gross income or total receipt.

Net income = Gross income — outgoings.

**Outgoings.**—Outgoings or the expenses which are required to be incurred to maintain the revenue of the building. The various types of outgoings are as follows:—

1. *Taxes.*—These includes Municipal Tax, Property Tax, Wealth Tax, etc., which are to be paid by the owner of the property annually. These taxes are fixed on the basis of 'Annual Rental Value' of the property after deduction for annual repairs, etc.

2. *Repairs.* — The repairs are required to be carried out every year to maintain a property in fit condition. The amount to be spent on repairs depends on the age, construction nature of the building, etc., and usually 10 to 15 per cent of the gross income or gross rent or 1 to 1½ months rent is allowed for repairs. For annual repairs 1% to 1½% of the total cost of construction may also be taken.

3. *Management and Collection charges.* — These include the expenses on Rent Collector, Chaokidar, (watchman) Liftman, Pump attendant, Sweeper, etc. About 5 to 10 per cent of the gross rent may be taken on these account. For small building none of these may be required and there will be no outgoings on these account.

4. *Sinking Fund.* — A certain amount of the gross rent is set aside annually as sinking fund to accumulate the total cost of construction when the life of the building is over. This Annual sinking fund is also taken as outgoings.

5. *Loss of rent.* — The property may not be kept fully occupied in such a case a suitable amount should be deducted from the gross rent under outgoings.

6. *Miscellaneous.* — These include electric charges for running lift, pump, for lighting common places, and similar other charges which are to be borne by the owner.

**Municipal taxes.** — Municipality needs money in order to undertake and maintain public utility services and the same is collected by imposing taxes on the property. The main utility works are roads, drainages, water supply, etc., and the construction and maintenance. The taxes are assessed on some percentage basis on the net income from the property and varies from 10% to 25% of the net income. Usually for small houses the taxes are less and for big houses the taxes are high.

**Scrap value.** — Scrap value is the value of dismantled materials. For a building when the life is over at the end of its utility period the dismantled materials as steel, bricks, timber, etc., will fetch a certain amount which is the scrap value of the building. In the case of machine the scrap value is the value of the metal only or the value of the dismantled parts. The scrap value of a building may be about 10 per cent of its total cost of construction. The cost of dismantling and removal of the rubbish material is deducted from the total receipt from the sale of the useable materials to get the scrap value.

**Salvage value.** — It is the value at the end of the utility period without being dismantled. A machine after the completion of its usual span of life or when it become uneconomic, may be sold and one may purchase the same for use for some other purpose, the sale value of the machine is the salvage value. It does not include the cost of removal, sale, etc.

Normally, the scrap value, or the salvage value of a property or an asset has got some positive figure, but it may also be zero or negative. As for example the scrap value or a R.C.C. structure will be negative, as dismantling and removal will be costly.

**Market value.** — The Market value of a property is the amount which can be obtained at any particular time from the open market if the property is put for sale. The market value will differ from time to time according to demand and supply. The market value also changes from time to time for various miscellaneous reasons such as changes in industry, changes on fashions, means of transport, cost of materials and labour, etc.

**Book value.** — Book value is the amount shown in the account book after allowing necessary depreciations. The book value of a property at a particular year is the original cost minus the amount of depreciation up to the previous year. The book value depends on the amount of depreciation allowed per year and will be gradually reduced year to year and at the end of the utility period of the property the book value will be only scrap value.

**Rateable value.** — Rateable value is the net annual letting value of a property, which is obtained after deducting the amount of yearly repairs from the gross income. Municipal and other taxes are charged at a certain percentage on the rateable value of the property.

**Obsolescence.** — The value of property or structures become less by its becoming out of date in style, in structure in design, etc., and this is termed as Obsolescence. An old dated building with massive walls, arrangements of rooms not suited in present days and for similar reasons, becomes obsolete even if it is maintained in a very good condition, and its value becomes less due to obsolescence. The obsolescence may be due to the reasons such as progress in arts, changes in fashions, changes in planning ideas, new inventions, improvements in design technique, etc. A machine of old design may become obsolete, though it may be in good running condition and its value will be less. Thus, though the property is physically sound, it may become functionally inadequate and its economical return becomes less.

**Annuity.** — Annuity is the annual periodic payments for repayments of the capital amount invested by a party. These annual payments are either paid at the end of the year or at the beginning of the year, usually for a specified number of years.

If the amount of annuity is paid for a definite number of periods or years, it is known as *Annuity certain*. In such cases the amount of annuity will be higher, the lesser the number of the years the higher will be the amount and vice versa to clear up to the whole amount of capital.

If the amount of annuity is paid at the beginning of each period of year and payments continued for definite number of periods, it is known as *Annuity due*.

If the payment of annuity begins at some future date after a number of years, this is known as *Deferred Annuity*.

If the payments of annuity continue for indefinite period, it is known as *Perpetual Annuity*.

Though annuity means annual payment, the amount of annuity may be paid by twelve monthly instalments or quarterly or half-yearly instalments.

**Capital cost.** — Capital cost is the total cost of construction including land, or the original total amount required to possess a property. It is the original cost and does not change, while value of a property is the present cost which may be calculated by methods of valuation.

**Capitalized value.** — The Capitalized value of a property is the amount of a money whose annual interest at the highest prevailing rate of interest will be equal to the net income from the property. To determine the capitalized value of a property it is required to know the net income from the property and the highest prevailing rate of interest.

**Example.** — Capitalized value of a property fetching a net annual rent of Rs. 1,000.00 and the highest rate of interest prevalent being 5% is as follows:—

For Rs. 5.00 interest, capital	Rs. 1,000.00
To get Rs. 1,000.00 interest, capital	$= \frac{100}{5} \times 1,000$
	= Rs. 20,000.00

*In short capitalized value is — Net annual income × Year's purchase.*

For the same net income if the rate of interest is 8% the capitalized value,

$$= 1000 \times \frac{100}{8} = \text{Rs. } 12,500.00$$

Thus higher the rate of interest, the capitalized value of built property goes down, obviously the rent shall have to go up.

**Year's purchase (Y.P.).** — Year's purchase is defined as the capital sum required to be invested in order to receive an annuity of Re. 1.00 at certain rate of interest. For 4% interest per annum, to get Rs. 4.00 it requires Rs. 100.00 to be deposited in a bank. To get Re. 1.00 per year it will be required to deposit  $\frac{1}{4}$  of Rs. 100.00, i.e.,  $\frac{100}{4} = \text{Rs. } 25.00$ .

Thus, year's purchase =  $\frac{100}{\text{Rate of interest}} = \frac{1}{i}$ ,  $i =$  rate of interest in decimal. For 5% interest, Year's purchase =  $\frac{100}{5} = 20$ . For 6% interest, Year's purchase =  $\frac{100}{6} = 16.67$  and so on.

In the case of a property whose period of utility is limited to a number of years a certain amount is required to be set aside in the form of *sinking fund*, to accumulate the amount of original capital cost at the end of the utility period of the property, otherwise the owner of the property will lose both capital and income at the end of the utility period. Hence the Year's purchase will be reduced in such a way that income of the property will provide both for interest on the capital and for accumulation of the sinking fund to replace the capital. In such cases, Year's purchase =  $\frac{1}{i + s}$ , where  $s =$  sinking fund to replace Re. 1.00 at the end of the given period.

**Sinking fund.** — The fund which is gradually accumulated by way of periodic or annual deposit for the replacement of the building or structure at the end of its useful life, is termed as *sinking fund*. The object of creating sinking fund is to accumulate sufficient money to meet the cost of construction or replacement of the building or structure after its utility period. The sinking fund is created by regular annual or periodic deposits in compound interest bearing investment, which will form the amount of replacement at the end of the utility period of the property. The sinking fund may be created by taking a sinking fund policy with an insurance company or by depositing in bank to collect highest compound interest. The calculation of sinking fund depends on the life of the building and scrap value of the building for the cost of old materials. The cost of land is not taken into account in calculating Sinking fund as land remains intact.

The *sinking fund* may also be required for payment of loan. If a property is owned or constructed by taking loan a Sinking fund may be created by setting aside a sum of money annually to accumulate with compound interest in order to repay the debt at the end of the term of loan. The amount thus set aside is also known as Annuity payment. The amount which will be set aside may also be paid directly to lender by way of annual instalment. The amount of annual instalment of the

*Sinking fund* may be found out by the formula,  $I = \frac{Si}{(1+i)^n - 1}$ , where  $S =$  total amount of Sinking

fund to be accumulated,  $n =$  number of years required to accumulate the Sinking fund,  $i =$  rate of interest in decimal (e.g., 5% = 0.05); and  $I =$  annual instalment required.

**Example 1.** — A pumping set with a motor has been installed in a building at a cost of Rs. 2,500.00. Assuming the life of the pump as 15 years, work out the amount of annual instalment of Sinking fund required to be deposited to accumulate the whole amount of 4% compound interest.

$$\text{The annual Sinking fund, } I = \frac{Si}{(1+i)^n - 1} = \frac{2500 \times 0.04}{(1+0.04)^{15} - 1} = 2500 \times 0.05 = \text{Rs. } 125$$

The owner is to deposit Rs. 125/- annually in 4% compound interest carrying investment for 15 years to accumulate Rs. 2,500/-.

**Example 2.** — An old building has been purchased by a person at a cost of Rs. 30,000/- excluding the cost of the land. Calculate the amount of annual Sinking fund at 4% interest assuming the future life of the building as 20 years and the scrap value of the building as 10% of the cost of purchase.

The total amount of Sinking fund to be accumulated at the end of 20 years.

$$S = 30000 \times \frac{90}{100} = \text{Rs. } 27,000.00$$

$$\text{Annual instalment of Sinking fund, } I = \frac{Si}{(1+i)^n - 1} = \frac{27000 \times 0.04}{(1+0.04)^{20} - 1} = 27000 \times 0.0336 = \text{Rs. } 907.20$$

Annual instalment for Sinking fund required for 20 years = Rs. 907.20.

**Depreciation.** — Depreciation is the gradual exhaustion of the usefulness of a property. This may be defined as the decrease or loss in the value of a property due to structural deterioration, use, life wear and tear, decay and obsolescence. The value of a building or structure will be gradually reduced due to its use, life, wear and tear, etc., and a certain percentage of the total cost may be allowed as depreciation to determine its present value. Usually a percentage on depreciation per annum is allowed. The general annual decrease in the value of a property is known as *Annual depreciation*. Usually, the percentage rate of depreciation is less at the beginning and gradually increase during later years.

The amount of depreciation being known, the present value of a property can be calculated after deducting the total amount of depreciation from the original cost.

**Method of calculating depreciation.** — The various methods of calculating depreciation are as follows:—

(1) Straight line method, (2) Constant percentage method, (3) Sinking fund method and (4) Quantity survey method.

In all these methods, it is necessary to decide the economic or effective life of the property.

(1) **Straight line method.** — In this method it is assumed that the property loses its value by the same amount every year. A fixed amount of the original cost is deducted every year, so that at the end of the utility period only the scrap value is left.

$$\text{Annual depreciation } D = \frac{\text{Original cost} - \text{scrap value}}{\text{life in year}} = \frac{C - S}{n}$$

where  $C =$  original cost,  $S =$  scrap value,  $n =$  life of the property in years and  $D =$  annual depreciation. The book value after the number of years, say  $N$  years = original cost —  $N \times D$ .

(2) **Constant percentage method or Declining balance method.** — In this method, it is assumed that the property will lose its value by a constant percentage of its value at the beginning of every year.

$$\text{Annual depreciation, } D = 1 - \left(\frac{S}{C}\right)^{1/n} \text{ where } C, S, n \text{ and } D \text{ have the same meaning as above.}$$

The value of the property of the depreciated cost at the end of the first year, =  $C - DC = C$ .

The value of the property at the end of the second year =  $C_1 - DC_2$  and so on.

The value of the property or the depreciated cost at the end of the  $m$  years =  $C \left( \frac{S}{C} \right)^m$

The formula will fail when  $S = 0$ . When the ratio  $\frac{S}{C}$  is very small, the depreciation for the first year will be considerable.

(3) *Sinking fund method* — In this method the depreciation of property is assumed to be equal to the annual sinking fund plus the interest on the fund for that year, which is supposed to be invested on interest bearing investment. If  $A$  is the annual sinking fund and  $b, c, d$ , etc., represent interest on the Sinking fund for subsequent years, and  $C$  = total original cost, then —

At the end of	Depreciation for the year	Total depreciation	Book value
1st year	$A$	$A$	$C - A$
2nd year	$A + b$	$2A + b$	$C - (2A + b)$
3rd year	$A + c$	$3A + b + c$	$C - (3A + b + c)$
4th year	$A + d$	$4A + b + c + d$	$C - (4A + b + c + d)$
			So on.....

(4) *Quantity survey method* — In this method the property is studied in detail and loss in value due to life, wear and tear, decay, obsolescence, etc., worked out. Each and every step is based on some logical ground without any fixed percentage of the cost of the property. Only experienced valuer can work out the amount of depreciation and present value of a property by this method.

### VALUATION OF BUILDING

Valuation of a building depends on the type of the building, its structure and durability, on the situation, size, shape, frontage, width of roadways, the quality of materials used in the construction and present-day prices of materials. This also depends on the height of the building, height of plinth, thickness of wall, nature of floor, roof, doors, windows, etc. A building located in the market area will have higher value than a similar building in the residential area. Building in the area having sewer, water supply and electricity will have increased value. Building on freehold land will have higher value than building on leasehold land. The value also depends on the demands for purchase which varies from time to time. The valuation of building mainly depends on the income it will fetch if let out. Usually 6% interest per annum of the capital cost is taken as annual rent, it may be more or less according to the prevalent market rate.

The valuation of building is determined on working out its cost of construction at present-day rate and allowing a suitable depreciation. Before valuation the age of the building should be obtained from record if available or by enquiries or from visual inspection and its future life should be ascertained. Present-day cost may be determined by the following method:—

**Cost from record.** — Cost of construction may be determined from the estimate, from the bill of quantities, from record at present-day rate. If the actual cost of construction is known, this may increase or decrease according to the percentage rise or fall in the rates which may be obtained from the P.W.D. schedule of rates.

**Cost from record.** — Cost of construction may be determined from the estimate, from the bill of quantities, from record at present-day rate. If the actual cost of construction is known, this may increase or decrease according to the percentage rise or fall in the rates which may be obtained from the P.W.D. schedule of rates.

**Cost by detailed measurement.** — If record is not available, the cost of construction may be calculated by preparing the bill of quantities of various items of works by detailed measurement at site and taking the rate for each item as prevalent in the locality or as current P.W.D. schedule of rates. All the items of works should be thoroughly scrutinised and their detailed specifications ascertained as actually exist.

**Cost by plinth area basis.** — Determination of cost by detailed measurements and bill of quantities is laborious and lengthy, a simple method is to calculate the cost on plinth area basis. The plinth area of the building as measured and the present-day plinth area rate of similar building in the locality is obtained by enquiries and then cost is calculated. To fix the plinth area rate it's necessary to examine thoroughly the different parts of the building, the foundation, structure, floor, roof, doors and windows, finishing, etc. If judiciously worked out the cost determined by plinth area method will be fairly correct and sufficient for practical purpose. Cost may be calculated by cubical content method. (See Chapter 6).

**Determination of depreciation.** — After deciding the cost of the building or structure by any one of the above method it is necessary to allow a suitable depreciation on the cost. The depreciation depends on the ultimate use of the building, the present age of the building, nature of maintenance, etc. Generally, for the first 5 to 10 years there is little depreciation of the building or structure. The depreciation increases with the life.

For a building whose life is considered as 80 years, if well maintained the following may be reasonable depreciation:—

	Depreciation per year	Total depreciation
0 to 5 years		— = Nil
5 to 10 years	@ 1/2 per cent	— = 2.5 per cent
10 to 20 years	@ 1/4 per cent	— = 7.5 per cent
20 to 40 years	@ 1 per cent	— = 20.0 per cent
40 to 80 years	@ 1 1/2 per cent	— = 60.0 per cent
		Total — 90.0 per cent

The balance 10% represents the net scrap value on dismantling at the end of the utility period.

**Method of valuation.** — The following are the different methods of valuation:—

1. Rental method of valuation. 2. Direct comparisons of the capital value. 3. Valuation based on the profit. 4. Valuation based on the cost. 5. Development method of valuation. 6. Depreciation method of valuation.

1. **Rental method of valuation.** — In this method, the net income by way of rent is found out by deducting all outgoings from the gross rent (See pages 621-622). A suitable rate of interest as prevailing in the market is assumed and year's purchase is calculated. This net income multiplied by Y.P. gives the capitalized value or valuation of the property. This method is applicable only when the rent is known or probable rent is determined by enquiries.

2. **Direct comparison with the capital value.** — This method may be adopted when the rental value is not available from the property concerned, but there are evidences of sale price of properties as a whole. In such cases the capitalized value of the property is fixed by direct comparison with capitalized value of similar property in the locality.

3. **Valuation based on profit.** — This method of valuation is suitable for buildings like hotels, cinemas, theatres, etc. for which the capitalized value depends on the profit. In such cases the net

annual income is worked out after deducting from the gross income all possible working expenses, outgoings, interest on the capital invested, etc. The net profit is multiplied by Y.P. to get the capitalized value. In such cases the valuation may work out to be too high in comparison with the cost of construction.

**4. Valuation based on cost.** — In this method the actual cost incurred in constructing the building or in possessing the property is taken as basis to determine the value of property. In such cases necessary depreciation should be allowed and the points of obsolescence should also be considered.

**5. Development method of valuation.** — This method of valuation is used for the properties which are in the undeveloped stage or partly developed and partly undeveloped stage. If a large piece of land is required to be divided into plots after providing for roads, parks, etc., this method of valuation is to be adopted. In such cases, the probable selling price of the divided plots, the area required for roads, parks, etc., and other expenditures for development should be known.

If a building is required to be renovated by making additions, alterations or improvements, the development method of valuation may be used. The valuation of the property may be worked out from the anticipated future net income which it may fetch after its renovation. The net income multiplied by the Y.P. will give the anticipated capitalized value. The total expenditure required to be incurred in renovation should be worked out, and the original cost of the property together with the new expenditure should be compared with anticipated value and decided if the investment in renovation is justified.

**6. Depreciation method of valuation.** — According to this method of valuation the building should be divided into four parts viz. — (i) Walls, (ii) Roofs, (iii) Floor and (iv) Doors and windows, and the cost of each parts should first be worked out on the present-day rates by detailed measurements. The life of each of the four parts should then be ascertained with the help of table in page 629 (From I, Annexure (B) to Chapter XIII of the Financial Hand Book Volume V, (Part I)

and the depreciated value of each part is ascertained by the formula  $D = P \left( \frac{100 - rd}{100} \right)^n$ , where D is

the depreciated value, P is the cost at present market rate and *rd* the fixed percentage of depreciation (rate of depreciation, *r* stands for rate and *d* for depreciation) and *n* the number of years the building had been constructed. The value of *rd* may be taken as below:—

Structures with 100 years life, *rd* = 1.0; Structures with 75 years life, *rd* = 1.3; Structures with 50 years life, *rd* = 2.0; Structures with 25 years life, *rd* = 4.0; Structure, with 20 years life, *rd* = 5.0.

The values arrived at will be exclusive of cost of land, water supply, electric and sanitary fittings, etc., and will apply to those buildings only which have been properly maintained. If the repairs had been neglected in the past and the present condition is bad or dilapidated, suitable deduction should be made from the values as deducted above, for neglected repairs.

The present value of land and water supply, electric and sanitary fittings, etc., should be added to the valuation of the building to arrive at total valuation of the property.

**Cost of land.** — For the valuation of the whole property the cost of land should also be added to the depreciation value of the building. The cost of land should be taken as prevalent in the locality from the recent sale transactions or from the enquiries from the property Brokers or from the Sub-Registrar's Office.

For Mortgage purposes, the mortgage value of a property is taken as 1/2 to 2/3 of the valuation or capitalized value.

*Life of various items of works in building —*

Details of items and works	Life of the works
<b>Masonry —</b>	
1. Brickwork in lime or cement, Boulder masonry in lime or cement, Cut stone work in lime or cement	— 100 years and above
2. Brickwork in clay, Coursed rubble in mud	— 100 years.
3. Brick arches in lime or cement mortar, Rubble stone arches in lime or cement mortar	— 100 years.
4. Sundried brickwork in clay	— 75 years.
<b>Flooring —</b>	
5. Brick-on-edge or flat flooring over 7.5 cm L.C.	— 40 years.
6. Cement concrete floor, Granolithic floor, stone flooring	— 50 years.
7. Terraced floor or lime concrete	— 20 years.
<b>Roofing —</b>	
8. R.C.C., R.B., Terraced roofing over stone flags, Jack arch Roofing with L.C. terracing	— 75 years.
9. Iron work in roofing	— 80 years.
10. Sal wood work in roof	— 60 years.
11. Country wood in work	— 15 years.
12. Allahabad lock tiling	— 25 years.
13. G.I. Sheet roofing of 22 B.W.G. sheet	— 50 years.
14. Sal ballies in roof	— 20 years.
15. Pine wood ceiling	— 30 years.
<b>Doors and windows —</b>	
16. Teak wood doors and windows, Sal wood doors and windows	— 40 years.
17. Country wood doors and windows	— 30 years.
<b>Iron work —</b>	
18. Rolled steel joist	— 75 years.
19. Wrought iron work	— 80 years.

**Valuation Tables.** — In order to save time and labour and to reduce chances of error in mathematical calculations valuation tables have been prepared which may be used as ready reckoner. Miram's valuation tables are generally used.

**Example 3.** — A property fetches a net annual income of Rs. 900.00 deducting all outgoings. Work out the capitalized value of the property if the rate of interest is 6% per annum.

$$\text{Year's purchase} = \frac{100}{6} = 16.67$$

$$\text{Capitalized value of the property} = \text{Net income} \times \text{Y.P.} = 900 \times 16.67 = \text{Rs. } 15003.00.$$

**Example 4.** — A three-storied building is standing on a plot of land measuring 800 sq m. The plinth area of each storied is 400 sq m. The building is of R.C.C. framed structure and the future life may be taken as 70 years. The building fetches a gross rent of Rs. 1500.00 per month. Work out the capitalized value of the property on the basis of 6% net yield. For sinking fund 3% compound



interest may be assumed. Cost of land may be taken Rs. 40.00 per sq m. Other data required may be assumed suitably.

Gross income per year =  $1500 \times 12 = \text{Rs. } 18,000.00$ .

Outgoings per annum assuming suitable data :-

(i) Repairs at 1/12 of gross income	—	= Rs. 1500.00
(ii) Municipal tax 20% of gross rent	—	= $18000 \times \frac{20}{100} = \text{Rs. } 3600.00$
(iii) Property tax 5% of gross rent	—	= $18000 \times \frac{5}{100} = \text{Rs. } 900.00$
(iv) Insurance premium @ 1/2% of gross rent	—	= $18000 \times \frac{5}{100} = \text{Rs. } 90.00$
(v) Management charges @ 6% of gross rent	—	= $18000 \times \frac{6}{100} = \text{Rs. } 1080.00$
(vi) Other miscellaneous charges @ 2% of the gross rent	—	= $18000 \times \frac{2}{100} = \text{Rs. } 360.00$
(vii) Sinking fund required to accumulate the cost of the building (which is at the rate of Rs. 150.00 per sq m of plinth area = $400 \times 3 \times 150 = \text{Rs. } 180000.00$ ) in 72 years @ 3% interest	—	= $180000 \times 0.0043 = \text{Rs. } 774.00$

Total of outgoings per annum = Rs. 8304.00

Net annual return =  $18000 - 8304.00 = \text{Rs. } 9696.00$

Capitalized value of the building = Net income  $\times$  Y.P. =  $9696 \times \frac{100}{6} = \text{Rs. } 1,61,600.00$

Cost of land @ Rs. 40.00 per sq m =  $800 \times 40 = \text{Rs. } 32,000.00$

Total ... = Rs. 1,93,600.00

The total value of the whole property is equal to Rs. 1,93,600.00.

**Example 5.**— A coloniser intends to purchase a land of 100,000 sq m area located in the suburb of a big city to develop it into plots of 700 sq m each after providing necessary roads and parks and other amenities. The current sale price of small plots in the neighbourhood is Rs. 30.00 per sq m. The coloniser wants a net profit of 20%. Work out the maximum price of the land at which the coloniser may purchase the land.

Total area of land	—	= 100,000 sq m
Deduct 30% for roads, parks, etc.	—	= 30,000 sq m
Net area for plots	...	= 70,000 sq m

Number of plots at 700 sq m per plot =  $\frac{70000}{700} = 100$ .

Selling price per plot @ Rs. 30.00 per sq m =  $700 \times 30 = \text{Rs. } 21,000.00$ .

Total price from sale of all plots =  $21000 \times 100 = \text{Rs. } 21,00,000.00$ .

#### Deduct Expenses

(1) Cost of improving of land levelling and dressing @ Rs. 0.25 per sq m = $100000 \times .25$	—	= Rs. 25000.00
(2) Cost of providing metalled roads drainage, water supply and electrification @ Rs. 3.00 per sq m of whole land = $100000 \times 3$	—	= Rs. 300000.00
(3) Engineer's and Architect's fees for surveying planning, sub-dividing and supervising @ 3% on the sale price = $\text{Rs. } 2100000 \times \frac{3}{100}$	—	= Rs. 63000.00
(4) Other miscellaneous expenses @ 1% on the price = $\text{Rs. } 2100000 \times \frac{1}{100}$	—	= Rs. 21000.00
(5) Coloniser's profit @ 20% on the sale price = $2100000 \times \frac{20}{100}$	—	= Rs. 420000.00

Total expenditure = Rs. 8,29,000.00

Maximum price of land in the undeveloped stage =  $2100000 - 829000 = \text{Rs. } 1,271,000.00$

Maximum rate of purchase =  $\frac{1271000}{100000} = \text{Rs. } 12.71$  per sq m

The coloniser may purchase the whole land @ Rs. 12.71 per sq m for a total amount of Rs. 12.71 lakhs.

**Example 6.**— A building is situated by the side of a main road of Lucknow city on a land of 500 sq m. The built up portion is 20 m  $\times$  15 m.

The building is first class type and provided with water supply, sanitary and electric fittings, and the age of the building is 30 years. Work out the valuation of the property.

Plinth area of the building =  $20 \times 15 = 300$  sq m.

Assuming the plinth area rate as Rs. 200.00 per sq m including water supply, sanitary and electric fittings, the cost of building =  $300 \times 200 = \text{Rs. } 60,000.00$ .

Considering the life of the building as 100 years, the depreciated value of the building:

$$D = P \left( \frac{100 - rd}{100} \right)^n, \text{ where } P = 60000.00, n = 30 \text{ and } rd = 1.0.$$

$$= 60000 \left( \frac{100 - 1}{100} \right)^{30} = 60000 \left( \frac{99}{100} \right)^{30} = 44,280.00.$$

The cost of land assuming Rs. 60.00 per sq m =  $500 \times 60 = \text{Rs. } 30,000.00$ .

$\therefore$  Total valuation of property =  $44280.00 + 30000.00 = 74,280.00$ .

#### MORTGAGE LEASE

**Mortgage.**— An owner can borrow money against the security of his property, and for that purpose he is required to grant an interest to the party advancing the loan. The loan is required to be returned in specified time. The person who takes the loans is known as *Mortgagor*, and the person who advances the loan is known as *Mortgagee*, and the relevant document for the mortgage

transaction is known as *Mortgage deed*. When the loan is fully repaid together with interest the mortgagor has got the right to free his property from the mortgagee, and this is known as *Equity of redemption*.

The amount of loan will depend on the valuation of the property, usually 50 to 70 per cent of the valuation is advanced as loan. The interest should be paid by regular instalments, and the loan also may be repaid by regular instalments spread over the specified period of the mortgage. If the mortgagor fails to pay the instalment of loan as per condition of the mortgage deed, the mortgagee can take over possession of the property and sell it to recover the amount of loan, the interest and other expenses. The surplus, if any, is paid to the mortgagor.

**Freehold property.** — A *freehold property* means that the owner is in absolute possession of the property, and the owner can utilize the same in any manner, he likes, subject to the rules and regulations of Government and local authorities. He may use the property by himself, he may grant leases, or tenancies for a short period or any period.

**Leasehold property.** — It indicates the physical possession of the property and the use of it may be allowed by the original owner (lessor) as per lease document. The owner of a freehold property may give permission to any other person to use his freehold which is known as giving property on lease. The person who takes lease is known as *lessee* or *leaseholder* and the owner who grants lease is known as *lessor*.

The main types of lease are:—

- (1) Building lease (2) Occupation lease.

1. **Building lease.** — The owner of a freehold land leases out his plot of land to somebody to construct a building, on payment of a yearly ground rent by the leaseholder. The leaseholder constructs the building and maintains it at his own expenses and earns some rent from the building. The net income to the leaseholder will be net rent minus the ground rent he pays to the lessor. As the leaseholder has to invest sufficient money in constructing the building, such lease is granted for long period for 99 or 999 years. At the end of the lease period the lessor has got the right on his land together with the structure on the land.

2. **Occupation lease.** — In this case the building or the structure is built by the owner (freeholder) and the built up property is given on lease for the purpose of occupation for a specified period on payment of certain amount of annual rent. The occupational lease may be for residential, office, factory, shop, etc. The lease period will depend on the purpose for which the structure or building has been constructed. If for a factory, the lease period should be 10 to 30 years, for other cases it may be less. In occupation lease the maintenance of the building or structure is usually done by the leaseholder which may be provided in the lease deed.

**Easement.** — Easement are the rights and privileges which one owner of a property enjoys through or over the property of another. The person who enjoys the easements over a property is called *Dominant owner* and the owner over whose property the easements are enjoyed is called a *Servient owner*. The following are some of the main easements:—

- (1) Right to use light and air from and over the property of the adjoining owner's land.
- (2) Right of access from the adjoining owner's land.
- (3) Right to run and maintain water and drainage pipes through the neighbour's land.

- (4) Right of flow of rain water over other's land.
- (5) Right of support for a building from the adjoining owner's land.

The easement rights may be acquired due to continuous and uninterrupted enjoyment for a period of 20 years, or easement rights may be granted by document.

#### FIXATION OF RENT

The rent of building is fixed on the basis of certain percentage of annual interest on the capital cost and all possible annual expenditures on outgoings. The capital cost includes the cost of construction of the building, the cost of sanitary and water supply work and the cost of electric installations and the cost of subsequent additions and alterations if any. The cost of construction also includes the expenditures on the following:—

- (1) Raising, levelling and dressing sites, (2) Construction of compound walls, fences and gates, (3) Storm water drains, and (4) Approach roads and other roads within the compound.

Allowing a certain prevalent percentage of interest on the capital, the return may be worked out. The capital cost divided by the Year's purchase will give the return. If the capital cost is not known, this may be worked out by any method of valuation. The owner expects about 2 per cent higher interest than the prevalent interest to cover up the risk of his investment.

To this net return, all possible expenditures on outgoings are added to get gross annual rent. (For outgoing see pages 621-622).

Gross rent = Net rent + outgoings.

Dividing the gross rent by 12, rent per month can be calculated. The rent worked out by this procedure is known as *Standard rent*, while the actual rent of the property, may be higher or lower than this rent depending upon the situation of the property, type of construction, demand and supply, etc.

In present day an interest of 12 per cent may be a reasonable one for investment on building, but government allows only 6 per cent interest.

**Example 1.** — A building costing Rs. 7,00,000.00 has been constructed on a freehold land measuring 100 sq m recently in a big city. Prevailing rate of land in the neighbourhood is Rs. 150.00 per sq m. Determine the net rent of the property, if the expenditure on an outgoing including sinking fund is Rs. 24,000.00 per annum. Work out also the gross rent of the property per month.

Cost of construction	—	Rs. 7,00,000.00
Cost of land @ Rs. 150.00 per sq m = 100 × 150	—	Rs. 1,50,000.00
<b>Net return:</b>		
On building @ 6% on the cost of construction = $7,00,000.00 \times \frac{6}{100}$		= Rs. 42,000.00
On the land @ 4% on the cost of land = $1,50,000.00 \times \frac{4}{100}$		= Rs. 6,000.00
<b>Total net rent per year =</b>		<b>Rs. 48,000.00</b>

$$\begin{aligned} \text{Gross rent} &= \text{Net rent} + \text{outgoings} && = 48,000 + 24,000.00 = 72,000.00 \\ &&& \text{Per annum} \\ \text{Gross rent per month} &&& = \frac{72,000}{12} = 6,000.00 \end{aligned}$$

**Example 2.**— In a plot of land costing Rs. 20,000.00 a building has been newly constructed at a total cost of Rs. 80,000.00 including sanitary and water supply works, electrical installation, etc. The building consists of four flats for four tenants. The owner expects 8 per cent return on the cost of construction and 5 per cent return on the cost of land. Calculate the standard rent for each flat of the building assuming:—

- (i) The life of the building as 60 years, and sinking fund will be created on 4% interest basis.
- (ii) Annual repairs cost at 1% of the cost of construction.
- (iii) Other outgoings including taxes at 30% of the net return on the building.

$$\begin{aligned} \text{Net return required on land per annum} &= 20,000 \times \frac{5}{100} = \text{Rs. } 1,000.00 \\ \text{Net return required on building per annum} &= 80,000 \times \frac{8}{100} = \text{Rs. } 6,400.00 \\ \text{Total net return per annum} &= \text{Rs. } 7,400.00 \end{aligned}$$

Expenditure on outgoings per annum:—

$$\begin{aligned} (1) \text{ Annual repair @ 1\% on cost of building} &= 80,000 \times \frac{1}{100} = \text{Rs. } 800.00 \\ (2) \text{ Sinking fund at 4\% for 60 years, on 90\% of building cost} \\ &= 80,000 \times 90\% \times 0.42\% = 80,000 \times \frac{90}{100} \times \frac{42}{100} = \text{Rs. } 302.40 \end{aligned}$$

0.42% being the amount of sinking fund per annum of Rs. 100.

$$(3) \text{ Other outgoings at 30\% of net return on building.} = 6,400 \times \frac{30}{100} = \text{Rs. } 1,920.00$$

$$\text{Total of expenditure on outgoing per annum} = \text{Rs. } 3,022.40$$

$$\text{Gross rent} = \text{Net return} + \text{outgoings} = 7,400 + 3,022.40 = \text{Rs. } 10,422.40 \text{ per annum.}$$

$$\text{Standard rent per month} = \frac{10,422.40}{12} = \text{Rs. } 868.53.$$

$$\text{Standard rent per flat per month} = \frac{868.53}{4} = \text{Rs. } 217.13$$

#### VALUATION AND RENT FIXATION OF GOVERNMENT BUILDING

**Valuation.**— The valuation of a building is taken as the total capital cost of construction of the building including water supply, sanitary, electric and fittings. If the cost of construction is not known and cannot be ascertained from record the cost may be calculated by any of the following methods:—

- (i) Detailed measurement of different items of works, (ii) Plinth area basis, (iii) Depreciation methods of valuation by dividing the building into four parts as Walls, Roofs, Floors and Doors and Windows. The methods have already been explained in pages 626-629.

Sometimes the valuation of private building is ascertained on its face value, taken as 200 times the rent per month of the building. And on these values depreciation is allowed depending on the life of the building by the formula  $D = P \left( \frac{100 - rd}{100} \right)^n$  (See pages 628 and Example 6, page 631).

**Rent Statement.**— For every Government residential building the rent, the occupant has to pay, is normally calculated on a statement known as the *Rent Statement*. The rent statement is prepared under the following conditions.

- (i) When a residential building is newly constructed, (ii) When a residential building is acquired by purchase, lease, or transfer, (iii) When there are additions and alterations to a residential building, costing beyond certain limit fixed by the Government, (iv) When whole or part of a building or other non-residential building is to be used for residential purposes.

The rent is reassessed normally every fifth year even though there is no additions and alterations to the building. Further, if there is any additions and alterations to the building, costing more than the limit fixed by the Government concerned, the rent is reassessed which is known as *Revised Rent Statement*. In U.P. the limit for additions and alterations is Rs. 500.00 or 1% of the capital cost, whichever is less. (For Union Government buildings the limit for the cost of additions and alterations is 5% of the capital cost. For minor additions and alterations costing less than the limit fixed, no revision of *Rent Statement* is required.

#### FIXATION AND CALCULATION OF RENT OF GOVERNMENT BUILDING

The basis for calculation of standard rent is to allow a certain percentage of interest on the capital cost and to add the annual expenditure on repairs, maintenance and taxes. The capital cost includes the construction of the building, the cost of sanitary and water supply works, and the cost of electric installations, etc. The cost of land is not included in the capital cost. The standard rent is fixed as per rules framed by the Government, which differs to some extent from State to State.

In U.P. the standard rent is calculated by the following two methods and the lesser amount is taken as the standard rent—

**Method 1.**— According to this method the annual standard rent is taken as 6% per annum of the total capital cost. The capital cost includes the cost of construction of the building, the cost of sanitary and water supply works, and the cost of electric installations. The cost of construction of compound walls, fencing and gates and the cost of approach roads, and other roads within the boundaries are also considered as part of the capital cost. The cost of land is not included.

**Method 2.**— According to this method the standard rent is calculated as 6% interest on the capital cost and in addition the expenditure on annual and special maintenance and repairs, and municipal and other taxes are added. For annual repairs 1½% of the cost of building, 1% of water supply works, 1% of the cost of sanitary works, and 1½% of the cost of electric installations are allowed per annum.

For quadrennial and special repairs 0.6% of the cost of building, 3½% of the cost of water supply works, 3½% of the cost of sanitary works and 3½% of the cost of electric installations are allowed per annum.

Municipal and property taxes are taken as actual amount to be paid, or calculated on the percentage basis of rent as per rules of Municipal Board or Government.

Rent fixed by the above method is the maximum rent or standard rent for building, but the Government official occupying a Government building has to pay 1/10 of salary or emoluments, in

addition he has to pay the water tax, normal as well as excess sewerage charges and Electricity bill, House tax, maintenance cost property tax paid by Government or owner. For Government residential building, a rent statement is usually prepared during the preparation of the estimate and enclosed with the estimate.

For Government residential building constructed before July 1921 an interest of 3½% is allowed instead of 6% for fixing standard rent.

When a portion of a building is occupied for residence and the remaining part is used for office or for other purpose, the rent of the residential portion is calculated proportionately on the areas occupied.

If  $a$  = total plinth area of the building,  $b$  = plinth area of portion used for non-residential purposes from centres to centres of walls and  $c$  = plinth area of the portion of verandahs directly in front of the non-residential portion and used for non-residential purpose then  $b + c$  = plinth area of non-residential portion. Proportionate rent of the residential portion = standard rent of whole building  $\times \frac{a - (b+c)}{a}$

**Example 3.** Calculate the standard rent of a Government residential building newly constructed from the following data—

- Cost of land Rs. 10,000.00.
- Cost of construction of the building—Rs. 40,000.00.
- Cost of roads within the compound, and fencing—Rs. 20,00.00.
- Cost of electric installation including fans—8% of the cost of building.
- Cost of electric installation including fans—10% of the cost of building.
- Municipal House tax—Rs. 400.00 per annum.
- Water tax—Rs. 250.00 per annum.
- Property tax—Rs. 140.00 per annum.

Total capital cost—		
Cost of building	—	= Rs. 40,000.00
Cost of roads and fencing	—	= Rs. 2,000.00
Cost of sanitary and water supply works	$= 40,000 \times \frac{8}{100}$	= Rs. 3,200.00
Cost of electric installation	$= 40,000 \times \frac{10}{100}$	= Rs. 4,000.00
	Total—	= Rs. 49,200.00

Note—Cost of land has not been added to the capital cost—

$$\text{Standard rent @ 6\% interest on capital cost} = 49,200 \times \frac{6}{100} = \text{Rs. 2,952.00 per annum}$$

Method 1—

$$\text{Interest on total capital cost @ 6\%} = 42,200 \times \frac{6}{100} = \text{Rs. 2,952.00}$$

Annual Repairs—

$$\text{Building and roads @ 1.5\%} = 42,000 \times \frac{1.5}{100} = \text{Rs. 630.00}$$

(Contd.)

Sanitary and water supply works @ 1%	$= 3,200 \times \frac{1}{100}$	= Rs. 32.00
Electric installation @ 1.5%	$= 4,000 \times \frac{1.5}{100}$	= Rs. 60.00
Special Repairs—		
Building and roads @ 0.6%	$= 42,000 \times \frac{0.6}{100}$	= Rs. 252.00
Sanitary and water supply works @ 3.5%	$= 3,200 \times \frac{3.5}{100}$	= Rs. 112.00
Electric installations @ 3.5%	$= 4,000 \times \frac{3.5}{100}$	= Rs. 140.00
Municipal House tax		= Rs. 400.00
Government Property tax		= Rs. 140.00
Total standard rent		= Rs. 4,718.00 per annum

Water tax has not been added as this will be paid by the occupant.

The lower between the above two will be the standard rent. Therefore, the standard rent of the building per annum = 2,952.00.

$$\text{The standard rent per month} = \frac{2,952.00}{12} = \text{Rs. 246.00}$$

It will be noticed that for buildings constructed after 1922, the method 1 will always give the standard rent.

#### PLINTH AREA REQUIRED FOR RESIDENTIAL BUILDINGS

Government residential buildings are planned according to the salary of the official for whom the building is meant. Normally, Government officials pay a rent of 1/10 of their salary, therefore, the capital investment should be on the basis of this rent, considering the rental value as 6% on the capital cost. But due to the tremendous increase in the cost of construction the capital cost may be fixed at 100% to 150% higher.

**Example 4—** Find the plinth area required for the residential accommodation for an Assistant Engineer in the pay scale of Rs. 400.00 to 1,000.00 per month.

$$\text{Average pay} = \frac{400 + 1000}{2} = \text{Rs. 700.00 per month.}$$

$$\text{Average monthly rent @ 10\% of salary} = \frac{700.00}{10} = \text{Rs. 70.00}$$

$$\text{Average annual rent} = 70.00 \times 12 = \text{Rs. 840.00}$$

$$\text{Capital cost of the building @ 6\% interest} = \frac{840 \times 100}{6} = \text{Rs. 14,000.00}$$

$$\text{Plinth area required @ Rs. 150.00 per sq m of plinth area} = \frac{14,000}{150} = 93.33 \text{ sq m.}$$

Normally the quarters for the Assistant Engineer should be constructed at the cost of Rs. 14,000.00 having plinth area of 93.33 sq m.

But due to the increase in the cost of construction, this may be increased by 100% and the capital cost of construction may be fixed as Rs. 28,000.00 and the approximate plinth area of 93.33.

## REPORTS, TECHNICAL AND DESIGN DATA

Each estimate is accompanied with a report describing the various features of the work. The report should be written in such a manner that on the study of the report one can form an idea about the whole work. Various points regarding report are given in Chapter 6, page 275. A few typical reports and estimate for different works are given below to form a general idea. The report of each work will differ from the other and shall have to be written according to the nature of the work. The report is usually given at the beginning of the estimate followed by calculations, design, general and detailed specifications, analysis of rates, materials statement and then the detailed estimate. The plans and drawings are enclosed at the end. In the last page of the abstract of estimate there are space for signatures for the Assistance Engineer, the Executive Engineer and the Superintending Engineer and for the sanctioning authority. In the top of title page, the estimate number, name of work, name of division, head of accounts, total cost of the estimate, etc., are written. In index page the contents and page numbers are also given.

### REPORT ON ESTIMATES FOR THE CONSTRUCTION OF RESIDENTIAL BUILDING

The detailed estimate for construction of a residential building for the Executive Engineer at Udaynagar has been prepared in compliance of S.E.'s letter no. .... dated ..... There is no building for the residence of the Executive Engineer at Udaynagar and he has to live in a tented building with meagre accommodation at a very high rent. It has, therefore, been proposed to construct a residential building for the Executive Engineer. The head of the accounts will be 50 civil original works, building.

The estimate provides for the following accommodation :-

One drawing room, one dining room, three bed rooms, one guest room, and the necessary store, kitchen, baths, front and back verandahs and motor garage per plan enclosed.

A site has already been selected having a land of 60 m × 30 m (200 × 100') for the construction of the building having good soil and proper drainage and this much of land has to be acquired. The building shall be oriented to face north direction.

The building shall have lime concrete foundation and first class brick masonry with lime mortar up to plinth level and the superstructure shall be of first class brickwork in cement mortar, 1 : 6. Lintels shall be of R.B. work and roof shall be R.C.C. with lime concrete terrace finishing. The drawing and dining rooms shall have mosaic floor and other rooms 2.5 cm (1") c.c. floor over 7.5 cm (3") lime concrete. Inside and outside walls shall be 12 mm (½") cement lime plastered 1 : 1 : 6, and ceiling shall be 6 mm (¼") cement plastered 1 : 3. Inside of drawing and dining rooms shall be colour washed and inside of remaining rooms shall be white washed and outside wall shall be colour washed. Doors and windows shall be of 4.5 cm (1½") thick teak wood with chankhat of sal wood and enamel painted. All work shall be strictly as per detailed P.W.D. specification.

The estimate has been prepared at P.W.D. Schedule of rates, and for non-schedule items on analysis of rates. The foundation has been designed for a safe load of 9 tonne per sq m (8 ton per sq ft) and the R.C.C. roof has been designed for a safe load of 150 kg per sq m (30 lbs per sq ft) with 1400 kg per sq cm (20000 lbs per sq in) as safe tensile stress of steel and 50 kg per sq cm (750 lbs per sq

in) as safe compressive stress of concrete. All designs and calculations have been included in the estimate. Plans and drawings and site plans are also enclosed with the estimate.

Provision has been made for electrification and sanitary and water supply works and 20% of the estimated cost of the building works has been included for these works. As there is no sewer line in the area a septic tank shall have to be constructed for which lump sum provision of Rs. 700.00 has been made in the estimate.

Provision for compound with a gate in the front and barbed wire fencing on the sides and back and approach road have also been made in the estimate.

A statement of important materials as cement, steel, coal, etc., which shall have to be arranged by the department is also enclosed with the estimate. A rent statement is also enclosed.

The work shall be carried on contract by inviting tenders. The work shall be completed within six months from the date of start.

The estimate work out as Rs. 5,000.00 and is submitted for sanction and allotment of fund.

### REPORT ON ESTIMATE FOR CONSTRUCTION OF A CULVERT

The estimate has been prepared for the construction of an arch culvert of 3 m span in 15 km-300 m on Lucknow-Daulatpur road. The road at this point is flooded almost every year during the rainy season, causing flood and damages in the area. During the last inspection the Executive Engineer has asked to prepare an estimate and this estimate has been prepared in compliance of E.E.'s letter no. .... dated ..... the cost of construction will be met from 50 civil work special repairs.

The culvert has been designed for L.R.A. Class A Loading. The catchment area has been determined from the 2.5 cm (1") map of the area, which comes to 1200 acres, and the water way has been calculated by the Talbot formula  $a = cA^{\frac{1}{2}}$ , where  $a$  = waterway in sq ft,  $A$  = Catchment area in acres, and  $c$  = constant and has been taken as 0.2. All calculation and design have been enclosed with the estimate.

The soil has been tested and has been found to be good, and ordinary spread foundation will be sufficient. The foundation shall be of cement concrete 1 : 4 : 8 and abutments, wing walls and parapets shall be of brick masonry in 1 : 5 cement mortar, the arch work shall be of brick masonry in 1 : 3 cement mortar. Exposed surfaces shall be cement pointed 1 : 2. All works shall be as per detailed P.W.D. Specifications.

The estimate has been prepared at P.W.D. Schedule of Rates. A statement of materials, cement, bricks, coal, etc., required for the construction, has been enclosed with the estimate. The work shall be executed on contract by inviting tenders and the work shall be started after the rainy season and shall be completed within four month's time.

The estimate amounting to Rs. 15,000.00 is submitted for sanction and allotment of Fund.

### REPORT ON THE ESTIMATE FOR A ROAD CONSTRUCTION

The estimate for the construction of Hindnagar-Kaliganj road of 25 km-500 m in length has been prepared for linking Kaliganj with the District Headquarters, in compliance with S.E.'s letter no. .... dated .....

Kaliganj is an important market place for agricultural products and there are some cottage industries in the area, and there having no road the area is not being developed. The proposed road will also serve many villages on either side. The people of the locality have also represented and demanded separately for the construction of this road. It is therefore essential to construct this road. The proposal has been included in the Fourth Five Year Plan and the cost will be met from the Road Development Fund.

Alignment of the road follows an existing cart road with straightening when necessary and avoiding congested areas as far as possible. Flat curves have been provided with a minimum radius of 150 m. In selecting the alignment the principles of shortest route, serving maximum population, minimum drainage crossing easy gradient economy of construction, etc., have been followed. The road passes mostly through uncultivated area in plane land, and mostly in banking of 60 cm to 90 cm high excepting a few places where the road passes in low land where high banking will be required.

Plane table survey has been made for the whole length of the road for 60 m width on each side of the centre line and L-section has been prepared by taking levels at every 30 m and cross levels have been taken at every 90 metre. Formation line has been fixed to have easy gradient and ruling gradient of 1 in 40 has not been reached anywhere. Highest flood level has been kept in view and formation line has been kept above normal flood level.

A number of culverts will be required along the length of the road and a bridge of about 30 m span will be required across the stream in km 12. A list of bridges and culverts of different span has been enclosed and provisions have been made on the basis of running metre of span at the rate of Rs. 5,000.00 per r m of span for culverts and Rs. 6,000.00 per r m of span for bridges. Bridges shall have to be designed on I.R.C. class A Loading and their detailed estimate shall have to be prepared separately.

A present land of 30 m width shall be required and has been provided in the estimate. Temporary land for borrowpits shall be required for one year for taking earth for embankment and provision has been made accordingly. The formation width of the road shall be 10 m and side slope 2 : 1 in banking and  $\frac{1}{2}$  : 1 in cutting.

The road shall be metalled with soling coat of brick on edge with overburnt bricks and two coats of metalling, inter coat and top coat, each of 8 cm compacted layer with stone ballast. The two wearing coats shall be of one coat of bituminous painting. Provisions for metalling and painting have been made in the estimate accordingly. Brick shall be burnt by contract by the side of road distributed along the road in three brick kilns. Coal shall have to be supplied to contractors for burning bricks and a statement of coal requirement is enclosed. Stone metal shall be hard granite type and shall be collected from the approved quarry.

The whole work of construction shall be spread in five years, earth work one year, rest for settlement one year, metalling two years and painting one year.

Second coat bituminous painting shall be done after one year of 1st coat of painting and cost of painting shall be met from maintenance grant.

All works shall be done strictly as per detailed P.W.D. Specifications. The estimate has been prepared at P.W.D. Schedule of rates and local current rates and analysis of rates have been given for non-schedule items. The work shall be done by contract by inviting tenders.

Survey Plan, L-sections and Cross-sections of the proposed road are enclosed with the estimate. An index plan showing the alignment has also been enclosed.

The estimate amounting to Rs. 25,00,000.00 has been submitted for sanction and allotment of fund.

### REPORTS ON THE ESTIMATE FOR THE CONSTRUCTION OF A DISTRIBUTARY-IRRIGATIONAL CHANNEL

It is proposed to provide irrigation facilities to the track of area adjoining the village Kashipur in Tehsil Maharaganj in the district Barabanki. For want of irrigation water the crops in the area fail and the people of the area represented and demanded repeatedly for the construction of an irrigation channel. This irrigation facility, if provided, will improve the crops in quantity and quality. During the present hardship of food problem it is all the more essential to bring more area under irrigation to grow more food. This estimate has, therefore, been prepared for irrigating the entire area.

This Kashipur Distributary takes off at 16 km—450 m of the right bank of the Nowan Distributary. Shajra maps (16"=1 mile) of the area have been taken for the selection of the alignment. Levelling has been done and contour lines and water shed lines have been marked on the Shajra map and the alignment has been fixed to follow the water shed line. The longitudinal level and cross levels have been taken along the alignment and 100 m apart and closer where required, and marked on the Shajra map L-section of the alignment to a horizontal scale of 10 cm=1 km and (1 cm=100 m) and vertical scale of 1 cm = 1 m has been prepared showing distance 1 km and 100 m, R.L. of ground, R.L. of bed, R.L. of F.S.L., bed width, depth of water, discharges, slopes per km, etc. Cross-section have also been prepared at every 100 m showing the G.L. and cross-section of proposed channel showing bed level F.S.L., bank level etc. The L-section has been approved by the Superintending Engineer on 20th April, 1970.

The nature of the soil is mostly loamy soil except in km 7 and 12 where the soil is mixed with kankar and bajri.

The channel is 16 km—400 m in length with a Tail Escape of 0—550 m and will serve, and irrigate new areas in the Tehsil Maharaganj. The area commanded are as follows :—

Gross commanded area	... 5900 hectare;
Cultivated command area	... 3170 hectare;
Uncultivated culturable area	... 1540 hectare;
Proposed rabi (30%+10%)	... (951 + 154) = 1105 hectare

The channel has been designed for 4 kor weeks, and discharge works out as 1 cu m per second. The channel will have a bed slope of 0.16 m per km (16 cm per km) and bed width of 3 m in the head reach.

Necessary drainage, crossings, falls, and foot bridges, etc., have been provided and included in the estimate. Head works and tail fall and necessary outlets have been provided. The Schedule of all these masonry structures have been prepared showing their positions kilometrewise and attached with the estimate. The position of the masonry work and outlets have also been marked in the Shajra map. The area under command has also been marked in the Shajra maps.

An index map of 2 cm=1 km showing the alignment, drainage crossings, falls, road crossings, etc., has been attached to indicate the whole lay-out at a glance.

A material statement of all important materials has been prepared and enclosed with the estimate.

All designs have been done on the basis of standard formulae and all calculations and designs are enclosed with the estimate. The estimate has been prepared at schedule of rates and analysis of rates have been prepared given for non-schedule items.

Financial Return has been worked out on the basis of the following :-

Revenue income per hectare irrigated—Rabi	...	@ Rs. 4.00 per hectare;
—Sugarcane	...	@ Rs. 10.00 per hectare;
—Rice	...	@ Rs. 10.00 per hectare;
—and others	...	@ Rs. 2.00 per hectare

Expenditure—Maintenance @ Rs. 150.00 per km, Establishment @ 3% of the capital cost and collection charges as revenue @ 3% of revenue realised.

The return works out as 6% of the total estimated cost and the project is productive.

The total cost of the estimate work out as Rs. 2,08,550.00. A general abstract of all the works involved in the plot has been prepared and attached with the estimate. The amount of the estimate is quite reasonable in consideration of the return and the additional area expected to be irrigated by the channel. The estimate is submitted for sanction and allotment of fund.

### PRACTICAL DATA AND INFORMATIONS

The following data and informations are only approximate and vary according to the location nature of works, structure, specifications, methods of construction, etc. For general idea and for preliminary estimate these will be helpful.

#### BUILDING WORKS

1. Cost of labour and materials—	30% to 35% of the whole cost.
(i) Cost on account of labour	70% to 65% of the whole cost.
(ii) Cost on account of materials	
2. Direct and overhead cost—	85% of the whole cost.
Direct cost on actual work (job)	
Overhead cost due to establishment, supervision, incidentals, etc.	15% of the whole cost.
3. (i) Cost of foundation and plinth	10% to 15% of the whole cost.
(ii) Cost of superstructure	90% to 85% of the whole cost.
4. Cost of second storey	85% to 90% of the first storey.
5. Cost of different parts or percentage break up of building (excluding sanitary and electrical works)—	
(a) Earthwork in excavation and filling	1/2% of the whole cost.
(ii) Concrete in foundation	5% of the whole cost.
(iii) Damp proof course	1% of the whole cost.
(iv) Brickwork	34% of the whole cost.
(v) Roofing	20% of the whole cost.
(vi) Flooring	6% of the whole cost.
(vii) Doors and windows	16% of the whole cost.
(viii) Plastering and pointing	10% of the whole cost.
(ix) White washing, colour washing, painting etc.	2% of the whole cost.
(x) Miscellaneous	5 1/2% of the whole cost.

Total 100% of the whole cost

6. Cost of Sanitary and electrical works —	
Sanitary and water supply installation	8% of the building cost.
Electric installation excluding fan	8% of the building cost.

7. Cost of materials and labour required for building, percentage distribution—	
(i) Cost of brick	22% of the whole cost.
(ii) Cost of cement	12% of the whole cost.
(iii) Cost of steel bars	10% of the whole cost.
(iv) Cost of timber	10% of the whole cost.
(v) Cost of other materials	14% of the whole cost.
(vi) Wages of labour	30% of the whole cost.
(vii) Workcharged establishment	2% of the whole cost.
Total	100% of the whole cost.

Note—If the estimated cost of the building and rates of materials are known the approximate quantities of materials can be calculated. Cost can be calculated approximately on plinth area basis.

8. Materials required on plinth area basis for single storey building —	
(i) Brick	500 nos. per sq m (500 nos. % sq ft) of plinth area
(ii) Cement	1.5 bags per sq m (1.5 bags per % sq ft) of plinth area
(iii) Mid steel bars	1.25 kg per sq m (2% cwt per % sq ft) of plinth area
(iv) Coal (slack of dust) for [burning bricks]	1.5 q per sq m (1 1/2 tons per % sq ft) of plinth area

9. Coal (slack or dust for burning bricks)	18 Tonne per lakh of bricks (output 60% I-class brick)
10. G.I. Sheet requirement for shed (24 gauge)	1 tonne per 1200 sq ft (0.85 q per sq m) of plinth area

11. Angle iron requirement for roof truss shed	4% cwt% sqft or 2% ton % sq ft. (0.5 q/sq m or 2.5 tonne % sq m) of plinth area.
--	--

12. Plinth area rates of different buildings (approximate) —	
(i) Residential building I-class	Rs. 5920.00 per sq m of plinth area.
	Rs. 550.00 per sq ft of plinth area.
(ii) Residential building II-class	Rs. 5380.00 per sq m of plinth area.
	Rs. 500.00 per sq ft of plinth area.
(iii) Residential building III-class	Rs. 4845.00 per sq m of plinth area.
	Rs. 450.00 per sq ft of plinth area.
(iv) Residential building IV-class	Rs. 4845.00 per sq m of plinth area.
	Rs. 450.00 per sq ft of plinth area.
(v) School and college building	Rs. 5920.00 per sq m of plinth area.
	Rs. 550.00 per sq ft of plinth area.
(vi) Hostel building	Rs. 5380.00 per sq m of plinth area.
	Rs. 500.00 per sq ft of plinth area.

(vii) Office building	Rs. 5920.00 per sq m of plinth area.
	Rs. 550.00 per sq ft of plinth area.
(viii) Hospital building	Rs. 5920.00 per sq m of plinth area.
	Rs. 550.00 per sq ft of plinth area.
(ix) Workshop building (sloping roof)	Rs. 3230.00 per sq m of plinth area.
	Rs. 300.00 per sq ft of plinth area.
(x) Model village house	Rs. 2150.00 per sq m of plinth area.
	Rs. 200.00 per sq ft of plinth area.
(xi) Multistoreyed framed building	Rs. 6460.00 per sq m of plinth area.
	Rs. 600.00 per sq ft of plinth area.
(xii) Air conditioning	Rs. 4300.00 per sq m of plinth area.
	Rs. 400.00 per sq ft of plinth area.

Note — For sanitary and water supply works add 8% of building cost.  
 For electric wiring add 7% of building cost.  
 For electric fans add 4% of building cost.

13. Annual repair and maintenance cost of building 1% to 1½% of the capital cost of the building, or 1 to 1½ months' rent

## BRIDGES AND CULVERTS

Cost of bridges and culverts on *r* m and *r* ft basis (approximate) —

(1) Culvert (small on village road)	Rs. 40,000.00 per <i>r</i> m of span.
	Rs. 12,000.00 per <i>r</i> ft of span.
(2) Culvert (big on main road)	Rs. 82,000.00 per <i>r</i> m of span.
	Rs. 25,000.00 per <i>r</i> ft of span.
(3) Bridges (small)	Rs. 1,15,000.00 per <i>r</i> m of span.
	Rs. 35,000.00 per <i>r</i> ft of span.
(4) Bridges (medium)	Rs. 1,65,000.00 per <i>r</i> m of span.
	Rs. 50,000.00 per <i>r</i> ft of span.
(5) Bridge (large)	Rs. 2,00,000.00 to 2,60,000.00 per <i>r</i> m of span.
	Rs. 60,000.00 to 80,000.00 per <i>r</i> ft of span.

(See also page 646 for cost of bridges and culverts for different widths of road way)

## ROAD WORKS

1. Cost of metalling of road per km 3.7 m width and per mile, 12' width (approx.)

(i) One layer of metalling 12 cm (4½") compacted to about 8 cm (3") with stone ballast	Rs. 2,50,000.00 per km.
	Rs. 4,00,000.00 per mile.
(ii) One layer of metalling 12 cm (4½") compacted to about 8 cm (3") with overburnt brick ballast	Rs. 2,00,000.00 per km.
	Rs. 3,20,000.00 per mile.
(iii) One layer of metalling with kankar metal 12 cm (4½") compacted to 8 cm (3")	Rs. 1,15,000.00 per km.
	Rs. 1,85,000.00 per mile.
	Rs. 2,70,000.00 per km.
(iv) One layer of overburnt brick flat soling	Rs. 1,68,000.00 per mile.

(v) 1st coat of bituminous painting	Rs. 70,000.00 per km.
	Rs. 1,13,000.00 per mile.
(vi) 2nd coat of bituminous painting	Rs. 40,000.00 per km.
	Rs. 64,000.00 per mile.
(vii) One layer of cement concreting 10 cm (4") thick layer	Rs. 7,00,000.00 per km.
	Rs. 11,25,000.00 per mile.

2. Cost for one km/mile of new road — 10 m (32') formation 3.7 m (12') metalled width overburnt brick flat soling, inter layer of overburnt brick ballast and top layer of stone metal and two coats of bituminous painting complete with B and C etc. Rs. 20.00 lakhs per km.  
 Rs. 32.00 lakhs per mile.

3. Annual maintenance and renewal cost of different type roads per km and per mile approximate—

(i) Earthen road 10 m (32') width	Maintenance - Rs. 3,730.00 per km (Rs. 6,000.00 per mile)
(ii) Kankar road 3.7 m (12') metalled width	Maintenance - Rs. 7,770.00 per km (Rs. 12,500.00 per mile)
	Renewal - Rs. 8,700.00 per km (Rs. 1,40,000.00 per mile)
(iii) Stone macadam road 3.7 m (12') metalled width	Maintenance - Rs. 7,500.00 per km (Rs. 12,000.00 per mile)
	Renewal - Rs. 1,86,000.00 per km (Rs. 3,00,000.00 per mile)
(iv) Bituminous road 3.7 m (12') metalled width	Maintenance - Rs. 4,700.00 per km (Rs. 7,500.00 per mile)
	Renewal - Rs. 37,000.00 per km (Rs. 60,000.00 per mile)
(v) Cement concrete road 3.7 m (12') metalled width	Maintenance - Rs. 3,400.00 per km (Rs. 5,500.00 per mile)

Maintenance work of road is divided into two parts, day-to-day repairs by gang of labourers, and renewals are required as —

- Kankar road — once in every 3 or 4 years, i.e. 1 or ¼ km every year.
- Stone macadam — once in every 4 or 6 years, i.e., ¼ or 1/5 km every year.
- Bituminous — once in every 5 or 6 years, i.e. 1/5 or 1 km every year.

4. Cost of construction of irrigation channels (approximate) —

(i) Channels of capacity up to 10 cusecs (0.3 cu m/sec.)	Rs. 1,30,000.00 per km.
	Rs. 2,10,000.00 per mile.
(ii) Channels of capacity above 10 up to 25 cusecs (0.3 to 0.7 cu m/sec.)	Rs. 1,75,000.00 per km.
	Rs. 2,82,000.00 per mile.
(iii) Channels of capacity above 25 up to 50 cusecs (0.7 to 1.4 cu m/sec.)	Rs. 2,55,000.00 per km.
	Rs. 4,10,000.00 per mile.
(iv) Channels of capacity above 50 up to 100 cusecs (1.4 to 2.8 cu m/sec.)	Rs. 3,20,000.00 per km.
	Rs. 5,15,000.00 per mile.
(v) Channels of capacity above 100 up to 150 cusecs (2.8 to 4.2 cu m/sec.)	Rs. 3,50,000.00 per km.
	Rs. 5,60,000.00 per mile.



- (vi) Channels of capacity above 150 up to 200 cusecs (4.2 to 5.6 cu m/sec.) — Rs. 4,50,000.00 per km. — Rs. 7,25,000.00 per mile.
- (vii) Channels of capacity above 200 up to 250 cusecs (5.6 to 7.0 cu m/sec.) — Rs. 5,00,000.00 per km. — Rs. 8,00,000.00 per mile.
- (viii) Channels of capacity above 250 up to 500 cusecs (7.0 to 14.0 cu m/sec.) — Rs. 5,00,000.00 to Rs. 6,60,000.00 per km. — Rs. 8,00,000.00 to Rs. 10,60,000.00 per mile.

2. Cost of irrigation project new development — Rs. 6,100.00 per hect. — Rs. 2,500.00 per acre. of land commanded.
3. Annual repair and maintenance cost of irrigation channels —
- (i) Minors Rs. 1500.00 per km (Rs. 2400.00 per mile)
- (ii) Distributaries Rs. 2300.00 per km (Rs. 3700.00 per mile)
- (iii) Branch canal Rs. 3000.00 per km (Rs. 4800.00 per mile)
- (iv) Main canal Rs. 4000.00 per km (Rs. 6400.00 per mile)

4. Cost of bridges and culvers across irrigation channels per r ft and r m of span (approximate) —

Type of Roadway	Foot Bridge	Cattle Bridge	Cattle Bridge	Village Road Bridge	Village Road Bridge	Main Road Bridge	Main Road Bridge
	4'	6'	8'	10'	16'	24'	32'
Width of Roadway	1.2 m	1.8 m	2.4 m	3.0 m	4.8 m	7.3 m	9.8 m

Span	Cost per running foot and per running metre of span						
4'	1000/- r ft.	2600/- r ft.	4500/- r ft.	5000/- r ft.	8000/- r ft.	—	—
1.2m	3200/- r m.	8500/- r m.	14700/- r m.	16400/- r m.	26200/- r m.	—	—
8'	900/- r ft.	2500/- r ft.	4500/- r ft.	4700/- r ft.	6500/- r ft.	17000/- r ft.	21500/- r ft.
2.4m	2950/- r m.	8200/- r m.	14700/- r m.	15400/- r m.	21300/- r m.	55700/- r m.	70500/- r m.
12'	700/- r ft.	2300/- r ft.	4000/- r ft.	4200/- r ft.	5500/- r ft.	15000/- r ft.	20000/- r ft.
3.7m	2300/- r m.	7500/- r m.	13000/- r m.	13800/- r m.	18000/- r m.	49000/- r m.	65500/- r m.
16'	550/- r ft.	2250/- r ft.	3700/- r ft.	4000/- r ft.	4700/- r ft.	14500/- r ft.	18500/- r ft.
4.8m	1800/- r m.	7400/- r m.	12100/- r m.	13100/- r m.	15400/- r m.	47600/- r m.	60700/- r m.
24'	420/- r ft.	1750/- r ft.	3200/- r ft.	3500/- r ft.	5000/- r ft.	13000/- r ft.	16000/- r ft.
7.3m	1400/- r m.	5700/- r m.	10500/- r m.	11500/- r m.	16400/- r m.	42600/- r m.	52500/- r m.

SANITARY AND WATER SUPPLY WORKS

1. Cost of complete sanitary fittings of one flush type latrine — Supplying and fixing including water connection, overhead tank of 50 gls. (22 litres) and sewer connection to a distance of 30.5 ft. (10 m) — Rs. 6800.00

2. Cost of sewerage system new construction — Rs. 500.00 per head of population.
3. Maintenance and running cost of sewerage system —
- (i) Sewer, line, etc. — 1% to 2% of capital cost.
- (ii) Machineries — 3% of the capital cost.

4. Cost of sewer line including laying and jointing approximate —

S.R. Pipe — Dia	S.R. Pipe —			Hume pipe —			
	4" (10 cm)	6" (15 cm)	9" (23 cm)	4" (10 cm)	6" (15 cm)	9" (23 cm)	12" (30 cm)
Cost per r ft	37.00	47.00	59.00	47.00	65.00	84.00	112.00
Cost per r m	120.00	155.00	195.00	155.00	215.00	275.00	370.00

5. Cost of septic tank and soak pit —

No. of Users	Cost of Septic Tank	Cost of Soak Pit
5	Rs. 3000.00	Rs. 1600.00
10	Rs. 5000.00	Rs. 2100.00
20	Rs. 7000.00	Rs. 2500.00
50	Rs. 11000.00	Rs. 4500.00
75	Rs. 17500.00	Rs. 5700.00
100	Rs. 22500.00	Rs. 6800.00

6. Cost of water supply, new construction

Rs. 600.00 per head of population.

7. Maintenance and running cost of water supply —

- (i) Pipe line, etc. — 1% of capital cost.
- (ii) Machineries — 3% of capital cost.

8. Cost of R.C.C. overhead storage tank 40' (12.5 m) high —

- (i) Up to 5000 gls. (22750 litre) — Rs. 56.00 per gl. (Rs. 12.00 per litre)
- (ii) Above 5000 gls. up to 10000 gls. (22750 litre to 45500 litre) — Rs. 48.00 per gl. (Rs. 10.00 per litre)
- (iii) Above 10000 gls. (above 45500 litre) — Rs. 40.00 per gl. (Rs. 9.00 per litre)

9. Cost of water pipe G.L. supplying and fixing complete —

Dia	2" (5 cm)	3" (7.5 cm)	4" (10 cm)	6" (15 cm)	9" (23 cm)	12" (30 cm)
Cost per r ft Rs.	54.00	68.00	80.00	113.00	177.00	224.00
Cost per r m Rs.	177.00	220.00	260.00	370.00	580.00	735.00

10. Lead and yarn required per joint in C.L. pipe —

Dia of Pipe	(3") (7.5 cm)	(4") (10 cm)	(6") (15 cm)	(8") (20 cm)	(10") (25 cm)	(12") (30 cm)	(14") (35 cm)	(16") (40 cm)	(18") (45 cm)	(20") (50 cm)	(24") (60 cm)
Lead	3 lb	4 1/2 lb	7 lb	10 lb	16 lb	19 lb	23 lb	27 lb	31 lb	38 lb	54 lb
Yarn	1.35	2	3.15	4.5	7.2	8.55	10.35	12.15	14.00	17.00	24.3
	kg	kg	kg	kg	kg	kg	kg	kg	kg	kg	kg
Yarn	2 oz	3 oz	5 oz	7 oz	8 oz	9 oz	11 oz	13 oz	17	17 1/2	27 1/2
	57 g	85 g	142 g	199 g	227 g	255 g	312 g	369 g	454 g	567 g	1.13 kg

Approximate cost of tubewell complete with sinking (Excluding pumping set) —

- (i) 1" (25 mm) dia, 100' (30 m) deep, G.L. pipe and strainer — 4800.00
- (ii) 1 1/2" (40 mm) dia, 200' (60 m) deep, G.L. pipe and strainer — 8600.00
- (iii) 2" (50 mm) dia, 200' (60 m) deep, G.L. pipe and strainer — 24500.00

(iv) 3" (75 mm) dia. 300' (90 m) deep, G.I. pipe and strainer	40000.00
(v) 4" (100 mm) dia. 300' (90 m) deep, W.I. black pipe and strainer	48000.00
(vi) 5" (125 mm) dia. 300' (90 m) deep, W.I. black pipe and strainer	78000.00
(vii) 6" (150 mm) dia. 300' (90 m) deep, W.I. black pipe and strainer	94000.00
(viii) 8" (200 mm) dia. 300' (90 m) deep, W.I. black pipe and strainer	157000.00
(ix) 10" (250 mm) dia. 300' (90 m) deep, W.I. black pipe and strainer	198000.00

#### Tube Well Irrigation —

(Data are only approximate)

Tube well — Tube well, total depth 450' (135 m) and consists of —

- Housing pipe, W.I. black pipe, 12" (300 mm) dia. 80' (24 m) long.
- Blind pipe, W.I. black pipe, 8" (200 mm) dia. 270' (81 m) long.
- Slotted strainer pipe, W.I. black pipe, 8" (200 mm) dia. 100' (30 m) long.

Boring done by Rotary zig to 27" (680 mm) diameter —

- Total cost of the tube well including boring, pipes, strainers, gravel surrounding strainer, pump house, development of well and other miscellaneous expenses — Rs. 2,74,000.00
- Channel (gal.) — Capacity 1.5 cusecs (0.045 cu m/sec.) Number of channels 3 or 4 radiating from the pump.  
Total length of brick lined channel — 1 mile cost @ Rs. 84,000.00 per mile (1.6 km @ Rs. 52,200.00 per km) including masonry work — Rs. 84,000.00  
Total length of unlined channel — 1 mile cost @ Rs. 28,700.00 per mile (1.6 km @ Rs. 17,800.00 per km) including masonry work — Rs. 28,700.00  
Total cost of channel — Rs. 1,12,700.00
- Pumping set. — Cost of pump set 12 to 15 H.P. including installation — Rs. 60,000.00

Grand Total

Rs. 4,46,700.00

Running and maintenance — The running and maintenance cost including salary of the pump driver, electrical charges for running pump maintenance of channels, depreciation, etc. — Rs. 35000.00 (per well)

Commanded area, Revenue, etc. —

Commanded area	700 acres (280 hectares)
Intensity of irrigation	60%
Discharge per well	32000 gal/hour, 1.5 cusecs (0.045 cu m/sec., 145300 litre/hour)
Irrigation charges	5700 ghs. per rupee (26000.00 litre per rupee)
Revenue income	Rs. 31,000.00 per well

Note — Housing pipe may be 10" (250 mm) dia. and blind and strainer pipe may be of 6" (150 mm) dia and bore may be of 15" (380 mm) dia. for housing pipe and 10" (250 mm) dia blind strainer pipe, and the cost may come to about Rs. 1,40,000.00.

Life of tubewell. — Life of a tubewell is about 10 years, after that period the yield is much reduced and it becomes uneconomical. The pipes may be taken out, the strainer may be reconditioned and the tubewell may be installed again nearby.

#### LINTELS — Dimensions and Reinforcements

(To carry 60° triangular load of wall)

Clear span	Minimum bearing	Overall depth of lintel	Thickness of wall	Reinforcements			
				Straight bars		Bent up bars	
				No.	Dia.	No.	Dia.
1.00 m [3'-3"]	15 cm [6"]	10 cm [4"]	10 cm [4½"]	2-6 mm	[¼"]	—	—
			20 cm [9"]	2-6 mm	[¼"]	1-6 mm	[¼"]
			30 cm [13½"]	2-8 mm	[5/16"]	1-8 mm	[5/16"]
1.25 m [4'-0"]	15 cm [6"]	10 cm [4"]	10 cm [4½"]	2-6 mm	[¼"]	—	—
			20 cm [9"]	2-8 mm	[5/16"]	1-8 mm	[5/16"]
			30 cm [13½"]	2-8 mm	[5/16"]	2-8 mm	[5/16"]
1.50 m [5'-0"]	15 cm [6"]	15 cm [6"]	10 cm [4½"]	2-6 mm	[¼"]	—	—
			20 cm [9"]	2-8 mm	[5/16"]	1-8 mm	[5/16"]
			30 cm [13½"]	2-8 mm	[5/16"]	2-8 mm	[5/16"]
1.75 m [6'-0"]	15 cm [6"]	15 cm [6"]	10 cm [4½"]	2-8 mm	[5/16"]	—	—
			20 cm [9"]	2-8 mm	[5/16"]	2-8 mm	[5/16"]
			30 cm [13½"]	2-10 mm	[¾"]	2-10 mm	[¾"]
2.00 m [6'-6"]	20 cm [8"]	20 cm [8"]	10 cm [4½"]	2-8 mm	[5/16"]	—	—
			20 cm [9"]	2-8 mm	[5/16"]	2-8 mm	[5/16"]
			30 cm [13½"]	2-10 mm	[¾"]	2-10 mm	[¾"]
2.25 m [7'-6"]	20 cm [8"]	20 cm [8"]	10 cm [4½"]	2-10 mm	[¾"]	—	—
			20 cm [9"]	2-10 mm	[¾"]	2-10 mm	[¾"]
			30 cm [13½"]	2-12 mm	[½"]	2-12 mm	[½"]
2.50 m [8'-0"]	25 cm [10"]	25 cm [10"]	10 cm [4½"]	2-10 mm	[¾"]	—	—
			20 cm [9"]	2-10 mm	[¾"]	2-10 mm	[¾"]
			30 cm [13½"]	2-12 mm	[½"]	2-12 mm	[½"]
2.75 m [9'-0"]	25 cm [10"]	25 cm [10"]	10 cm [4½"]	2-12 mm	[½"]	—	—
			20 cm [9"]	2-12 mm	[½"]	2-12 mm	[½"]
			30 cm [13½"]	2-14 mm	[9/16"]	2-14 mm	[9/16"]
3.00 m [10'-0"]	30 cm [12"]	30 cm [12"]	10 cm [4½"]	2-12 mm	[½"]	—	—
			20 cm [9"]	2-12 mm	[½"]	2-12 mm	[½"]
			30 cm [13½"]	2-14 mm	[9/16"]	2-14 mm	[9/16"]

Notes of Lintels (above table) —

If the bars of the required diameter are not available the next higher diameter bars should be used.

The bent up bars should be bent up 45° at 1/5 span from the support. Though shear stresses are low and within the permissible stresses, nominal stirrups of 6 mm (¼") dia. bars will be provided at 25 cm (6") apart. To assist the assembly of the reinforcements additional bars, 2 nos. — 6 mm (¼") dia. for spans up to 1.5 m (5'), and 2 nos. — 10 mm (¾") dia. for larger spans may be provided on the top and the number bending up may be reduced accordingly.

For smaller spans the thickness may be reduced to 7.5 cm (3") and reinforcements may be kept same as for 1 m (3'-3") span.

**R.C.C. Slab — Thickness of Slab and Reinforcements for Different Spans for Simply Supported**

Effective span=clear span plus one bearing. Minimum bearing = 15 cm (6")  
 c=50 kg per sq m, t = 1400 kg per sq cm, N = .40, J = .87, Q = c N j = 8.7, b = 100 cm

/Span effective bearing c. to c. metre (ft)	Dead load					Main Reinforcement					Distr. bars		
	Live load 147 kg per m <sup>2</sup> (30 lbs/ft <sup>2</sup> )	L.C. terracing 147 kg per m <sup>2</sup> (30 lbs/ft <sup>2</sup> )	Wt. of R.C.C. Slab kg/m <sup>2</sup> (lbs/ft <sup>2</sup> )	Total load kg/m <sup>2</sup> (lbs/ft <sup>2</sup> )	w Total load kg/m <sup>2</sup> (lbs/ft <sup>2</sup> )	M B.M. = $\frac{w l^2}{8}$ kg cm (lb in)	Depth effective $d = \sqrt{\frac{M}{Q}}$ cm (inches)	Total depth of slab cm (inches)	Area of Steel $A_s = \frac{M}{j d}$ cm <sup>2</sup> (inch <sup>2</sup> )	Dia. and size of one bar	Spacing of bar = $\frac{A_s}{b}$ cm (inch)	Area 20% of main bars cm <sup>2</sup> (inch <sup>2</sup> )	Dia. and spacing 6 mm $\phi$ ( $\frac{1}{4}$ " $\phi$ )
3.70 m	147 kg/m <sup>2</sup>	147 kg/m <sup>2</sup>	288 kg/m <sup>2</sup>	582 kg/m <sup>2</sup>	582 kg	99595 kg cm	10.7 cm	12 cm	7.73 cm <sup>2</sup>	10 mm $\phi$ 0.79 cm <sup>2</sup>	10 cm	1.55 cm <sup>2</sup>	6 mm $\phi$ 18 cm
12'	30 lbs/ft <sup>2</sup>	30 lbs/ft <sup>2</sup>	54 lbs/ft <sup>2</sup>	114 lbs/ft <sup>2</sup>	114 lbs	24624 lb in	3.86"	4.5"	0.4 in <sup>2</sup>	$\frac{3}{8}$ " $\phi$ .11 in <sup>2</sup>	3"	0.08 in <sup>2</sup>	$\frac{1}{4}$ " $\phi$ 7.25"
3.30 m	"	"	264 kg	558 kg	558 kg	80493 kg cm	9.68 cm	11 cm	6.23 cm <sup>2</sup>	10 mm $\phi$ 0.79 cm	12.5 cm	1.245 cm <sup>2</sup>	22 cm
11'	"	"	48 lb	108 lb	108 lb	19602 lb in	3.44"	4"	0.362 in <sup>2</sup>	$\frac{3}{8}$ " $\phi$ .11 in <sup>2</sup>	3.7"	0.073 in <sup>2</sup>	8"
3.00 m	"	"	240 kg	534 kg	534 kg	60075 kg cm	8.31 cm	10 cm	5.74 cm <sup>2</sup>	10 mm $\phi$ 0.79 cm <sup>2</sup>	13.5 cm	1.147 cm <sup>2</sup>	24 cm
10'	"	"	45 lb	105 lb	105 lb	15750 lb in	3.1 in	3.75"	0.3 in <sup>2</sup>	$\frac{3}{8}$ " $\phi$ .11 in <sup>2</sup>	4.25"	0.06 in <sup>2</sup>	9.5"
2.70 m	"	"	216 kg	510 kg	510 kg	46474 kg cm	7.3 cm	9 cm	5.30 cm <sup>2</sup>	10 mm $\phi$ 0.79 cm <sup>2</sup>	15.5 cm	1.03 cm <sup>2</sup>	27 cm
9'	"	"	39 lb	99 lb	99 lb	12029 lb in	2.7"	3.25"	0.283 in <sup>2</sup>	$\frac{3}{8}$ " $\phi$ .11 in <sup>2</sup>	4.7"	0.057 in <sup>2</sup>	10.5"

2.40 m	"	"	192 kg	486 kg	486 kg	34992 kg cm	6.54 cm	8 cm	4.34 cm <sup>2</sup>	10 mm $\phi$ 0.79 cm <sup>2</sup> or 8 mm $\phi$ 0.5 cm <sup>2</sup>	18 cm	0.87 cm <sup>2</sup>	33 cm
8'	"	"	36 lb	96 lb	96 lb	9216 lb in	2.36"	3"	0.238 in <sup>2</sup>	$\frac{3}{8}$ " $\phi$ .11 in <sup>2</sup>	5.5"	0.048 in <sup>2</sup>	12.5"
2.10 m	"	"	168 kg	462 kg	462 kg	25468 kg cm	5.41 cm	7 cm	3.71 cm <sup>2</sup>	8 mm $\phi$ 0.50 cm <sup>2</sup>	13.5 cm	0.742 cm <sup>2</sup>	37 cm
7'	"	"	36 lb	96 lb	96 lb	7056 lb in	2.06"	3"	0.182 in <sup>2</sup>	$\frac{3}{8}$ " $\phi$ .11 in <sup>2</sup>	7.0"	0.036 in <sup>2</sup>	16"
1.80 m	"	"	168 kg	462 kg	462 kg	18711 kg cm	4.64 cm	7 cm	2.72 cm <sup>2</sup>	8 mm $\phi$ 0.50 cm <sup>2</sup>	18.0 cm	0.544 cm <sup>2</sup>	50 cm
6'	"	"	36 lb	96 lb	96 lb	5184 lb in	1.77"	3"	0.134 in <sup>2</sup>	$\frac{3}{8}$ " $\phi$ .11 in <sup>2</sup>	10"	0.027 in <sup>2</sup>	24"
1.50 m	"	"	168 kg	462 kg	462 kg	12994 kg cm	3.87 cm	7 cm	1.92 cm <sup>2</sup>	8 mm $\phi$ 0.50 cm <sup>2</sup>	26.0 cm	0.38 cm <sup>2</sup>	73 cm
5'	"	"	36 lb	96 lb	96 lb	3600 lb in	1.6"	3"	0.093 in <sup>2</sup>	$\frac{3}{8}$ " $\phi$ .11 in <sup>2</sup>	14"	0.0186 in <sup>2</sup>	31"
1.20 m	"	"	168 kg	462 kg	462 kg	8316 kg cm	3.09 cm	7 cm	1.21 cm <sup>2</sup>	8 mm $\phi$ 0.50 cm <sup>2</sup>	41.0 cm	0.242 cm <sup>2</sup>	115 cm
6'	"	"	36 lb	96 lb	96 lb	2304 lb in	1.3"	3"	0.06 in <sup>2</sup>	$\frac{3}{8}$ " $\phi$ .11 in <sup>2</sup>	14"	0.12 in <sup>2</sup>	49"

**Note**—Alternate main bars shall be bent up at a distance of 1/5 span from supports. Total load w, total of cols. 2, 3 and 4, per sq m of floor area, is same as load per running metre of slab.  
**Roof Load**—Live Load—147 kg per sq m (30 lbs/sq ft) and Dead load—Weight of 7.5 cm (3") L.C. terracing plus weight of R.C.C. slab  
**Floor Load**—For storeyed building. Live load—195 kg per sq m (40 lbs/sq ft) and Dead load—Weight of R.C.C. slab and 2.5 to 4 cm (1" to 1 1/2") c.c. floor.  
 Both loading (roof load and floor load) may be equal approximately and same design for roof will hold good for floor.  
**Thickness of R.C.C. slab**—Total over-all depth (thickness) of slab is equal to effective depth plus bottom cover of 1 cm to 2 cm (1/2" to 3/4"). Minimum thickness may be taken as 7 cm (3").  
**Diameter of bars**—Diameter of main bars should not be less than 8 mm (3/4").  
**Spacing of bars centre to centre**—Spacing of main bars should not be greater than twice the effective depth (2d) of slab. Spacing of distributing bars should not be greater than four times the effective depth (4d) of slab. Spacing of bars for spans 2.10 m (7'), 1.8 m (6'), 1.50 m (5') and 1.20 m (4') may be adjusted accordingly.

**R.C.C. slab**—Thickness of slab and reinforcements for different spans for simply supported.  
(Abstract of previous table in short)

Span effective l	B.M. $wl^2$ kg cm	Depth of slab		Main reinforcement		Distributing bars	
		Effective cm	Total cm	Area cm <sup>2</sup>	Dia and Spacing	Area cm <sup>2</sup>	Dia. and Spacing
3.70 m (12')	99,595	10.79	12	7.73	10 mm dia. @ 10.0 cm	1.55	6 mm dia. @ 18 cm
3.30 m (11')	80,495	9.68	11	6.23	10 mm dia. @ 12.7 cm	1.245	6 mm dia. @ 22 cm
3.00 m (10')	60,075	8.31	10	5.74	10 mm dia. @ 13.5 cm	1.147	6 mm dia. @ 24 cm
2.70 m (9')	46,474	7.30	9	5.30	10 mm dia. @ 15.5 cm	1.03	6 mm dia. @ 27 cm
2.40 m (8')	34,992	6.34	8	4.34	10 mm dia. @ 18.0 cm or 8 mm dia. @ 11.5 cm	0.87	6 mm dia. @ 32 cm
2.10 m (7')	25,468	5.41 Min. 5.50	7	3.71	8 mm dia. @ 13.5 cm	0.742	6 mm dia. @ 37 cm
1.80 m (6')	18,711	4.64 Min. 5.50	7	2.72	8 mm dia. @ 18.0 cm	0.544	6 mm dia. @ 50 cm
1.50 m (5')	12,994	3.87 Min. 5.50	7	1.90	8 mm dia. @ 26.0 cm	0.38	6 mm dia. @ 73 cm
1.20 m (4')	8,316	3.09 Min. 5.50	7	1.21	8 mm dia. @ 41.0 cm	0.242	6 mm dia. @ 115 cm

#### STRUCTURAL DESIGN OF BUILDING AND THUMB RULES

**Depth of foundation**—Depth of foundation is calculated by Rankine's Formula.

$$D = \frac{p}{w} \left( \frac{1 - \sin \phi}{1 + \sin \phi} \right)^2$$

where  $p$  = safe permissible pressure on base (soil) in kg/sq m (lb/sq ft),  
 $w$  = weight of soil in kg/cu m (lb/cu ft),  $\phi$  = angle of repose of soil and  $D$  = depth of foundation in metre (ft). For average good soil  $\phi = 30^\circ$ ,  $p = 10$  tonne/sq-m and  $w = 1600$  kg/cu m.

To prevent the weather effect, the minimum depth of foundation is taken as 90 cm (3 ft) for outer walls and 60 cm (2 ft) for inner walls. In filled up soil the foundations should be taken to the firm soil, or foundation should be supported over piles.

#### Masonry Pillars and Walls—

**Pillars**—For foundation of pillars find the total load  $W$  on the foundation inclusive of the weight of pillar and foundation masonry, the area of foundation  $A = W/p$ , where  $p$  is the safe bearing capacity of soil. The sides of foundation =  $\sqrt{A}$ .

For size of the pillar in superstructure find the total load  $W_1$  on the pillar inclusive of weight of masonry of pillar (excluding foundation), then sectional area of pillar  $A = W_1/f$ , where  $f$  is the safe permissible load on the masonry of pillar. The sides of pillar =  $\sqrt{A_1}$ .

**Illustration**—Total load on the foundation of pillar is 20 tons. Foundation area =  $\frac{20}{p} = \frac{20}{10} = 2$  sq m,  $p$  = safe bearing capacity of soil = 10 tonne per sq m. Therefore, the size of foundation  $\sqrt{A_2} = 1.42$  m i.e., foundation will be 1.42 m  $\times$  1.42 m.

If the total load on the pillar is 18 tonne inclusive weight of pillar, sectional area of pillar =  $\frac{18}{f} = \frac{18}{60} = 0.3$  sq m,  $f$  = permissible stress on masonry = 60 tonne per sq m for masonry of 1 : 6 cement mortar. Size of pillar =  $\sqrt{0.3} = 0.55$  m, i.e., pillar will be 55 cm  $\times$  55 cm; for practical purpose the pillar will be 60 cm  $\times$  60 cm or 60 cm  $\times$  50 cm.

**Walls**—For width of foundation calculate the total load  $W$  in tonne per metre length (in ton per ft. length) of the wall which will include the roof load, floor load, wall load and foundation load. Width of foundation,  $B = W/p$ , where  $p$  = safe bearing capacity of soil in tonne/sq m (ton/sq ft) and  $B$  = width of foundation in metre (ft). It may be noted that actually  $B$  is the area of foundation for unit length and the area divided by unit gives the width.

For thickness of wall  $B = W_1/f$ , where  $W_1$  is the load per metre length of wall inclusive of weight of masonry, and  $f$  = safe permissible load on masonry.

**Illustration**—Total load on per metre length of the foundation of wall inclusive weight of wall and foundation  $W = 15$  tons. Width of foundation  $B = \frac{W}{p} = \frac{15}{10} = 1.5$  m.

If the total load on the wall is 14 tonne per metre inclusive weight of wall then the thickness of wall  $B = \frac{14}{60} = 0.233$  m = 24 cm, for practical purposes the thickness of wall will be 30 cm.

**Thumb rule of width foundation**— $B = 2T + 2 \times O$ , where  $T$  = thickness of wall at the plinth level, and  $O$  = concrete offset of footing on each side which is usually 15 cm (6").

**Thickness of foundation concrete**—The relation between thickness of foundation concrete and the offset (footing) is given by  $\frac{O}{t} = \sqrt{\frac{f}{3p}}$  or  $t^2 = \frac{3pO^2}{f}$ , where  $p$  = safe bearing capacity of soil in tonne/sq m or ton/sq ft (10 tonne/sq m or 1 ton/sq ft for average good soil),  $O$  = concrete offset in metre (ft),  $f$  = safe permissible stress of concrete in tonne/sq m (ton/sq ft), and  $t$  = thickness of concrete in metre (ft). For lime concrete  $f = 30$  tonne/sq m (3 ton/sq ft) and for cement concrete of 1 : 4 : 8 proportion  $f = 100$  tonne/sq m (10 ton/sq ft).

Foundation concrete may be of lime concrete or lean (weak) cement concrete of proportion 1 : 4 : 8 or 1 : 5 : 10. Instead of calculating thickness of foundation, the thickness is usually taken as—

15 cm (6") for building 3 m (10 ft) height, 20 cm (8") for 3 m to 4.5 m (10' to 15') height, 25 cm (10") for 4.5 m to 6 m (15' to 20') height, and 30 cm (12") for building above 6 m (20') height.

**Pier**—The wall in between window or door opening or verandah piers should be designed and checked for the safe permissible stress of masonry, on the same principle as for pillars. If  $a$  is the length of the pier and  $b$  is the thickness and  $W$  is the load on the pier inclusive its own weight, then the stress  $f = \text{Load/sec. area} = W/ab$  which should be within safe stress.

**Illustration**—If the load on a pier inclusive its own weight is 10 tonne and the size of the pier is 50 cm  $\times$  30 cm then stress  $f = 10/(.5 \times .3) = 10/.15 = 66.67$  tonne/sq m, if the brick work of wall is of lime

mortar then it is not safe, the pier should be constructed with cement mortar of 1 : 5 or 1 : 4, alternatively the size of the pier should be increased.

Note—Foundation of the heavy structures, storeyed buildings, etc. are now-a-days designed by finding the shear stress of foundation soil by Soil Mechanics Technique.

**R.C.C. DESIGN, DATA, STRESSES, FORMULAE, Etc., IN METRIC AND F.P. SYSTEMS**

Permissible stresses for cement concrete (Based on I.S.I.)—

Concrete Mix	Compressive Stresses Direct	Compressive Stresses Bending	Shear Stresses	Bond Stresses
Mix No. Prop.	kg/sq cm	kg/sq cm	kg/sq cm	kg/sq cm
M 100 1 : 3 : 6	25	30	3.0	4.0
M 150 1 : 2 : 4	40	50	5.0	6.0
M 200 1 : 1½ : 3	50	70	7.0	8.0
M 250 1 : 1 : 2	60	85	8.0	9.0

**Permissible stresses in steel (M.S.) reinforcements —**

- Tension other than helical reinforcement in column :—
  - (a) Up to 40 mm dia. bars 1400 kg/sq cm.
  - (b) Over 40 mm dia. bars 1300 kg/sq cm.
- Tension in helical reinforcement in columns 1000 kg/sq cm.
- Tension in shear reinforcement in beams 1400 kg/sq cm.
- Compression in longitudinal reinforcement in columns 1300 kg/sq cm.
- Compression in bars in beam or slab where compressive resistance of concrete is not taken into account :—
  - (a) Up to 40 mm dia. bars 1400 kg/sq cm.
  - (a) Over 40 mm dia. bars 1300 kg/sq cm.

**Notations and Formulae for design of R.C.C. beam—**

- $f_t$  = permissible tensile stress in steel (1.100 kg/sq cm)
- $c$  = permissible compressive stress in concrete (50 kg/sq cm)
- $E_s$  = Modulus of Elasticity of steel ( $21 \times 10^6$  kg/sq cm)
- $E_c$  = Modulus of Elasticity of concrete ( $1.4 \times 10^6$  kg/sq cm)
- $m$  = Modular ratio =  $E_s/E_c$
- $b$  = Breadth of beam or slab in cm
- $d$  = Effective depth of beam in cm
- $D$  = Total depth of beam in cm
- $N$  = Constant of neutral axis =  $\frac{c}{c+t/m}$
- $j$  = Lever arm constant =  $1 - \frac{N}{3}$
- $a$  = Lever arm =  $j d$
- $n$  = Distance of neutral axis from compression (upper) edge =  $Nd$
- $C$  = Total compression in beam section  $\frac{1}{2} c b n$  (Total compressive resisting force)
- $T$  = Total tension in beam section =  $A_s f_t$  (Total tension resisting force)
- $A_s$  = Area of steel reinforcement =  $M/t a = M/j d$
- $r$  = Ratio of steel area to concrete area  $A_s/b d$
- $P$  = Percentage reinforcement in a section =  $\frac{A_s}{b d} \times 100 = \frac{50 c N}{i}$
- $Q$  = Resisting moment constant =  $\frac{1}{2} c N j$
- $B. M. = M$  = Resisting moment due to compression =  $Q b \times d^2 = C \times a$
- $B. M. = M$  = Resisting moment due to tension =  $A_s t a = T \times a$
- $C = T$  or  $\frac{1}{2} c b n = A_s f_t$
- Resisting moment are equal —  $Q b d^2 = A_s t a$

Note—For design in metric system linear unit is in centimetre, the square unit is in sq cm, and the weight and force unit is in kg.

As per I.S.I. recommendation Modular ratio  $m = 2800/3 f_c$ , where  $3 f_c = c$  = permissible compressive stress in kg/sq cm in concrete due to bending.

**Value of constants for different stresses**

	c	t	m	N	j	P	Q	Resisting moment	
F.P. Units	600 lbs/sq in	1600 lbs/sq in	15	0.39	0.880	0.675	95	$M=95 b d^2$	b and d in inches
—	750	18000	15	0.385	0.870	0.664	126	$M=126 b d^2$	
—	750	18000	18	0.428	0.857	0.690	138	$M=138 b d^2$	
—	1000	20000	15	0.455	0.848	1.265	193	$M=193 b d^2$	
Metric Units	50 kg/sq cm	1400 kg/sq cm	18.7	0.400	0.870	0.712	8.7	$M=8.7 b d^2$	b and d in cm
$m = 2800$	60	1400	15.55	0.375	0.875	0.803	9.8	$M=9.8 b d^2$	
$3L$	70	1400	13.33	0.400	0.867	1.000	12.1	$M=12.1 b d^2$	
	80	1400	11.70	0.400	0.867	1.140	13.9	$M=13.9 b d^2$	

**Design of R.C.C. Beam—** The same notations may be used for both Metric System and F.P. System with their respective units.

Depth of the beam is assumed as 1/10 to 1/12 effective span and breadth as .5 to .7 of depth. Main reinforcements are designed to resist the maximum bending moment, and stirrups are designed to resist shear force. Floor load both live and dead of one spacing of beam (centre to centre of spacing) will come on the beam, and this load together with self load of the beam shall be taken for design.

For heavy load, for large span, or when the depth of the beam is required to be reduced the beam should be designed as doubly reinforced.

In Metric System stresses should be taken in kg/sq cm 'b' and 'd' in cm. For design of beam find w load in kg per metre and calculate maximum bending moment from  $B.M. = \frac{w l^2}{8} = \frac{w \times l \times j \times 100}{8}$  kg cm, where  $l$  = effective span in metre. Knowing  $c$ ,  $t$  and  $m$ ,

$N$  can be found from  $N = \frac{c}{c+t/m}$ . Then find  $j$  from  $j = 1 - \frac{N}{3}$  and find  $Q$  from  $Q = \frac{1}{2} c N j$

Then find the depth  $d$  from  $B.M. = Q b d^2$ , assuming  $b = .66 d$ . Find lever arm 'a' from  $a = j d$ . Calculate area of steel from  $B.M. = A_s t a$ , choose suitable diameter and number of bars.

**Check for shear—** Find shear stress at any section  $s = \frac{S}{b a}$ , where  $S$  = Total shear force across the section usually at the support. Shear stress  $s$  should be within permissible shear stress (5.3/sq cm), if not safe provide shear reinforcement by stirrups.

Spacing of stirrups (two legged) =  $\frac{2 A_s t a}{S}$ , where  $A_s$  is the sectional area of one bar chosen for stirrup.

Check for bond—Find bond stress at any section  $sb = \frac{S}{Oa}$ , where  $O$  is the total perimeter of

all tensile bars. Bond stress  $sb$  should be within permissible stress (7.0 kg/sq cm).

**Design of R.C.C. Slab**—Thickness of R.C.C. slab may be assumed as 1/24 of effective span. Main reinforcements are designed for short span for maximum bending moment and 20% of main bars are provided for distributing bars along the long span.

For square slab or when the length is 1½ times the breadth, the slab is designed as two-way reinforced slab.

For design of slab take one-metre width i.e.  $b=100$  cm. and design as rectangular beam. Find load per sq m of slab including live load and dead load and calculate maximum bending moment from  $B.M. = \frac{wl^2}{8}$ , then find  $d$  from  $B.M. = Qbd^2$ ,  $b$  being 100 cm. Calculate area of steel from  $B.M. = A_s tjd$ . Choose suitable diameter and find spacing of main bars from,  $\text{spacing} = \frac{a_s \times 100}{A_s}$  cm,

where  $A_s$  = total area of bar required for 100 cm width,  $a_s$  = area of one bar chosen. Provide distributing bars 20% of main bars i.e. 20% of  $A_s$  per 100 cm. Choose diameter of one distributing bar and spacing on the same principle of main bars. For continuous slab take  $B.M. = wl^2/10$  or  $wl^2/12$ . (See Table in pages 650-653 for R.C.C. slab design for different spans).

**Two way reinforced slabs or slab supported on four sides**—When the slab is square or rectangle having the ratio of length ( $L$ ) and breadth ( $B$ ) 1½ or even 2, the total load is distributed on four sides and the slab is designed to span both ways.

**Two way R.C.C. slabs with edges simply supported, corners not held down**—Such slabs are designed when there is no wall above the slab, usually for the roof slab of a building.

**Design**—Find the total load  $w$  on the slab both dead and live load per sq m (sq ft). The distribution of load on short span  $B$  and long span  $L$  are given by:—Load on short span,  $w_s = K_s w$  where  $K_s$  = co-efficient =  $L^2 / (B^2 + L^2)$ . Load on long span,  $w_l = K_l w$  where  $K_l$  = co-efficient =  $B^2 / (B^2 + L^2)$ .

First design for short span for load  $w_s$  per sq m on the same principle as for slab described above. Find B.M. then find effective depth  $d$  from  $B.M. = Qbd^2$  then find area  $A_s$  of main steel from  $B.M. = A_s tjd$ , choose diameter and find spacing.

Next design for long span for load  $w_l$  per sq m. Take effective depth as  $d$  minus one diameter of bar for short span. (Depth need not be designed). Find B.M. for long span and find area of steel on the same principle (as above), choose diameter and find spacing.

Design of distributing bars are not required as bars of one direction will work as distributing bars for the other direction.

For different ratios of length and breadth, ( $r=L/B$ ) the load co-efficients  $K_s$  and  $K_l$  are as given below:—

$r$	1	1.1	1.2	1.3	1.4	1.5	1.6	1.7	1.9	2
$K_s-0.5$	0.59	0.68	0.74	0.79	0.83	0.87	0.90	0.93	0.94	0.96
$K_l-0.5$	0.41	0.32	0.26	0.21	0.17	0.13	0.10	0.07	0.06	0.04

**Two way reinforced slab (supported on four sides) with corners held down**—This type square or rectangular slab is designed when there are walls above the slab and uniformly loaded. In such cases the load co-efficients are calculated by empirical formula and are as given below:—

Load co-efficient for different ratio of length and breadth—

$r$	1.10	1.20	1.30	1.40	1.50	1.60	1.75
$K_s-0.30$	0.36	0.42	0.48	0.53	0.58	0.63	0.68
$K_l-0.30$	0.24	0.19	0.15	0.13	0.11	0.09	0.07

Design may be done on the same principle as above, first the design is made for short span and then for long span. The reinforcements as per design for maximum B.M. are placed to both directions only in the middle 4/5 strips, that rectangle formed by 4/5  $L \times 4/5 B$ . At the corners 1/5 span in both direction reinforcements are given both at bottom and top in the form of mesh. The area of reinforcements at the meshes at the top and bottom each should be same as the bottom designed reinforcement in the short span at the centre of the slab. In the remaining edge strips reinforcement may be given as alternate bars of the middle strip and in addition top bars of 10 mm dia. should be given in the form of pieces for 1/5 span in the space in between bottom bars but at the top. For simplicity instead of reducing bars at the edge strips alternate bars may be bent up at 1/5 span and extra top bars may be avoided.

#### Reinforced Brickwork—

The following stresses may be taken for designing of R.B. work:—

(1) Permissible stress in steel,  $t=1400$  kg/cm<sup>2</sup> (20000 lb/sq in), (2) Permissible compressive stress in bending in brickwork,  $c=30$  kg/cm<sup>2</sup> (425 lb/in<sup>2</sup>) varying from 20 to 35 kg/cm<sup>2</sup> depending on the quality of bricks and mortar, (3) Modular ratio,  $m=40$ , (4) Permissible shear stress= $1.4$  kg/cm<sup>2</sup> (20 lb/in<sup>2</sup>), (5) Permissible bond stress= $6$  kg/cm<sup>2</sup> (60 lb/in<sup>2</sup>), (6) Resisting moment constant,  $Q=4.5$ .

Design may be done on the same principle as for R.C.C. work.

**Design of R.B. Slab**—Find the load  $w$  per sq m of slab including dead load and live load, calculate bending moment from  $B.M. = wl^2/8$ . Then find  $a$  from  $B.M. = Qbd^2$ ,  $d$  being 100 cm. The depth of R.B. slab cannot be anything as in the case of R.C.C. the depth may be one flat brick, one brick-on-edge two flat bricks etc. Find the area of the steel from  $B.M. = A_s tjd$ ,  $d$  being the effective depth of the slab chosen. The bars are placed in between bricks with 4 cm mortar joint and the spacings are fixed and hence the diameter of the bar should be chosen to provide the required area of steel. The diameter of bar may be found from,  $\text{spacing} = \frac{a_s \times 100}{A_s}$ . Distributing bars should be 20% of the main bars and may be designed similarly.

**R.C.C. Lintel**—Thickness of R.C.C. lintel may be taken as 1/12 of effective span. Lintel are designed to carry 60° triangular load of wall with sides as effective span  $T$  and self load of lintels for maximum bending moment  $\frac{Wl}{6} - \frac{wl^2}{8}$ .  $W$  is the total weight of the 60° triangular wall, and  $w$  is the

weight of lintel per unit length.

For details of R.C.C. lintel for different spans see page 649.

Thickness of stone lintel may be taken as 1/12 span + 2.5 cm (1").

**Doubly Reinforced Beam**—When the load on the beam is heavy, or span of the beam is large or the depth of beam is restricted, the beam is designed as doubly reinforced. In such case the concrete alone cannot resist the compression developed in the upper part and hence steel is provided in the upper part also to resist compression.

**Design**—Depth  $d$  and breadth  $b$  are known or assumed suitably: (1) Find for the balanced section,  $n=Nd$ , where  $d$  is effective depth (total depth minus bottom cover say 4 cm) and  $N=40$ . (2) Find moment of Resistance,  $M.R. = Qbd^2$ , where  $Q=8.7$ . (3) Find tension steel for the M.R. from  $A_s = \frac{M.R.}{tjd}$  where  $j=.87$ . Find B.M. for loading (both live load

and dead load), B.M. =  $wl^2/8$ . (4) Find balance Bending Moment, B. Mb = B.M. — M. R<sub>v</sub>.  
 (5) Find additional steel for the balance Bending Moment from  $A_c \times r \times \text{lever arm} = \text{B.M.} - \text{M.R.}$ .  
 M.R. Lever arms should be taken as the distance from the centre of bottom bar to the  
 centre of top bar =  $d - d_c$ ,  $d_c$  being the top cover.  $A_c = \frac{\text{B.M.} - \text{M.R.}}{r(d - d_c)}$  (6) Total tension steel

$A_s = A_c + A_t$ . Choose dia. and find number of bars for bottom.

Compression steel—(7) Find the compressive stress in steel,  $t_c = (m - 1) c_c$ , where  $c_c = \frac{c(n - d_c)}{n}$ ,  
 $c_c$  being the compressive stress in concrete adjacent to compression steel.  $c_c = \frac{(m - 1) c(n - d_c)}{n}$

(8) Find compression steel for the balance bending moment B. Mb. from  $A_c \times t_c \times \text{lever arm} = \text{B.M.} - \text{M.R.}$ .  
 $A_c = \frac{\text{B.M.} - \text{M.R.}}{t_c(d - d_c)}$  lever arm being  $d - d_c$ .

The excess or balance Bending Moment should not be greater than  $\frac{1}{4}$  of the M.R. of the  
 balanced section, that is the balance Bending should not be greater than  $\frac{1}{4} Qbd^2$ .

The beam may be checked for bond and shear, and shear reinforcement may be designed on  
 the same principle as for ordinary rectangular beam.

**R.C.C.T.-Beam**—When the slab and beam are combined by concreting monolithically  
 (simultaneously), the slab acts jointly with the beam to resist compression and the combination  
 forms a T-shape known as T-beam.

Breadth of slab or flange  $b$ , of the T-beam is taken as least of the following:—

(i) Centre to centre of beam i.e. spacing of beam, (ii) 12 times the depth of the slab plus breadth  
 of the rib i.e.  $12 d_s + b_r$ , (iii)  $\frac{1}{3}$  span of the beam.

Effective depth of the beam  $d$  from the top of slab up to centre of the bar may be assumed as (i)  
 $\frac{1}{15}$  to  $\frac{1}{20}$  span for light load, (ii)  $\frac{1}{12}$  to  $\frac{1}{15}$  span for medium load, (iii)  $\frac{1}{10}$  to  $\frac{1}{12}$  span for  
 heavy load.

Breadth of the rib  $b_r$  is taken .5 to .7 times effective depth,  $b_r$  should be such as to accommodate  
 the bars but should not be less than  $\frac{1}{3}$  total depth of rib below slab.

**Design**—(1) Find B.M. for total load, both live load and dead load, B.M. =  $Wl^2/8$ . (2) Assume  
 depth  $d$ ,  $\frac{1}{12}$  to  $\frac{1}{20}$  span (take  $\frac{1}{15}$  span). Take  $b_r = .6 d$ . (3) Find  $b$ , the least of (i)  $c$  to  $c$  of beam,  
 (ii)  $12 d_s + b_r$ , (iii)  $\frac{1}{3}$  span. (4) Take lever arm  $a = d_c - .4d$  or  $.9d_c$ . (5) Find area of tension steel  $A_t$  from  
 B.M. =  $A_t \times a$ . (6)  $A_t$  being found choose dia of bar and find number.

**Check**—Find actual lever arm and calculate the M.R. for compression and M.R. for tension,  
 which should not be less than B.M. due to external load, but slightly greater.

M.R. for compression =  $[b \cdot d_c \times \frac{1}{2} (c + c')] \times \text{lever arm}$  :-

M.R. for tension  $A_t \times \text{lever arm}$ ; Lever arm =  $d - \bar{y}$ .

$y = \frac{c + 2c'}{3} \times \frac{d_c}{n}$ ,  $c' = \frac{c(n - d_c)}{n}$ . The position of the neutral axis  $n$  may be found from  $b \cdot d_c \cdot (n - \frac{d_c}{2})$   
 =  $m A_t (d - n)$ , only  $n$  is unknown. If not safe on check redesign by assuming greater depth.

Shear and bond may be checked and shear reinforcement may be designed on the same  
 principle as rectangular beam. First slab is designed as continuous slab taking Bending Moment as  
 $Wl^2/12$  or  $Wl^2/10$  and then T-beam is designed.

**Design of R.C.C. Columns.**—Columns are designed to carry the total load. The longitudinal  
 reinforcement should not be less than 0.8% nor more than 8% of gross sectional area of the column.  
 The transverse or lateral reinforcement should not be less than 0.4% of gross volume of column.

**Short Columns.**—  $\frac{\text{Effective length}}{\text{Dia. or least lateral dimension}}$  is less than 15.

**Short column with independent or separate lateral ties.**—Axial permissible load  $P = cA +$   
 $t A_s$

**Short column of helical ties.**—Axial permissible load  $P = cA_k + t_c A_s + 2 t_b + A_b$  where  
 $t_c$  = permissible stress in concrete in direct compression (for 1:2:4 concrete  $c = 48 \text{ kg/sq cm}$ ),  
 $A_k$  = cross-sectional area of concrete excluding steel,  $t_c$  = permissible compressive stress in steel,  
 $t_b = 1200 \text{ kg/sq cm}$ ,  $A_s$  = cross-sectional area of longitudinal steel.

$A_k$  = cross-sectional area of concrete in core of column excluding longitudinal steel,  
 $t_b$  = permissible stress in helical reinforcement (1000 kg/sq cm),  $A_b$  = equivalent area of  
 helical bars =  $\frac{\text{circumference of core} \times \text{sectional area of helical bar}}{\text{one pitch}}$

**Design.**—For designing find the external load  $P$ , assume suitable size of column to keep  $H$   
 within short column and find  $A_s$  by formula  $P = cA + t_c A_s$

**Long columns.**—  $\frac{\text{Effective length}}{\text{Dia. or least lateral dimension}}$  is greater than 15.

Long column is designed as short column by multiplying the permissible load by a reduction  
 co-efficient. The reduction co-efficient  $C_r = 1.5 - \frac{l}{30 D}$  where  $l$  = effective length of column.

$D$  = diameter or least dimension of column.

When the ratio of the effective length of column to least lateral radius of gyration, is above 50,  
 then the reduction co-efficient  $C_r = 1.5 - \frac{l}{100r}$

Permissible load on long column = Permissible load on short column  $\times$  reduction co-efficient.  
 For designing a long column find the external axial load and divide by the reduction co-efficient  
 and design as short column to carry the increased load. At an illustration if the load coming on  
 column is 100 tonne and the column is a long one and reduction co-efficient is 0.5 then design the  
 column as short column to carry a load of  $\frac{100}{0.5} = 200$  tonne.

**Usual requirement of longitudinal steel.**—Cross sectional area of steel  $A_s$  should not be less  
 than 0.8 per cent nor more than 8 per cent of gross-sectional area of column. Diameter of bar should  
 not be less than 12 mm nor more than 50 mm.

**Transverse or independent lateral reinforcement.**—Volume of independent laterals should  
 not be less than 0.4 of gross volume of column. Diameter of laterals shall not be less than 5 mm. The  
 pitch or distance shall not be more than the least value of the following:—

(a) Least lateral dimension of column, (b) 12 times the diameter of longitudinal bars, (c) 30  
 centimetre.

**Helical reinforcement.**—Volume of helicals should not be less than 0.4 per cent of gross  
 volume of column. Diameter of helicals should not be less than 5 mm. Pitch shall be:—

(i) not less than 7.5 mm, (ii) not more than  $\frac{1}{6}$  of core diameter of column, (iii) not less than  
 25 mm, (iv) not less than 3 times the diameter of helical bars.

R.C.C. COLUMNS  
REINFORCEMENT AND LATERAL TIES

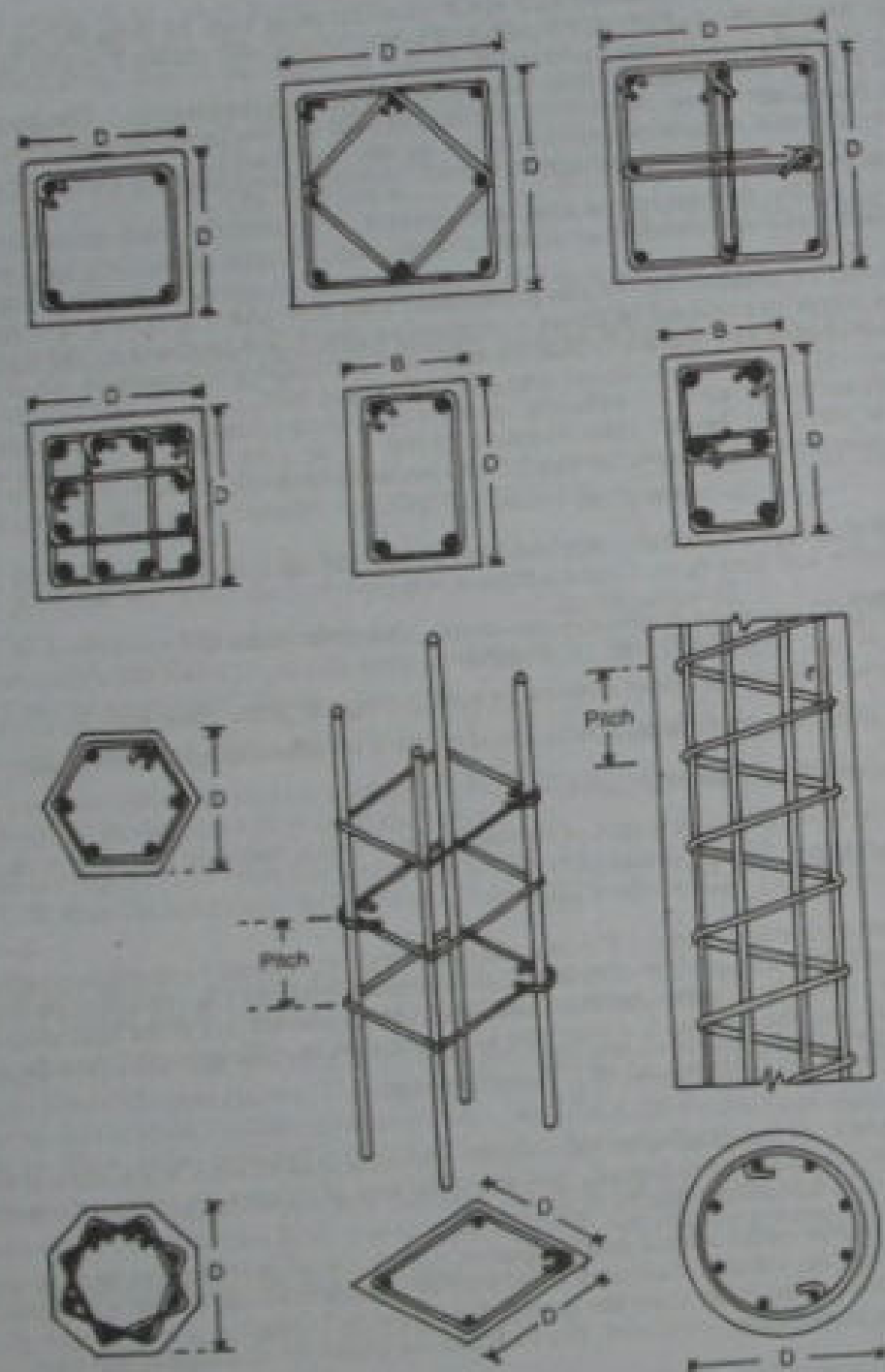

Fig. 16-1

Stresses, Weights, etc. in Metric and F.P. System —

Stress	F.P. Unit	Metric Units	Stress	F.P. Unit	Metric Units
(compressive)	600 lbs/sq in.	42.00 kg/sq cm	t (Tensile)	13500 lbs/sq in.	945 kg/sq cm
	750 "	52.50 "		16000 "	1120 "
	800 "	56.00 "		18000 "	1260 "
	1000 "	70.00 "		20000 "	1400 "
s (shear)	75 lbs/sq in.	5.25 kg/sq cm	Sb (bond)	100 lbs/sq in.	7.00 kg/sq cm
	80 "	5.60 "		120 "	8.40 "
	90 "	6.30 "		150 "	10.50 "
Ec	2 × 10 <sup>4</sup> lbs/sq in.	1.4 × 10 <sup>6</sup> kg/sq cm	Es	30 × 10 <sup>4</sup> lbs/in	21 × 10 <sup>6</sup> kg/sq cm
Wt. of c.c.	114 lbs/cu ft.	2300 kg/cu m.	Wt. of masonry	120 lbs/cu ft.	1920 kg/cu m
Wt. of R.C.C.	150 "	2400 "		130 "	2080 "
Wt. of earth	100 "	1600 "	Wt. of mild steel	490 lbs/cu ft.	7850 kg/cu m
	110 "	1760 "	Wt. of water	62.4 lbs/cu ft.	1000 kg/cu m

Water for cement concrete. — Quantity of water for ordinary concrete mix should be equal to 5 per cent by weight of total aggregate (coarse and fine) plus 30 per cent by weight of cement. For vibrated concrete the quantity of water should be reduced by 20 per cent.

Weight of plain cement concrete may be taken as 2300 kg/cu m and weight of reinforced cement concrete may be taken 2400 kg/cu m. Weight of ordinary portland cement is equal to 1440 kg/cu m (90 lb/cu ft).

Water Cement Ratio, Slump and Strength for 1:2:4 Cement Concrete —

Water cement ratio	Water per bag	Slump	Compression strength in 28 days	
535	27.3 litre 6 gls.	5.0 cm 2"	5000 lbs/sq in.	350 kg/sq cm
58	29.5 litre 6½ gls.	5.5 cm 2¼"	4250 "	297 "
625	31.8 litre 7 gls.	16.5 cm 6½"	3800 "	266 "
67	34.1 litre 7½ gls.	17.5 cm 7"	3300 "	231 "
714	36.4 litre 8 gls.	21.5 cm 8½"	3000 "	210 "

Slump for different work —

Slump	Workability	Suitable for Works
2.5— 5 cm (1"—2")	Low	Pavement, Roads, Dams, Precast.
5—10 cm (2"—4")	Medium	Building Works, Arches, Walls Steps, Bridges, Piles.
10—15 cm (4"—6")	High	R.C.C. Works, Beams, Slabs, Lintels, Columns.

Steel Reinforcement bars. — The steel used as reinforcement are generally of round bars of several types as Mild steel, Medium tensile steel, Hard drawn steel, High tensile steel, etc. These types of steel differ slightly from each other in chemical composition and the process of manufacture also differs. The steel should be chosen to have the smallest section of structure and to be most economical.

Deformed bars. — Latest development is the use of deformed steel bars. The deformed bars have some type of corrugations, projections or indentations on the surface which increases the



bond. The permissible tensile stresses in the deformed bars may be higher by 50% or more. For deformed bars working stress of 1900 kg/sq cm may be taken for tension. Deformed bars are now mostly used in advanced countries. Design principle is same as for round bars. There are different types of deformed bars which are being manufactured by different manufacturers. Deformed bars may be cold twisted bars or Hot rolled deformed bars. The cold bars may be of a Single Square Twisted Bar or a Twin Twisted Bar. The hot rolled deformed bars are usually ribbed type having projections and indentations. A few types of deformed bars are illustrated below:—

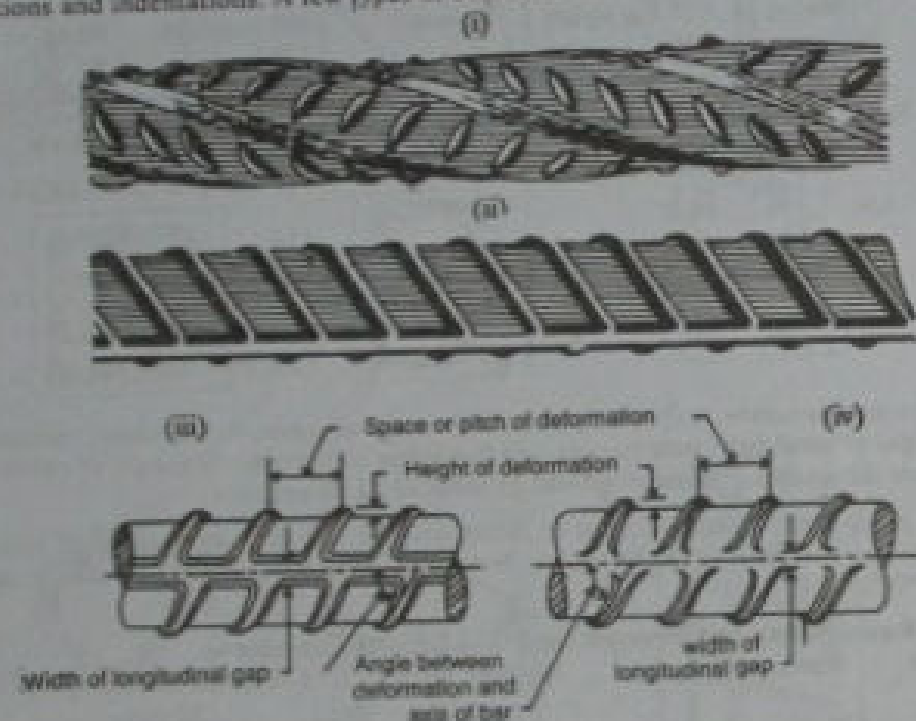

Fig. (i) Cold twisted high yield strength ribbed bars. (Manufactured by Tata Iron & Steel Co.)  
 Fig. (ii) Hot rolled high yield strength ribbed bars. (Manufactured by Tata Iron & Steel Co.)  
 Fig. (iii) and (iv) Hot rolled ribbed bars as recommended by Indian Standard Institution.

**Economy in the cost of R.C.C. structures by using High-strength and high-bond steel reinforcement** — High yield strength deformed steel, because of its high strength and high bond characteristic is gradually replacing the conventional mild steel in R.C.C. structures. The use of high-strength and high bond steel is quite sound as it effects considerable economy. Due to high bond characteristic of this variety of steel, it may not be necessary to provide the hooks and overlaps as the joints may be much reduced. It is however desirable to join the deformed bars by welding. There will be a saving in steel of about 40% by using High-strength and High-bond steel as compared to the mild steel rounds.

The equivalent high yield strength steel diameters given below may be substituted in place of mild steel bars retaining dimensions of section, quantity of concrete, spacing of bars, etc. the same as with mild steel, reinforcement design with any change.

Rectangular beams, slabs, (one-way or two-way reinforced), T-beams and columns with loads other than concentric loads.

	Tension reinforcement										
Mild steel dia. mm	8.00	10	16.00	20	22	25	28	32	36	40	50
Ribbed torsteel dia. mm	6.25	8	12.50	16	18	20	22	25	28	32	40
	Compression reinforcement										
Mild steel dia. mm...	12	16	20	22	25	28	32	36	40	50	
Ribbed torsteel dia. mm	10	14	2×12	18	20	22	2×18	2×20	32	40	

**Design of Timber Beam** — Timber beam is designed for maximum bending moment  $B.M. = \frac{wl^2}{8} = M$ .  $M = fz = f \times \frac{1}{6} bd^2$ , where  $d$  = depth of beam,  $b$  = breadth of beam = 5 to .75 depth, and  $f$  = safe compressive stress of timber. For sal wood  $f = 105$  kg/sq cm (1500 lbs/sq in), and for Indian teak wood  $f = 100$  kg/sq cm (1400 lbs/sq in). Calculate load per metre on the beam inclusive of live load and dead load of roof, then find B.M. and design.

**Thumb rule for wooden beam** — Depth of beam =  $1/25$  span + 5 cm (or 2") For 3 metre span, depth of beam =  $\frac{300}{25} + 5 = 17$  cm,  $b = 0.6 \times 17 = 10.2$  cm = 10 cm.

**Illustration** — Effective span of a wooden beam is 5 m, and load has been calculated at 6 tonne per metre.  $B.M. = \frac{wl^2}{8} = \frac{16000 \text{ kg} \times 5 \times 5 \times 100}{8} = 5,00,000$  kg cm.  $M = f \times \frac{1}{6} bd^2$  or  $500000 = 100 \times \frac{1}{6} \times 0.6d \times d^2$  assuming  $b = 0.6d$  or  $d = 50000$ . Therefore,  $d = 37$  cm,  $b = 37 \times 0.6 = 22.2$  cm. The size of the beam is 22.2 cm × 37 cm.

**Steel Beam** —  $B.M. = \frac{wl^2}{8} = M = fz = \frac{M}{f} \times z$  = section modulus. Where  $f$  = safe compressive bending stress of steel = 1400 kg/sq cm (9 ton/sq in). In steel table the section modulus for different section of beams are given. Calculate section modulus and consult steel table and choose suitable section of beam.

**Illustration** — Effective span of a beam is 8 m and load has been calculated as 2 tonne per metre.  $M = B.M. = \frac{wl^2}{8} = \frac{2000 \times 8 \times 8 \times 100}{8} = 16,00,000$  kg cm. Section modulus  $z = \frac{M}{f} = \frac{1600000}{1400} = 1143$  cm<sup>3</sup>. From steel table section modulus —

- (i) I-section 400×200 mm @ 66.7 kg/m, section modulus = 1171.3 m<sup>3</sup>
- (ii) I-section 350×250 mm @ 72.4 kg/m, section modulus = 1131.6 m<sup>3</sup>
- (iii) I-section 450×170 mm @ 65.3 kg/m, section modulus = 1223.8 m<sup>3</sup>

Any one of these section may be chosen.

**Steel stanchions or columns** — The steel stanchions or strut members are designed by Rankine's formula —  $P = \frac{fA}{1 + \frac{f}{\alpha} \left(\frac{l}{k}\right)^2}$  or  $\frac{P}{A} = f = \frac{f}{1 + \frac{f}{\alpha} \left(\frac{l}{k}\right)^2}$

where  $f$  = safe compressive stress of steel;  $f$  = safe stress for the particular stanchion;  $A$  = sectional area of stanchion;  $l$  = effective length of stanchion;  $k$  = least radius of gyration;  $\alpha$  = constant (Rankine's constant);  $P$  = safe load the stanchion can carry.

Calculate the load coming on the stanchion. Assume a suitable section of steel and calculate the safe stress for the particular stanchion from  $f = \frac{fc}{1 + a \left(\frac{l}{k}\right)^2}$ .

$P = Af$ , or  $Pf = A$ . Divide the load  $P$  by  $f$  and find sectional area  $A$  and compare with the section chosen. If not satisfied choose some other section and repeat, until a suitable section is arrived at.

The above formula is for both ends hinged, for other conditions of ends the length  $l$  may be taken as —

(i) For one end fixed and the other end free,  $l = 2l$  or  $a = 4a$ .

(ii) For both end fixed,  $l = \frac{l}{2}$  or  $a = \frac{a}{4}$ .

(iii) For one end fixed and one hinged,  $l = \frac{l}{\sqrt{2}}$ ,  $l$  or  $a = 4/9a$ .

For storeyed building both ends of stanchion are considered as fixed for other cases one end hinged and one end fixed.

For roof truss the forces on the members are determined by stress diagram or by analytical method.

The struts are designed on the same basis by Rankine's formula.

For stanchions or struts other empirical straight line formula may also be used.

For tension member the total load or force  $W$  on the member divided by safe tensile stress gives the sectional area. Net sectional area =  $\frac{W}{ft}$ , where  $ft$  = safe tensile stress. The rivet holes should be

deducted from the gross sectional area to get the net sectional area. After calculating section area, consult steel table and choose suitable section of angle iron or flat bar.

**Flooring.** — For residential building floor may be 2.5 cm (1") thick cement concrete 1 : 2 : 4 and for non-residential building, schools, offices and factories, the floor should be 4 cm (1½") thick cement concrete. The floor of 1st floor, 2nd floor, etc. over R.C.C. slab should be 4 cm (1½") cement concrete 1 : 2 : 4. The floor, should be finished with neat cement coating. Decorative floor finish as mosaic and coloured, and other type of floor finish may be given as desired.

**Thickness of wall.** — The thickness of wall depends on its height, length and load it has to support. For one storeyed residential building upto 3.7 m (12") height, the wall may be one brick 20 cm (9") thick. For rooms bigger than 5 m (14") in length the wall should be 1½ brick, 30 cm (13½") thick. For two storeyed building the wall of ground floor should be 1½ brick, 30 cm (13½") thick and 1st floor may be 1½ brick, 30 cm (13½") thick and the wall of 2nd floor may be one brick, 20 cm (9") thick. The three storeyed building having big rooms, the 2nd floor may be one brick, 20 cm (9") thick. The three storeyed building having big rooms, the ground floor wall should be two brick 40 cm (18") thick and the 1st floor and 2nd floor walls should be 1½ brick 30 cm (13½") thick. Partition walls may be ½ brick, 10 cm (4½") thick in cement mortar 1 : 3 to 1 : 4 with hoop iron or equivalent reinforcement at every fourth layer. Multi storeyed building should be of R.C.C. framed or steel framed structure with walls of one brick 20 cm (9") thick. To prevent weather effect the outer walls may be of hollow or cavity wall.

**1. Population.** — The population figures should be determined for a design of 30 years plus a long period of 3 to 5 years which may be calculated by Arithmetical increase, Geometric increase or

by comparative trend of increase in similar towns or potentialities of development of the town.

**2. Rate of Water Supply.** — The rate of water supply should be the same on which basis the water supply scheme has been designed or on which a reorganization scheme is likely to be designed in the near future or on which basis a water Supply Scheme if prepared now will have to be designed.

**3. Spent Water.** — Spent water to reach the sewer shall be 75% of per capita water supply. In case of sewers under sub-soil in summer season a minimum infiltration @ 3000 g.p.d. per inch per mile should be adopted and if site conditions require any variation, approval of the competent authorities may be taken. In the hills due to climatic condition the spent water may be taken as 10%.

**4. Flow Criteria.** — (a) All laterals branches and outfall sewers should be designed for the peak flow at the rate of 3 times D.W.F. below 1 lakh population. The outfall may be designed for 2.5 D.W.F. If the population contributing to flow in the outfall sewer is more than 10 lakhs.

(b) Sewers of 15" dia. and below should be designed to run about half full at the peak flow.

(c) Sewers of 18" dia. and above should be designed to run about 2/3 rd full at the peak flow.

(d) The designed peak flow level of sillage in branch sewers should be at a higher level but in no case less than that of the designed peak flow level in main sewer.

**5. Velocity.** — (a) Minimum velocity should not be less than, 2 ft. per second for all types of sewers during peak flow at the beginning of the design period except in 6" and 9" dia. sewers where it may be less provided flushing is provided and a flushing velocity of 2.5 ft per second is achieved during flushing.

(b) Minimum velocity at the end of design period during peak hours shall not be less than 2.5 ft per second except 6" and 9" dia sewers as discussed above.

(c) Maximum velocity shall not exceed 8 ft per second even carrying full bore discharge for brick and concrete sewers. In the case of cast iron sewers it may be restricted to 15 ft/sec.

Flushing wherever required, should be done with the help of mobile flushing tanks.

**6. Kind of Pipe.** — R.C.C. pipes of 6" to 36" dia. shall be used for sewers up to 36" dia. Above this brick sewers or concrete pipes may be proposed depending upon depth of cutting, width of road and depth of sub-soil water over the sewer.

**7. Formula to be used for Design.** — Kutters and Gangnicolis formula with value of 'n' as given below shall be used :—

$n = 0.010$  for stone ware pipes  $n = 0.013$  for concrete and well laid plastered brick sewers,  
 $n = 0.015$  for average brickwork in sewers,  $n = 0.017$  for cast iron sewers.

**8. Spacing of Manholes.** — Maximum spacing between two consecutive manholes should be as given below :—

(a) Laterals	6" to 9" Dia.	150 ft. spacing
(b) Branches	12" to 15" Dia.	250 ft. spacing
(c) Mains	18" and above Dia.	3000 ft. spacing

**9. Manholes.** — (a) Less than 10 ft deep — Slab type. (b) More than 10 ft. deep — Arch and Shaft type. (c) Benching shall be 9" to 1 ft.

10. *Shafts*. — (a) The size of House Connecting Chambers should be 3' x 2' and Sewer Connecting Shafts may be 2' x 2' and should be provided in between two consecutive manholes depending upon the location of private and public latrines. Normally in congested areas the distance in between the shafts or shaft and a manhole should be about 75'. In areas like civil lines which are thinly populated, location of shafts can be deleted altogether and in sparsely populated areas the spacing may be suitably increased.

(b) The sewer connecting shafts need not be proposed to be constructed upto G.L. but may be left at a height so that the house connecting chambers may easily be connected.

11. *Ventilators*. — These should be provided at the head of every sewer and at an average spacing of 600 ft and 1000 ft for outfall and intercepting sewers respectively.

12. *Sump well*. — Normally, holding capacity of sump will be of 10 mts. D.W.F. of bigger installations and 30 mts. D.W.F. for small installation.

13. *Pump*. — Design of pumps for peak and non-peak flows should be done according to the size of the town. In smaller towns stand by should be about 50% and for bigger installations about 25 to 35% if the difference of lift for storm water and normal sewage is much, separate pumps for both should be provided.

14. *Rising main*. — It should be designed to get minimum velocity of 1' per second at minimum flow and also 3' per second for peak flow and on the economic consideration.

15. *Sewage farming*. — (a) In case sewage farming is proposed, quantity of sewage required to irrigate one acre of land for normal condition of soil shall be taken as 1000 gallons per day. Provision for 10% extra land shall be made for the construction of road, channels and gools, etc.

(b) An income of about Rs. 1000/- to 1500/- per acre shall be assumed for the purpose of calculating the economics. These figures will apply when land is owned by the Board.

One-roomed quarters with box room for driver and one room quarter for each of the pump attendants, chowkidar and sweepers shall be proposed.

16. *Maintenance*. — The following maintenance staff should be proposed :—

- (a) One Pump Driver for each pumping station.
- (b) One Pump Attendant-cum-cleaner per shift for pumping station.
- (c) One Number Chowkidar for each pumping station.
- (d) One Sweeper at each pumping station and at least two at the Sewage Farm.
- (e) Gang of Sweepers depending upon the size of town.

#### PRINCIPLE FOR THE PREPARATION OF WATER SUPPLY SCHEME

1. *Selection of source*. — Where raw water from flowing streams, lakes, tanks and other impoundment from contaminated catchments and ponds form the source, provision should be made in the scheme for filtering such water prior to disinfection.

2. *Quality of water*. — The chemical quality of supplies proposed from ground water through tube wells, well and infiltration works should be of acceptable quality, to be adjudged with reference to local condition. Where special treatment of removal of dissolved substance like iron, sulphates and fluorides is necessary, provision should be made there in the scheme.

3. *Disinfection*. — It is advisable to provide for continuous effective disinfection of supplies drawn through tube wells, wells and infiltration works where local conditions indicate the need.

Where surface water is the source, treatment including filtration and disinfection of the final effluent is essential.

It is equally important to ensure that the free residual chlorine of a minimum of 0.2 ppm is maintained at all points in the distribution system.

4. *Simple drip-feed device*. — For simple rural well supplies, disinfection should be arranged by a simple and economical drip feed of a decanted bleaching powder solution, the dosage being adjusted to suit the rate of draw from the source. A simple gravity feed arrangement for such a purpose should be followed.

5. *Pressure-feed chlorinators*. — There are different types of pressure-feed chlorinators available for injecting chlorine solution into force mains. The two good classification of these chlorinators are—

- (a) the positive-feed type, and
- (b) the vacuum type.

The details of their working and operation, and the care of chlorinator equipment are set out in paras 10-6-22 and 10-6-3 on pages 132-136 of the Manual on Water Supply issued by the Ministry of Health.

Common defects and handicaps experienced in operating some of the pressure-type chlorinators in the market are to be attributed to the provision of inferior rubber holders, mal-adjustments of the plunger stroke and inferior types of rubber diaphragm. Every care should be exercised in selecting a good and robust quality of chlorinator suited to the needs of each case.

6. *Structure of infiltration galleries*. — In developing safe supplies through infiltration works the essential details to be followed in the design of infiltration galleries have been set out in the Water Supply Manual.

7. *Slow sand filter*. — Where slow sand filtration is adopted for treatment of raw water, the design criteria to be adopted are as set out in the Water Supply Manual. A typical design calculation to determine the economical size of filters is given in the following page.

8. *Type design of iron removal plant*. — A typical design of an iron-removal plant should be followed. The basic factors governing the design of such plants are set out in the Water Supply Manual. These may be adopted with suitable modification where removal of iron from ground or surface water is necessary.

9. *Mechanical filter plants*. — Where full-scale treatment of raw water comprising chemical design mixing, flocculation, sedimentation and filtration followed by disinfection is necessary, the functional aspect of each component as well as the design criteria recommended in respect of each, as set out in the Water Supply Manual may be adopted with suitable modification.

10. *Economical size for source mains*. — The per capita rate of supply to be adopted in respect of each community, the most economical means of conveyance of the supply from the source to the service points and the design of the distribution system in each case may generally follow the guide-lines set out in the Water Supply Manual.

11. *Charts for pipe flow computation*. — It is recommended that Hazen and William's Formula should be adopted in the design of pressure mains while the Kutter's Formula or the Manning's Formula should be used for free-flow conduits. Readymade charts for computing pipe size under the Hazen and William's and Kutter's Formulae may be used.

The Hazen and William's Chart is based on a value of 100 for 'C'. For other values of 'C' applicable to different pipe materials (as recommended in the Water Supply Manual), the corresponding figures will have to be deducted.

The Kutter's Charts are for a value of  $n = .015$  which may be adopted for all pipes upto 24" dia. and masonry conduits of all sizes. A value of  $n = .013$  may be used for pipes above 24" dia.

### DESIGN OF ECONOMIC SIZES OF SLOW SAND FILTER BEDS

Assuming that every 4 beds an additional space bed is provided and the rate of filtration of 50 gallons per sq ft. per day 2 gals. per sq ft. per hour approximately is adopted, the size and arrangement of beds for dealing with a daily quantity of say 1 mgd. is calculated as follows:—

$$\text{Total area of bed required for filtration at a time} = \frac{1,000,000}{50} = 20,000 \text{ sq ft.}$$

$$\text{Adopting 4 effective beds, area of each bed} = \frac{20,000}{4} = 5,000 \text{ sq ft.}$$

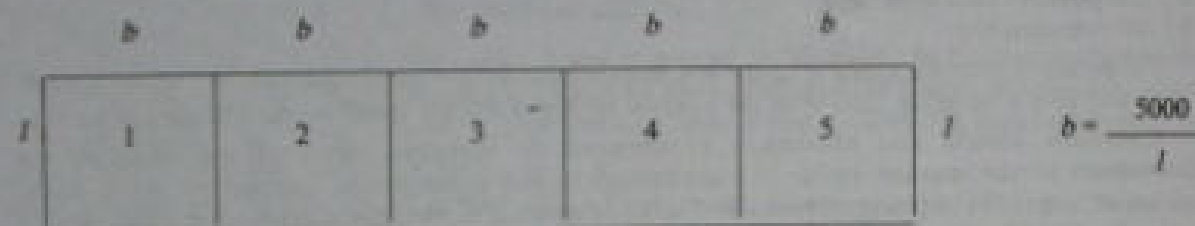

Consider the beds continuous with two outer long walls and two end walls and four partition walls making five beds as shown in above sketch.

$$\text{Let } 'l' \text{ be the length of each, then bed width } b \text{ of each bed} = \frac{5000}{l}$$

$$\text{Total perimeter of wall for 5 beds} \quad p = 6l + \frac{10 \times 5000}{l}$$

$$\text{For minimum total perimeter, } \frac{dp}{dl} = 0, 6 - \frac{50,000}{l^2} = 0, \text{ or } l^2 = \frac{50,000}{6} = 8333$$

$$\text{Therefore } l = \sqrt{8333} = 91.38 \approx 90 \text{ ft (say) and width } b = \frac{5000}{90} = 56 \text{ ft.}$$

The dimension of each bed will be 90 ft  $\times$  56 ft.

### BRIDGES AND CULVERTS

**Discharge.**—Discharge may be calculated by various methods and maximum value may be taken for design of water way. The different methods of calculation of discharge are as follows:—

**1. Sectional area of stream and velocity method.**—Discharge  $Q = AV$ .  $A$  = Mean cross-sectional area of stream at highest flood level, which may be determined by taking three cross-sections at the site of the bridge, one at the up-stream side and one at the down-stream side and one about 3/4 kilometre from the site,  $V$  = mean velocity during highest flood level which may be determined by—

(i) Direct observation by float or by current meter or by pilot tube. Mean velocity =  $0.8 \times V$ , where  $V$  = surface velocity.

(ii) Chezy's Formula  $v = c \sqrt{m i}$ , where  $m$  = hydraulic mean depth,  $i$  = bed slope of river.  $c$  = constant = 100 for large rivers and 68 for small rivers.

The constant value of  $c$  may also be determined by—

- (a) **Kutter's Formula** —  $c = \frac{41.66 \frac{80281}{i} + \frac{1.811}{f}}{1 + (41.66 + \frac{80281}{i}) \frac{f}{\sqrt{m}}}$  where  $f$  = co-efficient of roughness or rugosity of river bed = 0.020 to 0.035 for bed ranging from firm ground to ordinary earth.
- (b) **Bazin's Formula** —  $c = \frac{157.6}{1 + \frac{n}{\sqrt{i}}}$ ;  $n$  = co-efficient = 2.36 for very rough ordinary earthen channel, and = 3.17 for very rough channel with weeds, boulders, etc.
- (c) **Manning's Formula** —  $v = \frac{1.4858}{n} \times m^{2/3} i^{1/2}$

For the following methods catchment area shall have to be determined from the maps or by surveying.

**2. Dicken's formula.**—Discharge  $Q = CM^{3/4}$ , where  $Q$  = run off in cusecs, and  $M$  = catchment area in sq miles, and  $C$  = co-efficient = 800 to 1000 where the annual rain fall is 25" to 50",  $C$  = 1000 to 1400 in Madhya Pradesh and  $C$  = 1600 in Western Ghats.

**3. Ryve's Formula.**—Discharge  $Q = CM^{2/3}$ , where  $Q$  = run off in cusecs, and  $M$  = catchment area in sq miles, and  $C$  = co-efficient = 450 for areas within 15 miles of the coast,  $c$  = 563 for areas between 15 to 100 miles of the coast and  $c$  = 673 for limited areas near hills.

**4. Inglis formula.**—Discharge  $Q = \frac{7000M}{\sqrt{M+4}}$ ;  $Q$  = run off in cusecs, and  $M$  = catchment area in sq miles.

**5. American formula.**—Discharge  $Q = C_l c S^{1/2} A^{3/4}$ , where  $Q$  = peak run off in cusecs,  $S$  = fall in feet per 100 ft length of the main channel of flow,  $A$  = area of basin in acres,  $c$  = critical intensity of rain fall in inches per hour,  $C$  = 0.30 for thinly populated and unpaved suburbs with gardens and lawns,  $C$  = 0.40 for towns not densely built upon.

**6. Rainfall and catchment area method for small catchment.**—Discharge  $Q = PAIc$ , where  $Q$  = Maximum run off in cusecs,  $A$  = area of catchment in acres,  $I_c$  = critical intensity of rainfall in inches per hour,  $P$  = percentage co-efficient of run-off for the catchment characteristics: (i) For steep, bare rock and city pavements  $P = 0.90$ ; (ii) For Rock steep but wooded  $P = 0.80$ ; (iii) For plateaus lightly covered  $P = 0.70$ ; (iv) For claye soil stiff and bare  $P = 0.60$ ; (v) For clay soil lightly covered  $P = 0.5$ ; (vi), For loam, lightly cultivated or covered  $P = 0.40$ ; (vii) For loam largely cultivated  $P = 0.30$ ; (viii) For sandy soil, light growth  $P = 0.20$ ; (ix) For sandy soil, covered heavy bush  $P = 0.10$  (Refer—Design of small Bridges and Culverts by Govardhanlal).

### WATERWAY AND SPAN FOR BRIDGES AND CULVERTS

**Waterway.**— $a = Q/v$ ,  $a$  = sectional area of waterway,  $Q$  = Design discharge or Run off,  $v$  = velocity of flow.